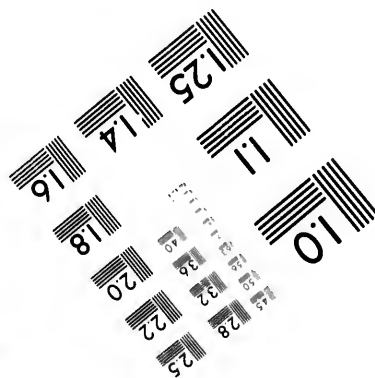
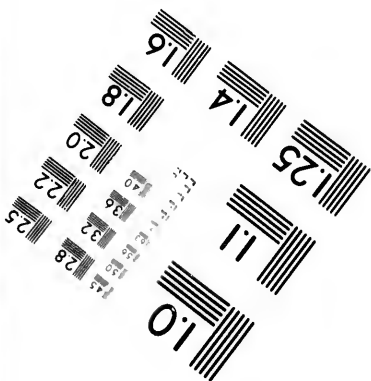
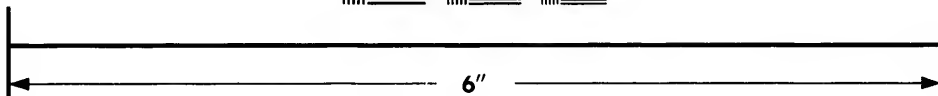
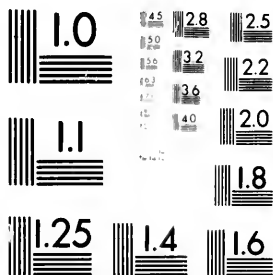

**IMAGE EVALUATION  
TEST TARGET (MT-3)**



Photographic  
Sciences  
Corporation

23 WEST MAIN STREET  
WEBSTER, N.Y. 14580  
(716) 872-4503

2.5  
2.8  
3.2  
2.2  
2.0

**CIHM/ICMH  
Microfiche  
Series.**

**CIHM/ICMH  
Collection de  
microfiches.**

01



**Canadian Institute for Historical Microreproductions**

**Institut canadien de microreproductions historiques**

**1980**

Technical and Bibliographic Notes/Notes techniques et bibliographiques

The Institute has attempted to obtain the best original copy available for filming. Features of this copy which may be bibliographically unique, which may alter any of the images in the reproduction, or which may significantly change the usual method of filming, are checked below.

L'Institut a microfilmé le meilleur exemplaire qu'il lui a été possible de se procurer. Les détails de cet exemplaire qui sont peut-être uniques du point de vue bibliographique, qui peuvent modifier une image reproduite, ou qui peuvent exiger une modification dans la méthode normale de filmage sont indiqués ci-dessous.

Coloured covers/  
Couverture de couleur

Covers damaged/  
Couverture endommagée

Covers restored and/or laminated/  
Couverture restaurée et/ou pelliculée

Cover title missing/  
Le titre de couverture manque

Coloured maps/  
Cartes géographiques en couleur

Coloured ink (i.e. other than blue or black)/  
Encre de couleur (i.e. autre que bleue ou noire)

Coloured plates and/or illustrations/  
Planches et/ou illustrations en couleur

Bound with other material/  
Relié avec d'autres documents

Tight binding may cause shadows or distortion  
along interior margin/  
La reliure serrée peut causer de l'ombre ou de la  
distortion le long de la marge intérieure

Blank leaves added during restoration may  
appear within the text. Whenever possible, these  
have been omitted from filming/  
Il se peut que certaines pages blanches ajoutées  
lors d'une restauration apparaissent dans le texte,  
mais, lorsque cela était possible, ces pages n'ont  
pas été filmées.

Additional comments:/  
Commentaires supplémentaires:

Coloured pages/  
Pages de couleur

Pages damaged/  
Pages endommagées

Pages restored and/or laminated/  
Pages restaurées et/ou pelliculées

Pages discoloured, stained or foxed/  
Pages décolorées, tachetées ou piquées

Pages detached/  
Pages détachées

Showthrough/  
Transparence

Quality of print varies/  
Qualité inégale de l'impression

Includes supplementary material/  
Comprend du matériel supplémentaire

Only edition available/  
Seule édition disponible

Pages wholly or partially obscured by errata  
slips, tissues, etc., have been refilmed to  
ensure the best possible image/  
Les pages totalement ou partiellement  
obscurcies par un feuillet d'errata, une pelure,  
etc., ont été filmées à nouveau de façon à  
obtenir la meilleure image possible.

This item is filmed at the reduction ratio checked below/  
Ce document est filmé au taux de réduction indiqué ci-dessous.

10X	14X	18X	22X	26X	30X
<input type="checkbox"/>	<input type="checkbox"/>	<input type="checkbox"/>	<input type="checkbox"/>	<input checked="" type="checkbox"/>	<input type="checkbox"/>
12X	16X	20X	24X	28X	32X

The copy filmed here has been reproduced thanks to the generosity of:

Harold Campbell Vaughan Memorial Library  
Acadia University

The images appearing here are the best quality possible considering the condition and legibility of the original copy and in keeping with the filming contract specifications.

Original copies in printed paper covers are filmed beginning with the front cover and ending on the last page with a printed or illustrated impression, or the back cover when appropriate. All other original copies are filmed beginning on the first page with a printed or illustrated impression, and ending on the last page with a printed or illustrated impression.

The last recorded frame on each microfiche shall contain the symbol  $\rightarrow$  (meaning "CONTINUED"), or the symbol  $\nabla$  (meaning "END"), whichever applies.

Maps, plates, charts, etc., may be filmed at different reduction ratios. Those too large to be entirely included in one exposure are filmed beginning in the upper left hand corner, left to right and top to bottom, as many frames as required. The following diagrams illustrate the method:

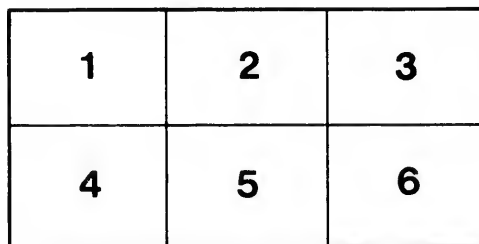
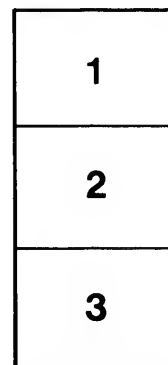

L'exemplaire filmé fut reproduit grâce à la générosité de:

Harold Campbell Vaughan Memorial Library  
Acadia University

Les images suivantes ont été reproduites avec le plus grand soin, compte tenu de la condition et de la netteté de l'exemplaire filmé, et en conformité avec les conditions du contrat de filmage.

Les exemplaires originaux dont la couverture en papier est imprimée sont filmés en commençant par le premier plat et en terminant soit par la dernière page qui comporte une empreinte d'impression ou d'illustration, soit par le second plat, selon le cas. Tous les autres exemplaires originaux sont filmés en commençant par la première page qui comporte une empreinte d'impression ou d'illustration et en terminant par la dernière page qui comporte une telle empreinte.

Un des symboles suivants apparaîtra sur la dernière image de chaque microfiche, selon le cas: le symbole  $\rightarrow$  signifie "A SUIVRE", le symbole  $\nabla$  signifie "FIN".

Les cartes, planches, tableaux, etc., peuvent être filmés à des taux de réduction différents. Lorsque le document est trop grand pour être reproduit en un seul cliché, il est filmé à partir de l'angle supérieur gauche, de gauche à droite, et de haut en bas, en prenant le nombre d'images nécessaire. Les diagrammes suivants illustrent la méthode.

ils  
lu  
diffier  
ne  
age

rata  
o

relure,  
à

IN

BEING

A  
~~3008~~  
D15

THE  
INDEX OF CURRENT EVENTS

---

---

1889.

---

---

BEING AN INDEX TO THE DATES OF THE PRINCIPAL EVENTS THROUGHOUT THE  
WORLD WHICH HAVE ATTRACTED PUBLIC ATTENTION  
DURING THE YEAR.



EDITED AND PUBLISHED BY HENRY DALBY.

MONTREAL, CANADA.

—  
MDCCLXXXIX.

C. 100

IN

VOL.

Com  
the act  
public  
The  
file for  
each m  
The  
to date.  
We be  
papers o  
cipally f  
poraries  
luxury o  
The  
in adva

Entered according to the Act of the Parliament of Canada, in the year one thousand eight hundred and eighty-nine,  
at the office of the Minister of Agriculture, at Ottawa, by Henry Dalby.

F  
D 11  
1003

Mr. J  
I am sen  
will be m  
cular pain  
public me  
you will d  
librarians  
Mr. J  
and six D  
Current E  
I rega  
such succe  
year.  
Mr. H  
heartily by  
enterprise  
year hono  
Judgment  
in all subs  
Sir Ch  
" It seems  
reference  
Mr. B  
writes :- "  
a desiderat  
Mr. C  
congratula  
its execut  
Mr. V  
the Indices  
dates of in

Abyssinia,  
Cos  
Abyssinia,  
sac  
Jan  
Abyssinia,  
Jan.  
Abyssinia,  
Fre  
ACCIDENT  
kille  
Aeronn  
driv  
Collisi  
Bain  
lide.  
Drown  
a La

# THE INDEX OF CURRENT EVENTS.

VOL. II. No. 4.

MONTREAL, FEBRUARY 7, 1889.

\$6.00 PER ANNUM.  
PUBLISHED WEEKLY.

Commencing with Vol. II No. I the dates given in the *Index* are the actual dates of the occurrences, not as hitherto the dates of publication.

The *Index* is published four times a month; but to form a complete file for the year it is necessary to preserve only the first issue in each month.

The intermediate issues contain the news of the current month to date.

We have to acknowledge with thanks the receipt of a large number of papers offered in exchange for the *Index*. As the *Index* is published principally for the use of editors, and has to depend chiefly upon its contemporaries for support, it is obviously impossible for it to indulge in the luxury of an exchange list.

The subscription is \$6 per annum, payable yearly or half yearly in advance. Remittances should be made to

HENRY DALBY,  
P. O. Box 864,

MONTREAL, Que.

MR. MARTIN J. GRIFFIN, LIBRARIAN OF PARLIAMENT, Ottawa, writes: "I am sending you a subscription for two copies of your '*Index*,' which will be most useful and which deserves encouragement. If you will take particular pains to give the dates and figures of elections and the dates of speeches of public men, with references also to the place at which the speech was delivered, you will do a very grateful thing for public people and editors, and I may add librarians."

MR. JOHN M. DOANE, STATE LIBRARIAN OF OHIO, writes:—"Enclosed please find six Dollars, in payment for State Library subscription to the '*Index of Current Events*;' for 1889."

I regard it as a very valuable publication, and hope that you may meet with such success as to warrant its continuance, for it will grow more valuable every year.

MR. HERRICK, OF THE BROOKLYN *Eagle*, writes:—"I congratulate you most heartily upon having done a good thing, a very good thing, in starting the '*Index*;' enterprise. I hope I may have the joy of congratulating you upon your success year hence. A man with *Index* on the brain is one after my own heart. My judgment was formed upon Number I; if the indexing is kept up as thoroughly in all subsequent numbers it will be a great help to us."

SIR CHARLES TUPPER, BART., HIGH COMMISSIONER FOR CANADA, writes:—"It seems to me to be a very useful publication, and one that will be valuable for reference purposes."

MR. BURN, ASSOCIATE EDITOR OF THE PHILADELPHIA *Public Ledger*, writes:—"Your *Index* is highly appreciated at this office, where it has long been a desideratum."

MR. COLQUHOUN OF THE "TORONTO EMPIRE," writes:—"Allow me to congratulate you most cordially upon your admirable *Index*. The idea and its execution are alike worthy of all praise."

MR. VALEN, OF THE "NEW-YORK MORNING JOURNAL," writes:—"I find the *Index* of great value, saving, as they do, much valuable time in looking up dates of important events."

(FROM THE MONTREAL GAZETTE).

Mr. Henry Dalby, a well-known and respected journalist of this city, has been for some months past publishing a periodical which all persons, whose business demands accuracy of date, all students of contemporary history, all newspaper writers, and, in fact, all persons who would have within their reach an unfailing *aide-memoire* as to the chronology of their own time, will find extremely useful. It is entitled "*The Index of Current Events*," and is published weekly. Though necessarily brief, the record of each successive noteworthy event is sufficiently clear to be an mistake as to its purport. Where fuller information is sought, the date supplies prompt indication of hundreds of authorities on the subject, as the reader has only to turn up the file of his local newspaper to bring all the particulars back to his mind. No memory however active and extensive could keep track of the rapid succession of occurrences of every nature and kind which, in this telegraphic age, form the raw material of history. But by this ingenious plan the searcher is never astray. Instead of perplexing himself and boring his friends, he consults his *Index*, and there, if a politician, he finds the election of which he desired the date; if a business man, the failure, or the rise in wheat or the promulgation of the new tariff; if an insurance agent, he is at no loss as to the fire in which he is interested; if a sportsman, he can learn when the great race comes off. In fine, such a chronological record is invaluable to some and serviceable to all. The subscription is \$6, payable yearly or half-yearly, in advance. Address, 31 University street, Montreal.

(FROM THE ALBANY SUNDAY PRESS.)

The *Index of Current Events*, a weekly publication by Henry Dalby, 31 University street, Montreal, is an eminently valuable enterprise. It thoroughly reviews recent events, and is a great help to historically inclined readers.

(FROM THE TORONTO EMPIRE.)

The memory of the average individual is seldom able to recall with accuracy information regarding recent events. It is surprising how vague the ideas of people are as to the exact date when events happened within the preceding year or half year. Professional men often need just such knowledge, and are frequently at a loss without it unless a good deal of time be spent in "hunting up" the facts required. Mr. Henry Dalby, a well-known Montreal journalist, is issuing an *Index of Current Events* to obviate this difficulty. The *Index* is a complete compendium, issued weekly, of the occurrences recorded from every part of the world in the columns of the newspapers. Each entry is brief, but the gist of the matter is there, and fuller details can be obtained by turning to a newspaper file, an easy performance when one knows the exact date. The *Index* will be simply invaluable in a newspaper office, while many others besides journalists will consider it a great convenience.

(FROM THE PORTLAND ADVERTISER.)

A unique magazine comes from Montreal—*The Index of Current Events*. It is a classified index to the dates of publication of important occurrences reported in the newspapers. It is published every week, for convenience, but the notices in every month contain all the references for the preceding month, and alone needs to be preserved to form a complete file. The *Index* will be very useful to everybody who has occasion to conduct the files of newspapers. The Price is \$6 a year.

## JANUARY.

Abyssinia, Austrian steamer "Aniphithrite" arrives at Suakim with 100 Cossacks to found colony.—Jan. 14.

Abyssinia, Obock Military expedition under command of notorious Cossack raider Aschinoff refused by authorities permission to land.—Jan. 16.

Abyssinia, King John making preparations for war with King of Shoa.—Jan. 23.

Abyssinia, Aschinoff's expedition of Cossacks lands at Tadyghwih in French Territory.—Jan. 24.

ACCIDENTS.—Explosions, Spain, Otter Colliery in Asturias, 27 persons killed.—Jan. 3.

Aeronauts, Antwerp, Wolff Henri and Lieut Daniel ascend, balloon driven out to sea.—Jan. 16.

Collieries, Green Island, N.Y., car on Troy and Lansing's 4th street Railroad and passenger train on Delaware and Hudson railroad collide.—Jan. 25.

Drowning, Kingston, Ont., 16 men and 18 teams of horses drowned in a Lake in the backwoods.—Jan. 28.

## ACCIDENTS.—Continued.

Duluth, Minn., walls of burned Opera house fall, burning a number of people in the ruins.—Jan. 29.

Explosion, Brooklyn, two gas tanks of Citizens' Gas Company explode.—Jan. 10.

Explosions, Crewe, Eng., laden of molten steel collapses, twenty men injured.—Jan. 25.

Explosion, Manchester, Eng., Hyde Colliery, 100 persons entombed.—Jan. 18.

Fires, Brooklyn, Mo., house of Mrs. Minnie Hall, five inhabitants burned to death.—Jan. 19.

Fires, Duluth, Minn., Grand Opera House and Post office.—Jan. 28.

Fires, Eganville, Ont., Mrs. Bonfield's grist mill.—Jan. 20.

Fires, Fergus, Ont., James Wilson's oatmeal mill.—Jan. 18.

Fires, Germany, Prince Bismarck's residence, building near his famous boat round Reichshaus burned to death.—Jan. 20.

Fires, Liverpool, Eng., Cotton warehouse on docks, loss \$250,000.—Jan. 18.

Fires, London, Eng., mansion of Hon. Percy Selwyn Wyndham.—Jan. 7.



ACCIDENTS.—Continued.

Fires, London, Ont., one of the large cottages at the Asylum.—Jan. 27  
 Fires, Manchester, Conn., entire business portion of town.—Jan. 4.  
 Fire, New York, Patent Cigar Box Manufacturing Company, three girls burned to death.—Jan. 15.  
 Fires, Paris, the Schobastie buildings destroyed.—Jan. 10.  
 Fires, Pernambuco, steamer "Stephen D. Hooper," from Calcutta for New York, burned at sea.—Jan. 3.  
 Fire, Reading, Pa., paint shop of Reading Railway Co., five men burned to death.—Jan. 9.  
 Fire, St. Louis, building of Richardson Drug Company, loss \$900,000.—Jan. 2.  
 Fires, St. Louis, Olympic theatre, panic.—Jan. 26.  
 Fires, St. Paul, Minn., Grand Opera House destroyed.—Jan. 21.  
 Fires, Bamou, German consulate destroyed.—Jan. 20.  
 Fires, Welland, Ont., Salvation Army Barracks destroyed.—Jan. 21.  
 Freezing, Tiflis, Georgia, train blocked in snowdrift at Tabuoteche fourteen passengers perish.—Jan. 4.  
 Ice New Haven, Conn., nine persons rescued by Fred. Morris, aged eighteen.—Jan. 18.  
 Machinery, Buffalo, N. Y., Iron Works, John Strow killed by bursting of an Emery wheel.—Jan. 25.  
 Mining, Mining Inspector of United States, report for 1888.—Jan. 4.  
 Railway, Brooklyn, accident on King's County elevated railroad, one man killed and others injured.—Jan. 24.  
 Railway, Fitchburg, Mass., twenty-four freight cars wrecked.—Jan. 23.  
 Railway, M'apah, N. C., train wrecked, fireman Adams and others killed.—Jan. 27.  
 Railway, Montreal, Grand Trunk Railway, an engine collides with Delaware and Hudson train, Miss Henrietta Boissonault of Grande Ligue killed.—Jan. 22.  
 Railway, New York, Ninth Avenue train runs into Sixth Avenue train, several persons injured.—Jan. 24.  
 Railway, Pl Creek Bridge, Texas, Southern Pacific Railway freight train runs into a passenger train.—Jan. 28.  
 Railway, Rockport and Cannelton accommodation train thrown from track between Lincoln city and Chrisney, Md., 36 persons injured.—Jan. 28.  
 Railway, Spottsville, Ky., on Louisville, St. Louis and Texas Railroad a bridge gives way, twelve men killed.—Jan. 20.  
 Railway, Tallmage, Ohio, passenger train on New York, Pennsylvania and Ohio Railroad runs into freight train, both engines, both firemen and eight passengers killed.—Jan. 14.  
 Railway, Waterment, Mich., on Menominee Branch of Chicago and North Western Railway, car thrown off track, Lieut. Gov. of Michigan, and others, killed.—Jan. 21.  
 Railway, Wales, Rhonda railway, 7 persons killed by fall of rock in a tunnel at Abergyrull.—Jan. 23.  
 Storm, Reading, Pa., about 125 lives sacrificed.—Jan. 9.  
 Storm, Pittsburg, Pa., buildings blown down, many persons killed and injured.—Jan. 9.  
 Sunbury, Penn., wind blows over nail mill, burying 18 men.—Jan. 10.  
 Suffocation, Saxony, family by name of Rindolf suffocated by gas from defective stove at Crussen.—Jan. 25.  
 Afghaniatan, Ameer fired at by Sepoy of the Herat Infantry, who is executed on the spot.—Dec. 24.

AFRICA EAST.—Continued.

AFRICA EAST.—Dares Salaam, all British traders see from, situation daily growing worse.—Jan. 3.  
 Ashe Rev. Mr., recently from Bagamoyo interviewed at London, Eng. he attributes trouble to German aggression.—Jan. 13.  
 and Germany, Prince Bismarck in declining disparages reports concerning British Niger Company.—Jan. 15.  
 Bill "for protecting German interests and combatting the slave trade," submitted in Prussian Bundersrath.—Jan. 15.  
 Prussian Bundersrath approves bill.—Jan. 23.  
 English Missionary named Brooks and 16 of his followers massacred.—Jan. 19.  
 Bagamoyo, further fighting at, Arabs jubilant over recent victories.—Jan. 19.  
 Zanzibar, disasters to the squadron, fever raging among the crews.—Jan. 7.  
 Zanzibar, Downer Captain, commander of German flagship "Aljeisig," dies of fever.—Jan. 10.  
 Lindt, natives of, Apologies for firing on boat belonging to English Man-of-War.—Jan. 11.  
 Zanzibar, hundred of slaves liberated on New Year's Day.—Jan. 1.  
 Zanzibar, Governor of Mozambique defeats Bonga and returns home.—Jan. 11.  
 Zanzibar, Insurgent tribes of coast attack German mission at Daries, Saluam.—Jan. 12.

AFRICA EAST.—Continued.

Zanzibar, Sultan offers to mediate between East Africa Company and natives on plan suggested by Company's Agent General.—Jan. 14.  
 Zanzibar, Arabs kill eight missionaries and mutilate their bodies, and carry off servants and released slaves.—Jan. 17.  
 Zanzibar, Sir John Kirk starts from London for, on special mission, to endeavour to effect settlement of difficulties.—Jan. 19.  
 Zanzibar, Captain Wessauu appoints German consul at.—Jan. 21.  
 Sulymah, conflict between native policemen and a party of warboys, 131 of the latter slain.—Jan. 23.  
 Letter from Togoland states that slave traders are turning their route to the Togo coast.—Jan. 24.  
 Dar-Es-Salem, engagement takes place resulting in defeat of the Arabs.—Jan. 25.  
 Bill brought up in German Reichstag, speech of Prince Bismarck.—Jan. 26.  
 Zanzibar, pecuniary embarrassment of, in consequence of German East Africa Company.—Jan. 26.  
 Zanzibar, report from German Consul as to rising at Dar-Es-Salem and as to sickness of troops.—Jan. 26.  
 King of Belgium creates an African Society of the Red Cross.—Jan. 28.  
 Bill passes second reading in German Reichstag.—Jan. 29.  
 Month, Earl Gray issues long manifesto on British policy in.—Jan. 29.  
 Alaska, great hardships experienced by traders and hunters owing to severe winter.—Jan. 31.  
 Alexander Prof. William J., appointed by Ontario Government to professorship of English language and literature in Toronto University.—Jan. 29.  
 Albat Madam, a rival of, in New York.—Jan. 21.  
 Albat Madam, Montreal, arrival at, and interview with.—Jan. 21.  
 Allumettes Inland, Que. Michael Cullen, farmer, drops dead and is eaten by his hog.—Jan. 17.  
 American public school system, Cardinal Manning's paper upon.—Jan. 8.  
 America and Germany, Zanzibar, American sailing vessel fired on by German vessel.—Jan. 25.  
 American Peace Society at Boston, adopts resolutions of congratulation to United States, Canada and Great Britain.—Jan. 28.  
 Anarchism, Chicago, Hronek sentenced to twelve years in Penitentiary.—Jan. 2.  
 Anarchism, Brussels, Gilliet sentenced for crying "down with the Austrian" when the Queen passed.—Jan. 22.  
 Anarchism, Chicago, address by Gott Gratkan.—Jan. 20.  
 Anarchism, Chicago, Mrs. Par sons makes her second speech.—Jan. 23.  
 Annon King of, death of.—Jan. 29.  
 Annon, Grand Council elects Bunfay as King.—Jan. 31.  
 Annexation, Canadian, resolution passed by county council at York, Ont.—Jan. 30.  
 Annexation of Canada, Chicago, Mr. I. I. Moore, merchant of Toronto, interviewed at.—Jan. 24.  
 Annexation, Mr. Blair in United States Senate argues as to how it would benefit the French Canadian people.—Jan. 11.  
 Annexation, McCall, Liberal M.P.P. for Pictou, N.S., publishes an address favouring himself in favor of.—Jan. 12.  
 Annexation, Canadian, Hon. Mr. Laurier sends circular to member of liberal party.—Jan. 17.  
 Annexation, Wiman Mr., addresses the Lincoln Club, Brooklyn, New York.—Jan. 12.  
 Annexation, Windsor, Ont., Twomey Mr., newly elected mayor, inter viewed thereon.—Jan. 14.  
 Anti-Semitic Association, annual fete of students of Berlin, Germany.—Jan. 22.  
 Archeology, American school of, resumes its session at Athens.—Jan. 3.  
 Art, British, London, Eng., important exhibition in Grosvenor Gallery.—Jan. 19.  
 Artists, London, Stutt, Parisian artist, denounces Whittier at the Huganith Club as a liar and a coward.—Jan. 2.  
 Asbestos, Bell's Company, first meeting of, at London, Eng.—Jan. 31.  
 Astronomical, Nice, Asteroid discovered.—Jan. 30.  
 Attica, N. Y., Althouse Mrs. Emma, in a swoon for twenty-nine days.—Jan. 31.

AUSTRIA.—Army bill, Herr Von Lissa, prime minister, threatens to resign unless a bill passed by Reichsrath.—Jan. 10.  
 Danube River froze solidly distance of 18 miles below Vienna.—Jan. 15.  
 Death of Archduke Rudolf, Crown prince.—Jan. 30.  
 Death of Crown prince, details as to.—Jan. 30.  
 Archduke, Charles Louis Emperor's brother officially announced as heir to the throne.—Jan. 31.  
 Prince Rudolf's suicide, evidence of Prof. Wiederhofer, who performed the autopsy.—Jan. 31.

AUSTRIA—Continued.

King of *Armenia* an African Society of the Red Cross.—Jan. 28.  
 Deputation from Russian regiment arrives at Vienna to congratulate their honorary colonel the Emperor Francis Joseph.—Jan. 9.  
 Halsefeld, Socialist Congress at.—Jan. 2.  
 Vienna, Socialist leader Becker and 27 others arrested.—Jan. 14.  
 Vienna, banquet given by Emperor in honor of Prince Alexander of Battenberg.—Jan. 19.  
 Balfour Mr., number of policemen detailed to protect him increased.—Jan. 9.  
 Bank, Maritime Bank, St. John, N. B., liquidators pay second dividend to note holders of thirty cents on the dollar.—Jan. 22.  
 Banks, Ville Marie Bank, Hull, Ont., robbed of \$6,000.—Jan. 15.  
 Bazaar, church at Hamilton, lottery at, declared to be gambling.—Jan. 2.  
 Behring sea, fishing in, United States Senate, Senator Howe moves for papers on the subject.—Jan. 2.  
 Behring Sea, seal fisheries, Mrs. Dingley presents resolution upon, in United States House.—Jan. 21.  
 Belgium, Anne-hat named Gillett sentenced at Brussels for crying "down with the Austrians" when the Queen was passing.—Jan. 22.  
 Bell's Asbestos Company, first meeting of at London, Eng.—Jan. 31.  
 Bi-metallic league, Duke of Richmond and Gordon accepts presidency of.—Jan. 21.  
 Bismarck's attempt to control the *St. James Gazette* London statement of Mr. Greenwood, late principal editor.—Jan. 18.  
 Bismarck Dynasty, article appears in contemporary review, consisting of bitter attack on Bismarck and his son.—Jan. 30.  
 Black Sea, severe weather, many wrecks, over 100 seamen lose their lives.—Jan. 8.  
 Blaine Walter, breaks his leg at Washington.—Jan. 11.  
 Blaine Mr., *Secretary*, Washington, avows states he has accepted position of *Secretary* of State in Gen. Harrison's cabinet.—Jan. 28.  
 Bosnia, Belviders, N. J., Huntman M. N., sentenced for.—Jan. 18.  
 Bosnia, Austria, by agreement with Porte to occupy second portion of the Sandjick of Novi Bazaar.—Jan. 14.  
 Brazil, Middleton Mr. A., who has been examining the Araguay river, interviewed at Ottawa.—Jan. 9.  
 Breach of promise, Millbrook, Ont., Mrs. Reynolds, widow, sues Mr. Jamieson 70 year old widower, for \$30,000.—Jan. 17.  
 Bright Rt. Hon. John, M.P., release of.—Jan. 17.  
 British Columbia Legislature opening.—Jan. 21.  
 British extradition treaty ordered by United States Senate to be discussed in Executive session.—Jan. 22.  
 Bucket shops, Toronto, denounced by Judge Rose in opening Assize Court.—Jan. 22.  
 Burial refused in a Catholic cemetery, New York, Phillip McGuire against trustees of St. Patrick's cemetery decided at New York by Judge Beach.—Jan. 8.  
 Burma British troops engage rebels at Livokow, latter defeated, with 150 killed.—Jan. 8.  
 Canada Parliament, opening of, by Governor General.—Jan. 31.  
 Canada Pulverizing Company, letters patent issued incorporating.—Jan. 23.  
 Canada Temperance Act, petitions from Counties of Frontenac, Peterboro Colchester, Brant, Wellington, Kent, and city of St. Thomas for repeal of, passed at Council at Ottawa.—Jan. 21.  
 Canadian trade with West Indies and British Guiana, Sir John McDonald gives address on, before Toronto Board of Trade.—Jan. 18.  
 Canadian Franchises club organized at Toronto.—Jan. 3.  
 Canadians honour, New Year's list of.—Jan. 3.  
 Canadian Inland Marine Association finishes its annual meeting at Toronto.—Jan. 10.  
 Canadian Society of Civil Engineers, annual meeting of.—Jan. 17.  
 Cannibalism, H. y. y. horrible story told by correspondent of New York  *Herald*.—Jan. 15.  
 Carbondale, Pa., Italians and Hungarians working on north-west breaker have terrific fight.—Jan. 13.  
 Carnegie Andrew, offered Interior Secretaryship by General Harrison.—Jan. 19.  
 Carriage, Illa., wolf hunt participated in by 600 men and boys.—Jan. 23.  
 Catholic Colonization Society formed at Pittsburg, Pa., to establish colonies in the South.—Jan. 23.  
 Cattle, English Agricultural journals appeal to Government to cease present exemption to Canada.—Jan. 5.  
 Cecil Captain, Lord William, resigns from the British Grenadier Guards.—Jan. 17.  
 Century Club of London, Eng., gives dinner to Mr. Phelps, U. S. minister.—Jan. 29.  
 Chamberlain R. g. t. Hon. Jos. and bride welcomed at Birmingham, Eng.—Jan. 8.  
 Chamberlain Mr. Joseph, speaks on Home Rule at Birmingham.—Jan. 9.  
 Chamberlain Jos. M. P., addresses meeting at Birmingham.—Jan. 23.

Chartreuse, London firm offers General of the Carthusian Monks £3,000,000, for monopoly of manufacture and sale.—Jan. 17.  
 Chicago Board of Trade protests against introduction in legislatures of Pennsylvania, Ohio, Kansas and Colorado of bills excluding dressed beef, pork and mutton for sale in those States.—Jan. 24.  
 Chicago police charged with receiving stolen property from prisoners and thieves.—Jan. 4.  
 Chicago, charges against police, warrants for criminal libel sworn out against J. J. West, proprietor, and Joseph Dunlap, city editor of "*The Times*".—Jan. 4.  
 Child labor, Mrs. Amelia Rives Chandler offers prize of \$100 for best American essay on.—Jan. 24.  
 CHINA.—American and German Ministers submit proposal to Chinese Government for concession for constructing railways.—Jan. 5.  
 Famine and drought prevailing in the interior.—Jan. 5.  
 Retaliation against United States, Mr. L. Mougkwa, manager of King Tye company, interviewed at Ottawa thereon.—Jan. 8.  
 China, Emperor, of arrangement of household for, to consist of 600 persons.—Jan. 17.  
 Shanghai, Imperial decree issued prohibiting further extension of Tientsin Railway.—Jan. 29.  
 Cholera, Malabar coast, violent epidemic at Quilon.—Jan. 2.  
 Civil Service examinations Canadian, result of examinations.—Jan. 12.  
 Coal, Buisseau, also, vein of coal discovered at.—Jan. 16.  
 Coal exports, Nova Scotia, for year 1888.—Jan. 11.  
 Coal, Centerville, Dak., valuable deposit discovered at.—Jan. 7.  
 Coal mining, Shenandoah Region, Park Place, Centralia, and all the Lehigh and industrial collieries shut down.—Jan. 28.  
 Combines, Naise, Hungary, collapse of.—Jan. 4.  
 Combines, silk firms, London and Lyons.—Jan. 4.  
 Comet discovered by Prof. Brooks at Smith Observatory, Geneva.—Jan. 15.  
 Commercial Union denounced at Petersburg, Ont., by Dalton McCarthy, M. P., and Col. DeLion.—Jan. 12.  
 Companies, Joint Stock, London, total capital of, registered during past year.—Jan. 4.  
 Congo Uganda, King Newanga overthrown and expelled, his elder brother Kimwa enthroned in his place, English and French missions destroyed and converts massacred.—Jan. 11.  
 Connemara Lady, wife of Governor of Madras presidency, refuses to live in Government House with her husband.—Jan. 2.  
 Cook Islands, Annexation of, by Great Britain, discussed in French Chamber of Deputies.—Jan. 21.  
 Copper, European Syndicate refuses to buy any more copper.—Jan. 29.  
 Copyrights, decision by Judge North of London, Eng., as to copyright in a newspaper paragraph.—Jan. 28.  
 Copyright, Canadian, Deputation from Canadian Copyright Association waits upon Ministers at Ottawa and explains their grievances.—Jan. 22.  
 Copyright, International Association, annual meeting at Boston.—Jan. 2.  
 Corea, Judge Kenny, American adviser of King of Corea, denies statement that Russian protectorate arranged.—Jan. 5.  
 Cornwall, Ont., Weavers brought from Boston by agent for Canada Cotton Company solicit assistance to return home again.—Jan. 24.  
 Cosack Colonists, insurrections issued by Admiral Brants, Minister of French Marine, to Governor of Obock, relative to.—Jan. 26.  
 Costa Rica, earthquakes in different parts, great destruction of life and property.—Dec. 30.  
 Cottons, Canadian made, Toronto, advance of 20 per cent. made on.—Jan. 21.  
 Counties, Council for united counties of Stormont, Dundas, and Glengarry session opens at Cornwall, Ont.—Jan. 23.  
 Counties Council of Stormont, Dundas and Glengarry in session at Cornwall pass resolution in favor of prohibition.—Jan. 28.  
 Crete, Rifolisa, Zami Siamatikes, his daughter and son-in-law murdered by Brothers Katsolaka.—Jan. 22.  
 CRIMES.—Abortion, Toronto, Lily Charlton's inquest.—Jan. 3.  
 Abortion, Toronto, Lily Charlton, no bills found against Dr. Valentine and Ally Wilkinson, and true bill against druggist J. O. Wood.—Jan. 25.  
 Absconders, Bologna, cashier of National Bank Agency at.—Jan. 26.  
 Absconders, Olevland, Ohio, Crobaugh H. G.—Jan. 7.  
 Absconders, Chicago, Horner Lewis, of Horner & Co.'s grocery establishment, arrested at Montreal.—Jan. 2.  
 Absconders, Chicago, Vines Thomas, of Adams Westlake Manufacturing Co., captured in a trunk at St. Louis.—Jan. 2.  
 Absconders, Sarnia, Ont., Bickhart Fred. L., of Oscoda, Mich., arrested at.—Jan. 19.  
 Absconders, Toronto, Barnett R. G. I., true bill returned against.—Jan. 23.  
 Absconders, Troy, N. Y., Austin Charles, bookkeeper for Bussey and McLeod, stove foundry men.—Jan. 18.  
 Assault, Indianapolis, Hacker George, Anarchist, sentenced to 14 years penitentiary for assault on his employer James Bruce.—Jan. 18.

## CRIMES.—Continued.

Boodling, New York, second trial of ex-Ald Clergy commences.—Jan. 21.

Burgamy, Whitby, Ont., Martin W. I., of Prescott, arrest of.—Jan. 16.

Burglars board Boston & Lowell at Vermont Central Railroad train at Sixbridge Station, conductor Church's account.—Jan. 3.

Burglary, Bournemouth, Eng., burglars enter house where Count Kelolye, Austrian ambassador, adjoining, and steal £3,000 worth of jewellery.—Jan. 3.

Burglary, Cliftonville, attempt to enter railway station of Sangua Branch of Eastern Division of Boston and Maine Railway, watchman mortally wounded.—Jan. 24.

Burglary, England, Ramslade near Windsor, country house of secretary of American Legation, London, entered, and jewellery valued at \$35,000 stolen.—Jan. 31.

Cruelty, Brooklyn, N. Y., Malay seaman brutally treated by captain on "Sophia Joachim" from Calcutta.—Jan. 12.

Defaulter, Indianapolis, John A. Moore, insurance agent.—Jan. 26.

Defaulter, Indianapolis, Moore Joseph, a half million dollar embezzler, leaves for Canada.—Jan. 26.

Defaulter, New York, Fish James D., formerly president of Marine National Bank, president commutes sentence of.—Jan. 28.

Defaulter, New York, Ives Henry S. and Slayner George H., arrested at suit of Cincinnati, Hamilton and Dayton Railroad Company.—Jan. 26.

Defaulter, Pittsburgh, Pa., Yoight H. F., former cashier of Farmers and Mechanics Bank, arrested.—Jan. 17.

Defaulter, Richmond, Va., defalcation of \$100,000 discovered in accounts of City Collector who died recently.—Jan. 15.

Defaulter, Boston, Leighton, ex-clerk of Courts.—Jan. 3.

Defaulter, Brooklyn, N. Y., Andrea Hy., assistant business manager and advertising agent of the Brooklyn Zeitung.—Jan. 4.

Defaulter, Queen's county, New York, Lord Chas. Manning's confidential clerk and adviser of Sheriff's office.—Jan. 5.

Defaulter, Indianapolis, Moore Joseph A., correspondent of Connecticut Mutual Life Insurance Company of Hartford.—Jan. 24.

Defaulter, New York, Marshall Henry P., cashier of Seaman's bank, who died in November, discovered to be defaulter to extent of \$76,000.—Jan. 21.

Defaulter, Osceola, Mich., Bleckhart Fred. L., arrested at Sarnia.—Jan. 19.

Dynamite, Spain, Valencia, attempt to blow up palace of Archbishop.—Jan. 14.

Forger, Barton Thomas, of Macclesfield, Eng., arrested at Philadelphia.—Jan. 21.

Forgery, Chicago, several arrests for forging facsimiles of labels for Arduo's ink.—Jan. 24.

Forgery, Spain, man arrested at Madrid for forging Spanish Bonds to the amount of \$500,000.—Jan. 22.

Fraud, Electric Sugar Refining Company, President Cotterill returns to New York, from Ann Arbor, Mich., and can give no information as to Mr. Friend.—Jan. 11.

Frauds, New York, electric sugar refining company, cables sent to England to have warrants issued against Mrs. Friend and the Howards.—Jan. 8.

Frauds, New York, in the damage allowance, bureau at the appraisers stores in New York.—Jan. 26.

Incendiarism, Simcoe, Ont., Noves Ma. thew, sentenced to Penitentiary for life.—Jan. 2.

Robbery, Chicago, West side street railway plundered by conductors.—Jan. 23.

Robbery, Villa Marie Bank, attempt at New York to pass some of the notes.—Jan. 22.

Robbery, Eddy Guerin alias George Graham accused of stealing 500,000 francs from the Bank of France, at the request of French authorities is conveyed to Lyons from London, bound and closely guarded.—Jan. 25.

Suicides, Monto Carlo, young man and woman from Lyons kill themselves in hotel at.—Jan. 19.

Suicide, on steamship "City of Berlin," Queenstown to New York, Miss Gale takes rat poison and dies.—Jan. 19.

Suicide, Murray Bay, Quebec, Joseph Gray hangs himself while insane.—Jan. 21.

Suicide, Toronto, Michael Larkin, policeman, shoots himself.—Jan. 29.

Swindlers, Windsor, Ontario, Frank Aldrich charged with swindling S. K. Lemon of Pittsburg out of \$10,000, sentenced to gaol until extradition papers made out.—Jan. 20.

Swindling, Australia, Board of Queensland Investment Company in London orders arrest of four Australian directors.—Jan. 23.

Croke, Very Rev. Father James, death of, at New York.—Jan. 7.

Customs, Canadian flour millers meet at Palmer-ton, Ont., and pass resolution asking Minister of Customs to remedy discrimination against Canadian millers in favor of American.—Jan. 15.

Customs, Canada, rate reduced to \$2 per 1,000 feet if cut and ready for shipment at date of order increasing duty.—Jan. 21.

Customs, Canadian, instructions sent to collectors not to issue any more licenses to American fishing vessels under *modus vivendi*.—Jan. 26.

Customs, Canadian, five miles of railway between Calais and Pricetown, Me., on St. Croix and Penobscot seized.—Jan. 28.

Customs, Halifax, Hon. William Ross resigns office as collector of.—Jan. 22.

Customs, Puget Sound, Opium and Chinese seizure on British sloop "Emerald."—Jan. 12.

Customs, St. Jerome, P. Q., seizure of illicit tobacco in large quantities.—Jan. 15.

Customs, United States, Canadian Railway cars, orders sent to Detroit to detain Canadian cars on Grand Trunk and Michigan Central Companies, until duty paid thereon.—Jan. 15.

Customs, United States officer at Detroit stops George Yanackie, teacher of music, with valise, on ground that it was infringement of Foreign labor act.—Jan. 18.

Customs, U. S., Canadian cars, assistant secretary Maynard writes to collector of customs at Detroit.—Jan. 4.

Customs, United States, Canadian cars, collector Campeau's order suspended at Detroit, Me.—Jan. 22.

Customs, United States, Detroit (bustler turned back to Windsor, Ont., because he had his tools with him.—Jan. 26.

Customs, nursery products, proposal of representative Baker, of New York, to place a duty on nursery products imported from Canada to United States.—Jan. 5.

Dakota, Terr., St. Paul, Minn., *Pioneer Press* publishes figures showing State is bankrupt.—Jan. 22.

Danish Government addresses protest to United States as Greenland fisheries.—Jan. 1.

Davis Jeff, Jones James H., of Raleigh, N. C., former slave, writes to his old master.—Jan. 2.

Defence of Great Britain, deputation urges comprehensive scheme upon Lord Salisbury.—Jan. 4.

DEATHS.—Croke Very Rev. Father James, at New York.—Jan. 7.

Archduke Rudolf, Austrian Crown Prince.—Jan. 30.

Beecher Henry, Q. C., ex-Mayor, London, Ont.—Jan. 17.

Belcher Rev. Canon, of Montreal.—Jan. 23.

Cartier M., leader of Swiss radicals.—Jan. 29.

Deut Col. John C., brother-in-law of General Grant, death of, at Carthage, Mo.—Jan. 2.

Delaro Madame Selina, singer, and author of a number of plays at New York.—Jan. 23.

Downer Captain, commander of German flagship "Liepzig" at Zanzibar.—Jan. 10.

Di Murska Madame, famous singer, at Munich.—Jan. 17.

Edgarty Mrs. Nancy, aged 104 years, at Woltboro, N. H.—Jan. 26.

Felton Samuel M., president of Pennsylvania Steel Company at Philadelphia, Pa.—Jan. 4.

Gavezzi Father, Italian patriot, at Rome.—Jan. 14.

Gebau Mr., Author.—Jan. 21.

Gould Mrs. Jay, at New York.—Jan. 13.

Hughes Right Rev. Joshua, Bishop of St. Asaph.—Jan. 22.

Hueffer, Francis, Ph.D., English musical critic and writer.—Jan. 21.

Holmes Richard, aged 102, dies at Farmersville, Ont.—Jan. 25.

King of Annam.—Jan. 29.

Lathern, Dr. J. S., at Halifax, N. S.—Jan. 27.

Legare Mr. Louis, C. E., superintendent of Montreal Water Works death of.—Jan. 9.

MacDonnell A. G., superintendent of Williamsburg canal, death of, at Morrisburg, Ont.—Jan. 27.

McMillan Rev. Duncan, Presbyterian minister, at London, Ont.—Jan. 26.

McGregor Mr. Donald, of Martintown, Glengarry, death of.—Jan. 2.

Macdonald A. P., Dominion contractor at Toronto.—Jan. 23.

Mason Camilla Teresa, of Toronto, who eloped with James Anderson, dies at St. Paul, Minn., in poverty.—Jan. 9.

Mezies Robert Stewart, M. P. for East Perthshire.—Jan. 25.

Lieut. Miles of United States steamer "Zantic" from Bayti dies of yellow fever at New York.—Jan. 14.

Montague Col. George, formerly of Black Watch Highlanders, at Halifax, N. S.—Jan. 11.

Paxton Andrew, agent of Chicago Citizens League, at Chicago.—Jan. 15.

Pellegrine, the caricaturist, known as "Ape," in London, Eng.—Jan. 22.

Phillips George, journalist of New York, death of, at Morrystown, N. Y.—Jan. 13.

Phillips James O. H., Shakesperian biographer.—Jan. 4.

Quezada, Spanish General.—Jan. 21.

Reed George W., editor and stockholder of *Brooklyn Eagle* at New Brunswick, N. J.—Jan. 18.

Roberts William Lorman, Baltimore, stock broker and society man.—Jan. 4.

DEATHS  
Ric  
She  
Vor  
Deok  
Dipthe  
Dipthe  
Dipthe  
Dr Murs  
Diplom  
DIPLO  
Gre  
Hun  
Uai  
Unib  
Unib  
Unib  
Divorce  
Ja  
Divorce  
Div  
Dominion  
Dominion  
Duel, Cin  
De  
Duel, Fran  
Duel, Fran  
Duel, Fran  
Duel, Fran  
Dufferin  
Dynamite  
Dynamite  
Dynamite  
Earthquake  
22  
Earthquake  
Earthquake  
Earthquake  
East Africa  
Easter Isl  
ECCLESIA  
Pap  
Chicago  
Hil  
Educa  
Irish  
Ireland  
Leeds  
Bapt  
London  
the  
Londo  
-Ja  
Ningar  
from  
Jau.

## DEATHS.—Continued.

Richards Sir William Buell, ex-Chief-Justice of Supreme Court of Canada, at Ottawa.—Jan. 26.  
 Shepard C. A. B., of firm of Lee & Shepard, book publishers, Boston, death of.—Jan. 25.  
 Von Munn, Admiral Count, minister of Imperial German Navy, at Berlin.—Jan. 22.  
 Decker, Md., small lake, burning at.—Jan. 21.  
 Diphtheria, Point Rouge, in Port-au-Pin, forty fatal cases in.—Jan. 22.  
 Diphtheria, Selkirk, Man., outbreak of.—Jan. 18.  
 Diphtheria, Hungary, epidemic at Nagó.—Jan. 11.  
 Di Murska Madame, singer, death of, at Munich.—Jan. 17.  
 Diplomatic and Consular bill debated in United States House of Representatives, speech by Mr. McAdoo of New Jersey.—Jan. 12.

DIPLOMATIC, England and Italy, Dufferin Lord, presents his credentials to king of Italy.—Jan. 9.

Great Britain and United States, report that former will appoint successor to Lord Mackenzie after inauguration of President Harrison confirmed.—Jan. 12.

Hungary and United States, consul at Buda-Pesth, recalled by United States Government.—Jan. 30.

United States, amendment in United States Senate to Diplomatic bill, raising ministers to rank of ambassadors, rejected.—Jan. 31.

United States, Senator Gibson moves in Senate to amend diplomatic bill, by creating ministers at France, Germany, Great Britain and Russia Ambassadors.—Jan. 28.

United States Senate agrees to Mr. Gibson's amendment to Diplomatic and Consular bill making the title of ministers of France, Germany, Great Britain and Russia Ambassadors.—Jan. 29.

Divorce, Gladstone Mr., writes article on, in *Nineteenth Century*.—Jan. 31.

Divorce, England, Mrs. Dion Boucault, *vs* Agnes Robertson, granted divorce.—Jan. 16.

Dominion Alliance, Montreal, annual meeting of Quebec Provincial branch.—Jan. 15.

Dominion Alliance, meeting of Ontario Branch at Toronto, the Montreal platform adopted.—Jan. 23.

Duel, Cincinnati, Ohio, on stage of Standard Theatre, between "Running Deer," an Indian chief, and Capt. Jack Crawford, the scout.—Jan. 22.

Duel, France, between Comudet, Member of Chamber of Deputies, and Chabrouillard, editor, fought at Paris.—Jan. 21.

Duel, France, Floquet M., president of Council of Ministers, challenged by M. Lawe, member of chamber of deputies.—Jan. 15.

Duel, France, fought at Paris between Henry Rochefort, editor of *Univers*, and M. Liessagary, editor of *La Bataille*.—Jan. 14.

Dufferin Lord, arrives at Rome, and received by King Humbert.—Jan. 7.

Dynamite, Hungary, Kesseniza, 23 cans stolen from.—Jan. 7.

Dynamite outrage, Mahoney Plane, Pa., bomb explodes on Pennsylvania and Reading Railroad.—Jan. 4.

Dynamite gun, trial of Zoluska's gun at Fort Lafayette.—Jan. 19.

Earthquake, Greece, shocks felt at Athens, Megara and Arachova.—Jan. 22.

Earthquake, Leith Valley and Western Edinburgh, Scotland, shock felt in.—Jan. 18.

Earthquake, Smyrna, 300 houses in Sarabal Valley destroyed by.—Jan. 22.

Earthquake, San Jose de Costa Rica, severe shocks, several persons killed, much damage to property.—Jan. 3.

Earthquake, St. Denis, Kamouraska, smart shock at.—Jan. 29.

East African bill approved by committee of German Reichstag, save the clause for placing East Africa Company under control of Captain Wissmann.—Jan. 28.

Easter Island, session to Chili discussed in French Chamber of Deputies.—Jan. 21.

ECCLÉSIASTICAL, Ireland, Archbishop Walsh reads message from the Pope.—Jan. 2.

Chicago, excitement over Father Dowd's denunciation in Montreal of Illinois Catholic order of Foresters.—Jan. 20.

Education of German Catholics in America, Cardinal Melchers directed by the Pope to prepare report on the relation of complaint of Irish Bishop in America.—Jan. 12.

Ireland letter from Pope read in churches of Down and Connor sympathizing with Irish people.—Jan. 6.

Leeds, Eng., Baptist conference agrees upon Union with particular Baptists.—Jan. 16.

London, England, Rev. Mr. Macquill succeeds Dr. Oswald Dykes at the Regent Square Presbyterian church.—Jan. 10.

London, Ont., death of Rev. Duncan McMillan, Presbyterian minister.—Jan. 26.

Niagara, Anglican diocese of, Ritualistic movement in, leads to formation of an association for the adherence to Evangelicalism.—Jan. 31.

## ECCLÉSIASTICAL.—Continued.

Manning Cardinal, Jubilee of Pope, sends a gold medal.—Jan. 10.  
 Montreal, Dowd Father, denounces Illinois Catholic order of Foresters.—Jan. 20.

Montreal, death of Rev. Canon Belcher.—Jan. 23.

New York, Archbishop Corrigan issues circular as to attendance at meetings of Anti-poverty Society.—Jan. 20.

New York, Archbishop Corrigan's letter denounced by Dr. McGlynn, as a gross piece of impudence.—Jan. 20.

New York, burial case, McGuire Phillip v. Trustees of St. Patrick's Cemetery, decision by Judge Beach.—Jan. 8.

St. Asaph, death of Right Rev. Joshua Hughes, Bishop.—Jan. 22.

Summerside, P.E.I., Father Doyle celebrates his silver jubilee.—Jan. 26.

Toronto, investigation of charges against Rev. T. W. Jeffrey commenced in Methodist Book Room.—Jan. 10.

Toronto, Rev. Canon Knox-Little commences series of Mission services.—Jan. 17.

Washington, National convention of colored Catholics opened at.—Jan. 2.

Eclipse of the Sun, observations in different parts of California and Nevada.—Jan. 2.

Edgely Mrs. Nancy, aged 104, dies at Wolfboro, N.H.—Jan. 26.

Educational, American Public School system, Cardinal Manning's paper upon.—Jan. 8.

EGYPT.—Khartoum threatened with attack from the South, Mahdi recalls dervishes from Suakim to Wady Halfa.—Jan. 16.

Mahdi countermands order to Governor of Berber to leave that place with his army for Upper Nile.—Jan. 15.

British secret mission to Sir Phillip H. W. Currie, assistant private secretary in office of Sir James Ferguson, under Foreign Secretary, departs on.—Jan. 10.

ELECTIONS, France, Seine, Boulanger's address to the electors.—Jan. 3.

France, Corsica, M. Morell elected member of French Senate for.—Jan. 14.

France, Cotes du Nord, M. Ollivier, monarchist, elected Senator.—Jan. 13.

France, Seine, Boulanger interviewed at Paris, and is confident of success.—Jan. 8.

France, Seine, Socialists meet and vote in favor of Boulanger.—Jan. 7.

France, Seine, Jacques, President of the Council of the Seine, appointed by republican congress to oppose Boulanger.—Jan. 6.

France, Seine, *Soleil* Orleansat paper states that party will support Boulanger against M. Jacques.—Jan. 10.

France, Seine, Revolutionary section choosing M. Boule to oppose Gen. Boulanger.—Jan. 11.

France, Seine, Boulanger issues another manifesto.—Jan. 12.

France, Seine, monarchists issue manifesto to electors.—Jan. 14.

France, Seine, M. Jacques opponent of Gen. Boulanger issues reply to.—Jan. 14.

France, Seine, royalists decide to vote for Boulanger.—Jan. 17.

France, Seine, manifestoes issued for and against Boulanger's candidature.—Jan. 19.

France, Somme and Charente Inferieure, General Montauban and Dupont, both Boulangers, elected.—Jan. 6.

France, Boulanger elected for district of the Seine.—Jan. 27.

France, Cote D'Or, Baray, Republican candidate, elected.—Jan. 27.

France, Rhone, municipal authorities re-elect Numa Gilly as mayor.—Jan. 25.

France, Seine, Boulanger issues letter thanking electors.—Jan. 28.

Cardwell, Election case heard at Montreal.—Jan. 21.

Govan, Scotland, Wilson, Gladstonian candidate, elected.—Jan. 18.

Haldimand, P.Q., Montague Dr., nominated by conservatives.—Jan. 15.

Haldimand, P.Q., writ issued.—Jan. 16.

Haldimand, Mr. U. W. Cotter and Dr. Montague nominated.—Jan. 24.

Haldimand County, Mr. Cottar, liberal candidate elected.—Jan. 30.

Halton, trial of election petition commenced at Milton.—Jan. 29.

Hamilton, Ont., Hon. J. S. Gibson re-elected by acclamation.—Jan. 31.

Joliette, Que., Mr. Neven liberal candidate elected.—Jan. 16.

Kansas Legislature re-elects Senator Plumb, United States Senator.—Jan. 22.

Laprairie, nomination for local legislature.—Jan. 17.

Laprairie, Quebec, Mr. Goyette elected.—Jan. 24.

London, Eng., for London County Council.—Jan. 17.

Lunenburg, N.S., Sperry John D., elected for local legislature.—Jan. 17.

Minnesota, House of Representatives elects Washburn United States Senator.—Jan. 23.

Montreal Centre, Hon. Mr. McShane unseated by decision of the Court.—Jan. 3.



## FRANCE—Continued.

Income tax bill rejected by committee appointed by French Chamber of Deputies.—Jan. 15.

Loforge, Toninac, lapses of, announcement by Minister of Commerce.—Jan. 3.

Landslide at the mouth of toulon between St. Raphael and Cannes.—Jan. 2.

Legion of Honour decorations awarded to foreigners.—Jan. 3.

Marseilles, honour in quarter Belkain collapses, 7 Italians killed.—Jan. 15.

Mines, municipal authorities re-elect N. m. Gilly as mayor.—Jan. 25.

Ministerial Council, Admiral Krantz, Minister of Marine, reports as to instructions issued to Governor of Ubook with reference to Coesack Colonists.—Jan. 26.

Ministry tender their resignations which Pres. Carnot declines to accept.—Jan. 24.

Ministerial crisis, Premier Floquet receives bureau of extreme Left, and announces abandonment of idea of resigning.—Jan. 30.

Naval, decree issued authorizing construction of two ironclad cruisers and fifteen torpedo boats.—Jan. 14.

Naturalisation bill, Mr. Levy, receiver of customs at Mahadiah, Tunis, dismissed in consequence of refusal to register.—Jan. 22.

M. De Lesseps gives a dinner in honor of General Boulanger.—Jan. 23.

Origny, riots by strikers, soldiers sent to suppress rioters.—Jan. 19.

Ordinary garrisons in and about Paris being replaced by troops known to be devoted to the republic.—Jan. 25.

Paris, M. Dondouville presides... meeting of committee of Royalist Right.—Jan. 28.

Paris, M. Clemenceau presides at another meeting of the left, the meeting unable to adopt a single resolution unanimously.—Jan. 30.

Paris, riot at election meeting in Avenue Duquesne.—Jan. 20.

Paris, duel fought between Comudet, member of Chamber of Deputies, and Uhabonlland, editor.—Jan. 24.

Paris, republican congress, Jacques, President of the Council of the Seine, appointed to oppose Boulanger.—Jan. 6.

Pyrenees Orientales, violent storm occurs in, much damage.—Jan. 7.

Seine, anarchist issue manifesto, to electors.—Jan. 14.

Seine, Boulanger Gen., issues another manifesto.—Jan. 12.

Seine, M. Jacques, opponent of General Boulanger, issues reply to.—Jan. 14.

Seine, revolutionary section chooses M. Boule to oppose General Boulanger.—Jan. 11.

Seine, Royalists decide to vote for Boulanger.—Jan. 17.

Seine, Freemasons issue a pronouncement against Boulanger.—Jan. 18.

Seine, Boulanger elected for by large majority.—Jan. 27.

Senate, bankruptcy bill, 24 articles of, adopted.—Jan. 14.

Senate, bankruptcy bill passes.—Jan. 17.

Senate, M. Leroyer's address on, assuming the presidency.—Jan. 11.

Senate approves grand scheme for utilisation of Parisian sewerage.—Jan. 18.

Senate, approves scheme for utilisation of sewerage of.—Jan. 18.

Southern floods cause enormous damage.—Jan. 3.

Free Trade, England, Manchester Chamber of Commerce pass resolution as to goods brought into Great Britain similar to those produced there paying duty.—Jan. 7.

Frontenac county, council decides to petition the Dominion Government to prohibit sale and manufacture of intoxicating liquor.—Jan. 28.

Fruit growers of Nova Scotia adopt resolution urging Dominion Government to open to Windsor, Annapolis and Western counties railway as part of intercolonial system.—Jan. 26.

Gaelic Congress meets at Thurles.—Jan. 23.

Gambling House, New York, raid on one to Sixth Avenue.—Jan. 2.

Garrotting, Kingston, Mr. Armstrong McCormick assaulted.—Jan. 23.

Gavaazi Father, Italian patriot, death of, at Rome.—Jan. 14.

Geban, Mr. George, author, death of.—Jan. 21.

GERMANY.—Berlin Boerse, prices suffer sharp fall owing to rumour that Bismarck had resigned Chancery.—Jan. 7.

And America, Zausibar, American sailing vessel fired on by German vessel.—Jan. 25.

Admiralty, Admiral Von Dergolts appointed chief of.—Jan. 23.

Berlin, festival of the order of Red Eagle, Emperor confers decorations.—Jan. 20.

Berlin, annual fate of Antie Semite Association.—Jan. 22.

Berlin, Play at Opera House relating to the first Hohenzollern elector of Brandenburg, plot ordered by authorities to be changed.—Jan. 5.

Berlin, Socialists arrested for circulating seditious pamphlet.—Jan. 2.

Berlin correspondents of *Le Petit Journal* and *l'Amorité* expelled from.—Jan. 28.

## GERMANY—Continued.

Berlin, proceedings for High Treason institutes against *Krenz Zeitung* for remarks on the publication of indictment against Professor Geffken.—Jan. 30.

Bismarck Princess, serious illness of.—Jan. 10.

Captain Wiseman appointed Consul General at Zanzibar.—Jan. 21.

Circulation by post of Henri Rochefort's paper, the *Intransigent*, forbidden.—Jan. 10.

Correspondents of *Figaro* and *National* of Paris expelled from.—Jan. 26.

Dr. Von Schelling, Imperial Minister of Justice, resigns.—Jan. 25.

Editor of Berlin *Kathener Zeitung* condemned to imprisonment for crime against the sovereign power.—Jan. 30.

Emigration from, for 1888.—Jan. 7.

Emperor reported to have conferred order of the Black Eagle on Herr Von Puttkamer.—Jan. 4.

Emperor orders dismissal of all French cooks employed in Palace at Berlin.—Jan. 18.

Emperor's allowance, Federal Council agrees to support proposal for.—Jan. 21.

Emperor William's birthday, observance of.—Jan. 27.

Friedberg Dr., resigns office of Prussian Minister of Justice.—Jan. 17.

Geffken Prof., released, prosecution against him abandoned.—Jan. 5.

Geffken Prof., liberation of, reasons given by *The Reichsanzeiger*.—Jan. 8.

Geffken affair, rumours of Bismarck's resignation causes prices on Berlin Boerse to suffer sharp fall.—Jan. 7.

Geffken Prof., serious illness of.—Jan. 12.

Geffken Prof., sick with cholera and refuses to be interviewed.—Jan. 14.

Geffken Prof., by command of Emperor, *Die Reichsanzeiger* publishes indictment against.—Jan. 18.

Geffken Prof., examined by Prof. Mendel of Berlin University.—Jan. 19.

Geffken Prof., *Cologne Gazette* prints extracts from Geffken, Stengenbach letters.—Jan. 21.

General Von Schellendorf, Prussian Minister of War, resigns.—Jan. 25.

Lelpaic, President of Superior Court resigns on account of Bismarck's structures.—Jan. 16.

Prussian Lantag, opening of.—Jan. 14.

Reichstag, Africa East, Bismarck disparages reports concerning British Niger Company.—Jan. 15.

Reichstag, Passport regulations in Alsace Lorraine discussed.—Jan. 18.

Reichstag, railway estimates discussed.—Jan. 18.

Reichstag committee on East Africa Bill approves the measure, save for placing East Africa Company under control of Captain Wisemann.—Jan. 28.

Reichstag, East Africa bill brought up speech of Prince Bismarck.—Jan. 24.

Reichstag, East Africa bill passes second reading.—Jan. 29.

Gilman, W. T., John Shaffer, a Bohemian, who blew up a house, killing four people, is lynched.—Jan. 9.

Gladstone Mr. W. E., reception to, at Naples.—Jan. 2.

Gladstone Mr., visits Pompeii.—Jan. 5.

Gladstone Mr. W. E., and The Pope, Gladstone writes to the *Pall Mall Gazette* denying correctness of *Tabat's* version of his letter to Marquis de Riso.—Jan. 8.

Gladstone Mr., Vatican instructs Archbishop of Naples to visit.—Jan. 14.

Gladstone Mr., writes to rector of Naples University, expressing thanks for cordial reception given him.—Jan. 15.

Gladstone Mr., replies to a letter telling a branch of Irish National League called after him.—Jan. 25.

Gold nuggets discovered on Texas Island.—Jan. 23.

Gordon Gen., New York's Sun publishes a Greek's story as to his death despatched by General Grenfell from Simkim.—Jan. 19.

Gould Mrs. Jay, death of, at New York.—Jan. 13.

Grain Blockade at Baltimore, relief of.—Jan. 2.

Grain Exchange, Winslop, annual meeting of.—Jan. 9.

Gray County, Kansas, conflict between towns of Cimarron and Negalla as to which should be county seat, several men killed.—Jan. 12.

Greece, Vienna Bank grants a loan to Greek Government.—Jan. 7.

Grey Earl, issues long manifesto on British policy in South Africa.—Jan. 19.

Guarantee Company of North America, Annual Meeting at Montreal.—Jan. 25.

Harbor defence, New York *World* states powerful company formed to defend entrance to harbor by means of Petroleum.—Jan. 22.

Harrison General, addressed at Indianapolis his old comrades of the Grand Army.—Jan. 2.

- Haunted room, room in St. Louis Hotel where Preller was murdered.—Jan. 22.
- Haverhill, Mass., trouble between General School Board and the French Catholic Parochial School.—Jan. 18.
- HAYTI—Legitimate's General commanding main army seriously defeated at Hurehie, San Domingo.—Dec. 23.
- French fleet invited to come and protect Port-au-Prince.—Dec. 23.
- Uter rout of Legitimate's soldiers, Hypolite's successful troops marching on the capitol.—Dec. 30.
- Admiral Luce leaves Hayti with surrendered American vessel "Haytian Republic."—Jan. 2.
- Port-au-Prince, critical condition of American residents at.—Jan. 2.
- Gen. Hypolite, leader of insurrectionary forces, purchases steamer "Madrid" lying in Erie Basin, New York.—Jan. 4.
- Port-au-Prince, steamship "Haytian Republic" run into by Haytian gooboot "Novelle Voldruge."—Jan. 3.
- Port-au-Prince, United States steamer "Zantie" arrives at New York from.—Jan. 10.
- Samana steamer "Saginaw" sails from New York with rifles and cartridges for, notwithstanding protest of Haytian Minister.—Jan. 15.
- Cannibalism, horrible story told by correspondent of New York Herald.—Jan. 15.
- General Hypolite purchases steamship "G. W. Clyde" at Philadelphia to turn into warship.—Jan. 25.
- Preston, Legitimate's representative says he has received a cable despatch announcing the fall of G. W. Clyde and St. Marc.—Jan. 26.
- Heston Mr. Henneker, M.P., gives facts and figures in support of inclusion of America in proposed scheme of Ocean penny postage.—Jan. 10.
- Hicks Beach Sir Michael, speaks on Irish education and local Government for Irish industries at Bristol, Eng.—Jan. 14.
- Hirsch Baron, scheme of, Rev. Dr. Gottheil of New York speaks on.—Jan. 12.
- Holbrooke, Aris, Gila Bentia, cow-boy dressed as an Apache Indian, descends on Mexican herders in employ of Don Pedro, killing five.—Jan. 17.
- Holland, King of, suffering from inflammation of the brain, prayers for, offered in churches.—Jan. 13.
- Holland, pamphlet issued by Tindall condemning the country's defensive organization on land and sea.—Jan. 24.
- Holmes Dr. Oliver Woodell presents his medical library to Boston Medical Library Association.—Jan. 30.
- Holmes Richard, aged 102, dies at Farmersville, Ont.—Jan. 25.
- Home Rule, Chamberlain Mr. Joseph speaks at, Birmingham.—Jan. 9.
- Home Rule, Parnell Mr. C. S., interviewed by Mr. T. P. O'Connor, published in New York World.—Jan. 6.
- Honors conferred upon prominent Canadians, New Year's list.—Jan. 3.
- Honorable Artillery Company, London, Eng., meeting of, war office requested to hold enquiry into charge of insubordination.—Jan. 14.
- Hudson Bay Company, Sir Donald Smith appointed Governor and Lord Anson deputy Governor.—Jan. 23.
- Hueffer Francis, Ph D., English musical critic and writer, death of.—Jan. 21.
- Hungary, diet of, Army bill, Count Czakay, the new Minister of Education, on the necessity of examination in German.—Jan. 11.
- Hungarian Diet, Army Bill, Count Stephen Karlozi reproaches M Tisza the Hungarian Prime Minister, for lack of candour toward the Emperor.—Jan. 26.
- Hungary, Army bill, immense meeting of students protest against and advocates the creation of a National Army.—Jan. 27.
- Hungary, parliament, scene of great excitement on discovery of detectives in Strangers gallery.—Jan. 28.
- Hungary Diet, military bill passes.—Jan. 29.
- Hungary, Pesh, army bill, riots in consequence of same passing.—Jan. 30.
- Hungary, United States consul at Budia Pesh, Mr. Joseph Black recalled by his Government.—Jan. 30.
- Hungary, demonstrations made against Premier Tisza for his pro-German policy.—Jan. 31.
- Hungary, Najo, epidemic of diptheria at.—Jan. 11.
- Hungary, Pesh, Premier Tisza addresses a deputation from Hungarian Diet, and discusses the European situation.—Jan. 2.
- Hydrophobia, Elizabeth, N.J., John Storms, death of.—Jan. 18.
- Illinois State Legislature, thanked by United States Senator Cullom for electing him.—Jan. 29.
- Immigration, Toronto, Trades and Labor Council pass resolutions on.—Jan. 18.
- Immigration, United States, Bill reported to House on contract, labor and immigration by Ford Committee.—Jan. 19.
- Immigration, Ontario Province of, statistics for year 1888.—Jan. 11.
- Immigrants, Manitoba and Northwest, total number for last year.—Jan. 2.
- Immigrants, United States, Ford Committee at Washington finally agree on tax of \$5 with a view to excluding papers.—Jan. 17.
- Imperial Federation, Mr. W. E. Gladstone, letter of, to Mr. J. Castell Hopkins, secretary of Imperial Federation League.—Jan. 5.
- Imperial Federation League, Ottawa, annual meeting.—Jan. 18.
- Imports, British increase of, during December over year preceding.—Jan. 8.
- INDIA—Madras presidency, resignation of Governor.—Jan. 2.
- Manchovrin, heavy floods accompanied by great loss of life. Jan. 2.
- Indianapolis, Hacker George, anarchist, sentenced to 14 years penitentiary for assault on his employer James Bruce.—Jan. 18.
- Indiana on Fort du Lac reservation testify before U.S. Commissioners at Duluth, Minn., as to deprivations of lumbermen.—Jan. 19.
- International Copyright Association, annual meeting at Boston.—Jan. 2.
- International Maritime Conference, British Government notifies acceptance of invitation to Washington, subject to certain reservations.—Jan. 26.
- Interstate Commerce Commission, Louisville, Ky., Justice Jackson overthrow decision of, and defines powers of.—Jan. 7.
- IRELAND.—Brown, a farmer who took an evicted farm murdered by four men.—Jan. 2.
- Armagh, Lord Lurgan's estate, riot at evictions, number of arrests made.—Jan. 12.
- Arrest of Mr. Sheehy, M.P., at Glasgow, immense crowd assembled to see him depart, and indignation meeting held.—Jan. 22.
- Barr Mr. Powell, editor of *Midland Tribune*, convicted and sentenced for publishing illegal article.—Jan. 25.
- Book on, by Francois De Pressance of Paris, Mr. Gladstone writes cordial letter to.—Jan. 12.
- Carrick on Suir, County Tipperary, trial of William O'Brien for conspiracy commences, riots and escape of O'Brien.—Jan. 24.
- Castleventry, Co. Cork, eviction of tenant named Donovan attended with desperate resistance.—Jan. 12.
- Castle Connell, Limerick, Sheehy David, M.P., warrant issued for arrest of.—Jan. 4.
- Castle Connell, Mr. Finneane, M.P., sentenced to one month's imprisonment under crimes act.—Jan. 4.
- Clonmel, collision between the police and a crowd, many injured.—Jan. 25.
- Clonakilty, Father McCarthy convicted and sentenced.—Jan. 25.
- Clonakilty, Father McCarthy arraigned for inciting to boycott.—Jan. 24.
- Clonmel, O'Brien William, arrives at, and is given ovation.—Jan. 23.
- Condon Mr. T. J. M.P. for Tipperary, seized with summons under crimes act.—Jan. 2.
- County Clar. Sir Augustine Fitzgerald accepts offer of his tenants under plan of campaign.—Jan. 5.
- Crimes Act, Mr. Daly, proprietor of *Connaught Telegraph*, receives three summonses for publishing seditious articles.—Jan. 14.
- Davitt Michael, telegraphs to Patrick Hogan, that rumours of rupture between himself and Parnell are lies.—Jan. 2.
- Down and Connor, letter from the Pope read in churches sympathizing with Irish people.—Jan. 6.
- Denis Kibride, M.P., James Crew, M.P. and Mr. Tully, editor of *Rosemount Herald*, summoned for inciting tenants to adopt plan of campaign.—Jan. 10.
- Dublin, Mr. S. xton, M.P., inducted into office as Lord Mayor.—Jan. 2.
- Dublin, Sullivan Mr. M.P., served with summons while addressing Land League meeting.—Jan. 2.
- Dublin, Vauclieur estates, evictions on sentences on persons who resisted the sheriff continue.—Jan. 3.
- Dublin, conditional writ of *habeas corpus* has been granted for release of Edward Harrington, M.P.—Jan. 15.
- Dublin, Kenmare Estate, Nationalist farmer visited and beaten, and made to promise to abjure plan of campaign.—Jan. 13.
- Dublin, O'Connor John, M.P., arrested for offences under Crimes Act.—Jan. 15.
- Dunfermling and Falcarragh, County Donegal, tenants arm themselves and prepare to resist evictions.—Jan. 2.
- Dunganstown, Wicklow, evictions on Col Charles Tottenham's estates.—Jan. 8.
- Evicted tenants, Croke Archbishop, donates \$50 to fund for relief of.—Jan. 15.
- Falcarragh, evictions on estate of Olyphert concluded, tenant named Curran and inmates of house arrested.—Jan. 2.
- Falcarragh, evictions resumed.—Jan. 10.
- Falcarragh, Kelly Mr., National League organizer, and Father McFadden, arrested for inciting tenants to adopt plan of campaign.—Jan. 16.
- Fluncane Mr. M.P. for Limerick sent to prison for intimidating intending occupants of evicted farms.—Jan. 2.
- Harrington Mr. Edward, M.P., sent to prison for publishing reports concerning suppressed branch of National League.—Jan. 2.

## IRELAND.—Continued.

Harrington Edward, M.P., Exchequer Division of High Court, refuses to confirm conditional writ of *Habeas corpus*.—Jan. 22.

Hume rule, Lord Roseberry speaks thereon, at Scarborough, Eng.—Jan. 23.

Kennare Earl, of estate of, tenants warned by moonlighters against departing from plan of campaign.—Jan. 10.

Kilbride Denis, M.P. for South Kerry, summoned to answer charges under Crimes Act.—Jan. 16.

Kilrush evictions on Vanlestran estates. Twenty tenants arrested for barricading houses.—Jan. 9.

Kildare, warrants issued for J. L. Carew, M.P. for North Kildare, and Denis Kilbride, M.P. for South Kerry.—Jan. 24.

Lucean, Earl of, offers tenants on his estates at Castlebar, County Mayo, release from all arrears, on condition of payment of one year's back rent.—Jan. 22.

Limerick, Reeves Mr., Journalist, committed for contempt of court.—Jan. 14.

Limerick, David Sheehy, M.P. for Galway, sentenced for violating Crimes' Act.—Jan. 29.

Local taxation of, blue book as to, just issued.—Jan. 2.

Londonderry, Members of National League collect clothing for Falcarragh tenants.—Jan. 13.

Loughrea, a policeman joins the nationalists and denounces his comrades.—Jan. 10.

Maryborough, John Dillon makes farewell address at National Convention.—Jan. 16.

Mitchellstown, two sergeants belonging to Royal Irish Constabulary join National League.—Jan. 14.

National League, Gladstone Mr. replies to a letter telling him branch of the League called after him.—Jan. 25.

O'Brien Wm., M.P., served with summonses for conspiring to induce tenants not to pay rent.—Jan. 4.

O'Brien Wm., M.P., convicted and sentenced at Carrick on Sulr.—Jan. 23.

O'Brien eludes the police and addresses meeting of Baron de Freyne's tenants at Castleroe.—Jan. 27.

O'Brien Wm., does not appear, and warrant is issued for his arrest.—Jan. 29.

O'Brien Wm., M.P., arrest of, in Manchester.—Jan. 29.

O'Brien, M.P., arrival of, at Kingston, and is conveyed to Clonmel prison.—Jan. 30.

O'Brien Wm., treatment of, in prison.—Jan. 31.

O'Brien Wm., sleeps upon plank bed at Clonmel.—Jan. 31.

O'Connor John, M.P. for South Tipperary, arrested for offences under Crimes Act.—Jan. 16.

O'Connor John, and Condon Thomas, M.Ps. for Tipperary, sentenced to prison for looting tenants not to pay rent.—Jan. 31.

Olphert estate, Dougal, exciting eviction scenes, severe struggle for possession.—Jan. 2.

Olphert estates, Dougal, more eviction scenes.—Jan. 4.

Parliamentary party, message of thanks from, presented in Senate of State of New York.—Jan. 15.

Pope's message to people of, lead by Archbishop Walsh.—Jan. 2.

Sheehan J. D., M.P. for East Kerry, found guilty of conspiracy.—Jan. 2.

Sheehy David, M.P., arrest of, in Glasgow, for violation of Crimes Act.—Jan. 21.

Sheehy, M.P., arrest on, in Glasgow, Earl of Aberdeen in a speech at Patrick, Scotland, denounced arrest as an anomaly.—Jan. 21.

Thurles, Gaelic congress meets at.—Jan. 23.

Tanner Dr., and O'Connor John, M.Ps., served with summonses to appear before Tipperary Court to answer charges under Crimes Act.—Jan. 7.

Tipperary, warrants issued against Dr. Tanner, Mr. Condon and John O'Connor, M.P., for neglecting to appear to summonses under Crimes Act.—Jan. 10.

Waterford, persons sentenced for participating in "Manchester Martyrs" demonstration taken to prison, serious riot, several persons injured.—Jan. 14.

Irish education and local government aid for Irish industries, Sir Michael Hicks-Beach speaks thereon at Bristol, England.—Jan. 14.

Irish Land Commission, report et. as to judicial rents.—Jan. 4.

Iring Henry, illness of, in London.—Jan. 18.

Islale of Wight, Prince Henry of Battenburg appointed governor of.—Jan. 7.

ITALY arranges for loan for a hundred millions francs from Germany.—Jan. 7.

Floods extend to Baile ant do much damage.—Jan. 4.

Florence, Ouida raises strong protest against destruction of historic portions of.—Jan. 19.

Government decides to augment force on the Red Sea on account of Aschiboff Mission.—Jan. 24.

## ITALY.—Continued.

Naples, reception to Mr. Gladstone.—Jan. 2.

Naples, Gladstone Mr., writes to rector of Naples University expressing thanks for cordial reception given him.—Jan. 15.

Palermo, 24 persons badly injured by fall of roof.—Jan. 16.

Parliament opened by the King.—Jan. 28.

Posilippo, great rock slide caused by eruption of Mount Vesuvius.—Jan. 11.

Rome, Lord Dufferin arrives at.—Jan. 7.

Dufferin Lord, presents his credentials to King Humbert.—Jan. 9.

Italian Engineer officers disgraced, arrested at Wagonrod, Russia.—Jan. 2.

Switzerland, Commercial treaty concluded between.—Jan. 19.

Java, European residents arming themselves, owing to fanatical disturbances.—Jan. 5.

Jesuits estates, Quebec, Pope decides Laval University shall receive one-half of the \$400,000 voted by the Legislature.—Jan. 23.

Jewish race, extinction of, predicted by Baron Hirsch, who is interviewed in Paris by *New York Herald* reporter.—Jan. 12.

Jewish scheme of Baron Hirsch, Rev. Dr. Gottlieb of New York speaks on.—Jan. 12.

Kansas, Gray County, force of men attempts to remove records of County from Cimarron, fight ensues and several men killed.—Jan. 12.

Kansas Senate passes bill to restrict ownership of real estate to American citizens.—Jan. 25.

Kansas, Seward County, great distress in, appeals sent to various places for aid.—Jan. 26.

Kingston, Ont., annual meeting of Board of Trade.—Jan. 18.

Kingston, Ont., Queen's University, Sanford Fleming, C.M.G., elected Chancellor.—Jan. 18.

Kingville, Ont., Natural Gas struck in paying quantities.—Jan. 23.

Kirk Sir John, starts from London to Zanzibar on special mission to endeavor to effect settlement of difficulties in East Africa.—Jan. 19.

LABOR.—Labor Commission, Canadian, meet at Ottawa, to consider their report.—Jan. 9.

Labor Commission, Canadian, Freed Mr. A. T., appointed chairman in place of late Judge Armstrong.—Jan. 9.

Labor Knights of, and Miners Union, riot at Seattle, W.I.—Jan. 4.

Landslide at the mouth of tunnel between St. Raphael and Cannes.—Jan. 2.

Langevin Sir Hector, Montreal, reception to, in the Drill Hall.—Jan. 23.

Leases Grazing, North West Territory, order in Council passed authorizing issuance of leases affecting 366,000 acres.—Jan. 17.

Leasge Mr. Louis, C.E., superintendent of Montreal Water Works, death of.—Jan. 9.

Lonsdale Lord, and party, encountered 100 miles north of Fort Good Hope, a Hudson Bay Co's post on the Mackenzie river.—Jan. 2.

Lottery at church bazaar at Hamilton declared to be gambling.—Jan. 2.

LEGAL.—Millbrook, Ont., breach of promise, Mrs. Reynolds, widow, sues Mr. Jamieson, 70 year old widower, for \$30,000.—Jan. 17.

Death of Sir Wm. Buell Richards, ex-Chief-Justice of Supreme Court of Canada, at Ottawa.—Jan. 26.

England, copyright, Judge North delivers important decision as to copyright in newspaper paragraph.—Jan. 28.

Ireland, Exchequer division of High Court of Justice refuses to confirm conditional writ of *Habeas Corpus* for release of Edward Harrington, M.P.—Jan. 22.

New Brunswick, Judge Tuck decides no attorney can be arrested on Meane process.—Jan. 15.

Ottawa Exchequer Court, new rules and regulations published.—Jan. 11.

Ottawa, Rimouski election appeal, Supreme Court dismisses appeal of Poirier against Fiset, M.P.—Jan. 15.

Ottawa, Railway committee of Privy Council, application by Canadian Pacific Ry. to cross Street Ry., at London, Ont.—Jan. 5.

Ottawa, Manitoba Ry. crossing case, Railway committee of Privy Council gives Portage Road permission to cross C.P.Ry.'s tracks.—Jan. 4.

Ottawa, Railway committee of Privy Council, application by Northern Pacific and Manitoba Co. to cross C.P.R. at Braddon.—Jan. 4.

Ottawa, Railway committee, Northern Pacific and Manitoba railroad applies for leave to cross C.P.R. at Morris.—Jan. 10.

Ottawa, Railway committee, application by Red River Valley Railroad to cross Canadian Pacific Railroad, at Portage la Prairie.—Jan. 10.

Ottawa, Railway Commission, solicitor for Canadian Pacific Railway announces that decision, giving Red River Valley r.y. power to make crossings, was not satisfactory and must be fought out in the Courts.—Jan. 28.

Chicago, Practitioner Dr. Chalmers E., of Norwalk, Ohio, recover verdict for \$10,000, from Lake Shore and Michigan Southern Ry. Co., for false imprisonment.—Jan. 4.



## LEGAL—Continued.

- Chicago, Lathrop & Co. v. Postal Telegraph & Cable Co., decision on motion for new trial.—Jan. 4.
- Habeas Corpus, St. Johns, Que., Morrisette Mr. Roussid, against the Grande Ligue Mission.—Jan. 7.
- St. John, Que., Alexandrine Morrisette, Habeas Corpus granted, and the girl delivered to her father.—Jan. 17.
- International Society for the practical improvement of criminal law agreed upon legal men of nearly all nations.—Jan. 2.
- Louisville, Ky., Justice Jackson overthrows decision of Interstate Commerce Commission, and defines powers of.—Jan. 7.
- Montreal, Portland and Boston Ry. Co. sues Canadian Pacific Ry. Co. for \$1,850,000 for use of Plaintiff's railway.—Jan. 2.
- Montreal, Portland and Boston Ry. Co. sues Passumpsic Ry. Co. for \$175,000 value of stock.—Jan. 2.
- New York, burial case, McGuire Phillip s. Trustees of St. Patrick's cemetery, decision by Judge Beach.—Jan. 8.
- New York, Rosa O'Donovan s. Hermann-Ridder, of *Catholic News* for libel.—Jan. 6.
- New York, Trusts declared by Judge Barrett to be illegal in the case of the people of the State of New York against the North River Sugar Refining Co.—Jan. 10.
- St. Paul, Minn., United States Government sues Northern Pacific Railroad Co. for six million dollars for timber depredations.—Jan. 4.
- Toronto, Jeannette Prior obtains \$2,000 for seduction from E. C. Lloyd.—Jan. 10.
- Toronto, Judge Rose in opening Assize Court denounces Bucket Shops.—Jan. 22.
- Vancouver, B.C., Canadian Pacific Navigation Company obtains injunction against corporation of Vancouver, restraining them from interfering with docking their ships.—Jan. 15.
- Washington, U.S., Patents, Supreme Court renders judgment in case of Beta Refrigerating Company v. Geo. H. Hammond & Co.—Jan. 21.
- Winnipeg, Schnitz Gov. v. Winnipeg, judgment delivered.—Jan. 3.
- Winnipeg, bill in Chancery filed by Canadian Pacific Ry., asking Court to restrain N. P. and M. Ry. from operating or continuing reconstruction of that road.—Jan. 31.
- Local Option law, Trenton, N.J., Democratic caucus decides to pass bill for repeal of.—Jan. 21.
- Logs, Canada, rate reduced to \$2 per 1000 feet, if cut and ready for shipment at date of order increasing duty.—Jan. 21.
- London County, Council elections for.—Jan. 17.
- London, Eng., first meeting of new Council.—Jan. 31.
- Lumbering, Logging on Cour de Orelles and Flambon reservations in Wisconsin, stopped by order of Interior Department.—Jan. 25.
- Lumber, Nova Scotia, eighty-five million feet shipped from, 1888.—Jan. 16.
- Lumber, duty on, important amendment to United States. Tariff bill carried in Senate.—Jan. 22.
- Lumber, East Saginaw, Mich., lumbermen refuse to sell lumber at an advance of fifty cents per 1,000, on prices quoted when mills shut down.—Jan. 18.
- McGlynn Dr., lectures at New York on "Church and State"—Jan. 20.
- National A. P., Dominion contractor, death of, at Toronto.—Jan. 22.
- Macdonald Sir John, 74th birthday of, he is the recipient of numerous telegraphic and other congratulations.—Jan. 11.
- MacDonnell A. G., superintendent of Williamsburg canal, death of, at Morrisburg, Ont.—Jan. 27.
- Mackenzie Sir Murrell, censured by Royal College of Surgeons, London, Eng., for publishing book on late Emperor.—Jan. 14.
- Mails co tract Atlantic, Ottawa, the sub-committee of council upon, meets and considers the question.—Jan. 11.
- Maine, Governor Burleigh inaugurated.—Jan. 3.
- Maize, Hungarian trust, collapses of.—Jan. 4.
- Manchester, Chamber of Commerce passes resolutions as to goods brought into Great Britain, similar to those manufactured there paying duty.—Jan. 7.
- MANITOBA, statistics as to Homestead and Emigration prepared by Mr. C. J. Brydges, Land Commissioner of Hudson Bay Co.—Jan. 9.
- Premier Greenway, at Liberal banquet at Glendon, Man., deals with charges made by newspapers against the Government.—Jan. 25.
- Legislature, re-assembling of House, Judge Killam's report as to charges against Ministers received.—Jan. 31.
- Man-laughter, France, M. Grenouille, formerly Governor of Senegal, found guilty of, and fined 500 francs.—Jan. 10.
- Manning Cardinal, paper upon American public school system.—Jan. 8.
- Manning Cardinal, Jubilee of, Pope sends a gold medal.—Jan. 10.
- Maritime Provincial Grange in session at Halifax, N.S.—Jan. 23.
- MARRIAGES.—Baden, Prince William of, betrothed to Princess Marie, niece of Grand Duke of Baden.—Jan. 5.
- Boston, Anderson Joseph, brother of Mary Anderson, and Barrett Gertrude.—Jan. 3.

## MARRIAGES—Continued.

- Chicago, Babcock James S., who forfeits \$500,000 left him by his uncle in case he does not marry within five years, resolves to admit all applicants for marriage to a competitive examination.—Jan. 22.
- London, Eng., Stanley Hon. Edward, son of Governor General of Canada, & Lucy Alice Montague, daughter of Duke of Manchester.—Jan. 7.
- Newark, N.J., Peter and Barbara Hahn, arrested for violating Statute which prohibits a man marrying his step-mother.—Jan. 28.
- Orleans, Louise, Princess of, betrothed to Prince Alphonso of Bavaria.—Jan. 10.
- Ottawa, Rennie A. E., of Aberdeen, Scotland, to Miss Miall, eldest daughter of Commissioner of Inland Revenue.—Jan. 17.
- Patrol Captain, formerly Private Secretary to Marquis of Normandy engaged to Eckley Miss Blanche, of Boston.—Jan. 15.
- Princess Victoria of Prussia to Prince Alexander of Battenberg, abandonment of.—Jan. 23.
- Quebec, Belmont Mr., of Ottawa, with Miss Shehyn, daughter of Provincial Treasurer.—Jan. 29.
- McGregor Mr. Donald, of Martintown, Gungahary, death of.—Jan. 2.
- Masonic, Germany, Emperor sends letter of thanks with assurance of future protection to Berlin Grand Lodge of Mason for New Year's congratulations.—Jan. 30.
- Massachusetts, State of, places 3 per cent. loan upon favorable basis.—Jan. 11.
- Massawh, Hadab tribe asks for Italian assistance against Osman Dyn.—Jan. 31.
- Measles black, Wkwsau, Ill., 370 cases at.—Jan. 31.
- Medical, Boston, Dr. Oliver Wendell Holmes presents his vast medical library to the Boston Medical Library Association.—Jan. 30.
- Medical, Halifax, death of Dr. J. S. Lathern.—Jan. 27.
- Medical, Ontario physicians, deputation of, ask Government to reduce duty on surgical instruments.—Jan. 31.
- Medical, London, Eng., Royal College of Surgeons censures Sir Morrell Mackenzie for publishing book on late Emperor.—Jan. 14.
- Medical, Mercer County Medical Society examine a man with divided heart.—Jan. 2.
- Menaies, Robert Stewart, M.P. for East Perthshire, death of.—Jan. 25.
- Metals, cobalt and nickel, Dr. Kruss, chemist of Munich, succeeds in decomposing.—Jan. 15.
- Metal company's shares, fluctuations in, step excitement on Paris Bourse.—Jan. 24.
- Meteorology, comet discovered by Prof. Brooks, at Smith's Observatory, Geneva.—Jan. 15.
- MILITARY, Canada, Militia, general orders, changes and appointments.—Jan. 4.
- Canada, arrival of Lansdowne Challenge cup, won by New Brunswick Rifle team at Ottawa.—Jan. 14.
- Canadian, Royal Military College Club, annual meeting of, at Montreal.—Jan. 18.
- Canadian, Brigade Major Taschereau returns to Ottawa from Military tour of inspection through counties of Champlain, Portneuf and Quebec.—Jan. 24.
- England, Captain Lord William Cecil resigns from the Grenadier Guards.—Jan. 17.
- England, Honorable Artillery Company, meeting of, the war office requested to hold enquiry into charges of insubordination.—Jan. 14.
- France, Chamber of Deputies passes recruiting bill.—Jan. 21.
- France, ordinary garrisons in and about Paris being replaced by troops known to be devoted to the republic.—Jan. 25.
- Gen. Middleton receives Major Short's reply to charges made against him by Col. Turnbull.—Jan. 23.
- Halifax, N.S., death of Daniel Wilson, a Batakia hero.—Jan. 19.
- Hungary, army bill debated in diet as to necessity of examination in German, speech of Count Csanik.—Jan. 11.
- Hungary, military bill passes two diet.—Jan. 29.
- Montague Col. George, formerly of Black Watch Highlanders, death of, at Halifax, N.S.—Jan. 11.
- Ottawa, Royal Military College, Col. Panet, deputy minister of Militia has advice from England that authorities extremely well pleased with military knowledge possessed by graduates.—Jan. 18.
- Quebec, Major Short, of "B" battery, placed under arrest for insubordination.—Jan. 13.
- Quebec, Major Short of "B" Battery released from arrest.—Jan. 23.
- Royal Military College, Kingston, London Military correspondent writes to New York paper, praising cadets from.—Jan. 14.
- Russia, Imperial Ukase orders sharpshooters in army of European Russia shall be doubled.—Jan. 14.
- Russia, deputation from regiment of which Emperor Francis Joseph is Honorary Colonel arrives to congratulate him on 40th anniversary of his colony.—Jan. 9.
- Russia, Garrison at Kieff increased by four squadrons of Ural Cossacks.—Jan. 22.

MILITARY—Continued.

Spain, death of General Quesada.—Jan. 21.  
 Sunkim, Welsh troops withdrawn.—Jan. 7.  
 Sunkim, last of British troops leave.—Jan. 25.  
 Millers Association, St. Louis, flour mills closed down with exception of one.—Jan. 3.  
 Millers Association, St. Louis, Mo., issues circular as to amount of wheat and flour on hand in six States.—Jan. 17.  
 Millers, meeting of, at Palmerston, Ont., resolution passed asking Minister of Customs to remedy discrimination against Canadian millers in favor of American.—Jan. 15.  
 Miners, fight between, at Elkhorn, W. Va., five white men and two negroes killed.—Jan. 24.  
 Minnesota House of Representatives adjourns without balloting for United States Senator.—Jan. 23.  
 Mining, coal anthracite company floated in England, by Mr. McLeod Stewart to develop.—Jan. 15.  
 Mining, coal, Centerville, Dak., valuable deposit discovered at.—Jan. 7.  
 Mining, coal, Shenandoah region, Park place, Centralia and all the Lehigh and Industrial collieries shut down.—Jan. 26.  
 Mining, coal, Victoria, B.C., Wellington coal mines shut down.—Jan. 3.  
 Mine inspector of United States, report of accidents for 1888.—Jan. 4.  
 Montague Col. George, formerly of Black Watch Highlanders, death of, at Halifax, N.S.—Jan. 11.  
 Montreal, Conservative Club, dinner at, speech by Hon. C. H. Tupper.—Jan. 7.  
 Montreal Board of Trade, dinner of.—Jan. 23.

MORIER, SIR R. D., charges against, statement by Major Denies, attaché of the German Legation at Madrid.—Jan. 3.  
 Charges against, opinions of London press thereon.—Jan. 4.  
 Charges against, correspondence published between Sir R. D. Morier and Count Herbert Bismarck.—Jan. 4.  
 Charges against, Bismarck Count Herbert at the Emperor's request promises to exonerate Sir Robt. Morier.—Jan. 5.  
 Charges against, Berlin Post withdraws allegations of forgeries.—Jan. 7.  
 Charges against, Ex-Empress Eugenie interviewed thereon at Farnborough, Eng.—Jan. 10.  
 Charges against, the Correspondence de l'Est, of Vienna, confiscated for publishing letter inveighing against conduct of Germany.—Jan. 10.  
 Morier Sir R. D., charges publication of Guffcken indictment, abhors Bismarck to be the author of charges.—Jan. 17.  
 Morocco, special mission appointed by King to congratulate Emperor William on his accession starts for Berlin.—Jan. 23.  
 Murchison letter, statement of Colonel Clarkson, member of the National Republican committee of Indianapolis thereon.—Jan. 3.  
 "Murchison" who sent Pomona letter, real name of, discovered at Los Angeles, Cal.—Jan. 7.

MURDERS, Albany, N.Y., Lyons Mrs. Lottie, shot by George Dillon.—Jan. 2.  
 Albany, N.Y., Fletcher Alice found shot in her room.—Jan. 2.  
 Attempted, Campbell, N.S., Beat W. J., arrested for assault on Ed. M. Watson, discharged at Portland.—Jan. 24.  
 Attempted, Montreal, Sheffield Mr. J. A., superintendent of sleeping car department on Canadian Pacific Railway, shot by Joseph J. Chandler, a porter.—Jan. 14.  
 Brantford, Ont., Almira Winegarten and Mary Winegarten arrested for murder of former's illegitimate child.—Jan. 17.  
 Brooklyn, N.Y., Henry Adams, stableman, arrest of Moses Stenson, John Collier and Keran Graham.—Jan. 26.  
 Bolar, Mercer County, Mo., Henry Thomas, farmer, shoots Samuel and Chas. H. born, for eloping with his daughter, and is captured by a mob and hanged.—Jan. 19.  
 Crete, Zari Stamatakis, his daughter and son-in-law murdered by Brothers Kartzolaka, at Kidonia.—Jan. 22.  
 Eaton, Ohio, Sharkey Mrs., murdered by her son, Elmer Sharkey.—Jan. 16.  
 England, South Perchton, Somerset, girl Davy, 10 years old, outraged and murdered.—Jan. 2.  
 Holbrook, Ark., Gila Bonita, cowboy, kills five Mexican herders in employ of Don Pedro.—Jan. 17.  
 Ireland, Brown, a farmer who took an evicted farm, murdered by four men.—Jan. 2.  
 Jamaica, Kingston, three depraved negroes murdered, sail for arriving at New York believe it the work of "Jack the Ripper."—Jan. 22.  
 Louisiana, Kennedy Wm. L., confined in Southern Indiana penitentiary for murder of David Baker, in 1854. His sister waits upon Governor Gray at Indianapolis, and states she can prove her brother's innocence.—Jan. 20.  
 Mechanicsville, Va., 17 year old daughter of Ivo Weeks forces four of her younger sisters to take poison, two of whom die.—Jan. 22.

MURDERS—Continued.

Montreal, Benson Mrs., prisoner Benson committed for trial.—Jan. 4.  
 Newfoundland, St. John's, man murdered by boys.—Jan. 8.  
 Owen Sound, Ont., Harkness Joseph, a hostler, shot by Moses Moon, a Saugeen Indian.—Jan. 28.  
 Gilman, W. T., Schaeffer, a Bohemian, who blew up James Boydoyle's house, killing four persons, is lynched.—Jan. 9.  
 Scotland, Glasgow, Mary McKenzie stabbed by John Stevenson.—Jan. 3.  
 St. Pierre, Miq., Coupard Francois, a fisherman, two men Neal and Olivier arrested.—Jan. 17.  
 Shuqualak, Miss., four negroes killed by menhunters.—Jan. 2.  
 Tilbury West, Wilson Holton, arrest of Benjamin McLahon at Cottam, Essex County, Ontario.—Jan. 25.  
 Toronto, Lily Charlton, true bill found against druggist J. O. Wood.—Jan. 25.  
 Whitechapel, Eng., arrest of supposed murderer in Tunia.—Jan. 15.  
 Whitechapel, man giving his name as Jack Jones arrested as Jack the Ripper.—Jan. 20.  
 Wilkesbarre, Pa., McClure J. B., paymaster, and Flanagan Hugh, prisoner believed to be in custody of Pinkerton agents at Philadelphia.—Jan. 5.  
 National Liberal Club, London, banquets, Dadabhai Naoroji.—Jan. 22.  
 National Woman Suffrage Association, Washington, opening session held at.—Jan. 21.  
 Naturalization laws, United States, measure proposed to be introduced into Congress by judiciary committee.—Jan. 15.  
 NAVAL, British, Suakmi, English cruiser "Scout" sails from Malta for.—Jan. 7.  
 France, decree issued authorizing construction of two ironclad cruisers and fifteen torpedo boats.—Jan. 14.  
 German, Downer Captain, commander of flagship "Lalpig," dies of fever at Zanzibar.—Jan. 10.  
 German, Admiral Von Dergoltz appointed chief of German Admiralty.—Jan. 23.  
 German, death of Admiral Count Von Montz, Minister of Imperial German Navy, at Berlin.—Jan. 22.  
 Germany, reinforcements for fleet in Samoan waters leave Bremerhaven.—Jan. 23.  
 Great Britain, committee appointed to enquire into late British manœuvres present report.—Jan. 31.  
 Hayti, Gen. Hyppolite purchases at Philadelphia "G. W. Clyde" to turn into war vessel.—Jan. 25.  
 Italy, Government decides to augment force on the Red Sea on account of Aschinnoff Mission.—Jan. 24.  
 Russia places flotilla of war vessel on Vistula river.—Jan. 9.  
 United States, Board of Officers appointed to examine plans of representative Thomas of Illinois for submerging monitor cruiser, report to Secretary of Navy recommending adoption to plan.—Jan. 10.  
 United States steamer "Zentic" arrives at New York, from Port-au-Prince, Hayti.—Jan. 10.  
 United States, "Atlanta" sails for Port-au-Prince to reinforce "Galena."—Jan. 19.  
 United States Naval, appropriation bill, House committee on Naval affairs reports upon.—Jan. 25.  
 Nebraska House of Representatives passes Senate bill as to constitutional license being submitted to a vote of the people.—Jan. 31.  
 Negro enfranchisement, Col. Gates of Alabama speaks on, and states he will discuss question before Congress.—Jan. 17.  
 Netherlands, King of, suffers relapse.—Jan. 12.  
 Newark, N.J., Peter and Barbara Hahn arrested for violating statute which prohibits a man marrying his step-mother.—Jan. 26.  
 Newfoundland, French aggression in, Dalby Rev. Mr., interviewed at Sackville, N.B.—Jan. 3.  
 New Guinea, Mr. Armstrong, Government labor agent, killed by natives on island of Maoboa.—Jan. 26.  
 New Haven, Conn., nine persons rescued from drowning by Fred. Morris, aged eighteen.—Jan. 18.  
 New Jersey, big storm raging, several vessels wrecked.—Jan. 7.  
 New Jersey legislature, bill modelled on Australian system of voting introduced.—Jan. 10.  
 New South Wales, resignation of Ministry.—Jan. 11.  
 New York State senate, Irish parliamentary party, message of thanks from, presented.—Jan. 15.  
 New York, Canal Traffic for 1888, report of superintendent of public works as to.—Jan. 3.  
 New York, Olney Thomas ex-Ald., charged with boiling, second trial of commences.—Jan. 21.  
 New York, Metropolitan Museum of Art, valuable gift of casts, coins, etc., by Mrs. Joseph M. Dressel.—Jan. 18.  
 New York, supervisory board of city civil service board, Mayor Grant asks for resignation of members.—Jan. 31.

Niagara Falls, great fall of rock from Horseshoe fall.—Jan. 4.  
 Niagara Falls, another break away of rock at Horseshoe Falls.—Jan. 13.  
 Nicaragua, severe earthquake shocks, several persons killed, much damage to property.—Jan. 3.  
 Nicaragua, canal bill passed by United States House of Representatives.—Jan. 5.  
 Nicaragua Canal, convention between Nicaragua and Costa Rica as to location of canal signed.—Jan. 18.  
 Nicaragua Canal, Henocal A. G., engineer at Washington speaks on prospect of its completion.—Jan. 23.  
 North Col., gives a remarkable bill in the Hotel Metropole, London.—Jan. 4.  
 North and South Dakota, Montana and Washington, United States Republican Senators in caucus adopt resolution to insist upon admission as States.—Jan. 31.  
 Norwegian settlers in Western Walsh county, suffering and privations of.—Jan. 6.  
 Nova Scotia, Chief Justice McDonald appointed administrator of province during Lt.-Governor's absence.—Jan. 15.  
 Nova Scotia, coal exports from, for 1888.—Jan. 11.  
 Nova Scotia, lumber shipped from, in 1888, account of.—Jan. 16.  
 Norxibe, County Miss., mob law at, forty negro cabins burned and destroyed.—Jan. 18.  
 Obuck, instructions issued to Governor by Admiral Krantz, Minister of French Marine, as to Ouzasck Colonists.—Jan. 28.  
 O'Brien William, M.P., arrest of, in Manchester.—Jan. 29.  
 Odessa, field of ice seven feet thick forms outside sea walls at.—Jan. 11.  
 Oklahoma, 600 families driven out by United States troops.—Jan. 24.  
 Ohio, Senate passes a bill providing that executions shall be by electricity.—Jan. 23.  
 Ontario Legislature, opening of session.—Jan. 24.  
 Ontario legislature, bill as to manhood suffrage introduced and Cabinet changes announced.—Jan. 25.  
 Ontario legislature, commissioner of public works gives statistics as to Railways constructed in the Province.—Jan. 29.  
 Ontario legislature, statement by Minister of Public Works as to cost of New Parliamentary buildings.—Jan. 30.  
 Ontario legislature, bills to enfranchise widows and unmarried women and to amend the law of slander, introduced.—Jan. 31.  
 Ontario Province of, immigrants to, during last year 1888.—Jan. 11.  
 Opium smuggling, Albany, N.Y., several persons punished for smuggling from United States into Canada.—Jan. 18.  
 Palace cars, New York, the Pullman Palace Car Company acquires control of all the palace car companies in the United States, except the Wagner Company.—Jan. 23.  
 PANAMA CANAL, reports from state, Isthmus unaffected by collapse of DeLesseppe's scheme.—Jan. 3.  
 United States Senate Committee on foreign relations report back favorably as to Mr. Edmond's joint resolution.—Jan. 4.  
 Meeting of bondholders offer M. de Lesseppe chairmanship of new canal company.—Jan. 7.  
 Versailles, meeting of 7,000 shareholders, announcement made as to new company.—Jan. 7.  
 United States Senate, joint resolution as to, adopted.—Jan. 7.  
 Unensurers at Panama, total suspension of work on canal feared.—Jan. 4.  
 Two large contractors engaged in construction stop work, and four thousand employees thrown out of work.—Jan. 8.  
 Contractors consenting to receive share in Panama Railway as guarantee for sums becoming due to them.—Jan. 8.  
 New Company, circulars issued to presidents of provincial committees inviting them to secure subscriptions to new company.—Jan. 8.  
 President Carnot declines to receive deputation of shareholders.—Jan. 10.  
 Contractors on Oulebra section offer to continue work at their own expense until January 15.—Jan. 10.  
 Agreement signed with Banque Parisienne for fresh issue of sixty million shares.—Jan. 14.  
 Bankruptcy bill, enabling company to judicially liquidate its obligations passed in French Senate.—Jan. 14.  
 New company, Banque Parisienne assumes entire cost of issue and constitution of.—Jan. 18.  
 M. DeLesseppe issues circular inviting subscriptions for 60,000 500 franc shares.—Jan. 22.  
 Henocal A. G., engineer of Nicaragua canal, speaks at Boston as to prospect of its completion.—Jan. 22.  
 European participation in construction of, United States House committee on Foreign affairs reports favorably on.—Jan. 24.  
 Washington, Secretary of State receives cable message from U.S. consul at Colon, saying affairs at Isthmus are quiet.—Jan. 24.  
 Shareholders, meeting of, report by chief engineer as to outlay necessary to complete canal.—Jan. 26.  
 Two shareholders apply to Paris Courts for summons against M. DeLesseppe, demanding dissolution of present company.—Jan. 31

Pante, Asuay Province, river Outicay overflows and does immense damage.—Jan. 25.  
 Parnell Mr. O. S., interviewed by Mr. T. F. O'Connor as appears in New York World.—Jan. 6.  
 PARNELL TIMES, Moran Card, in an interview at Melbourne, states that Parnell letters were offered to Archbishop Walsh before they were offered to London Times.—Jan. 10.  
 Commission served upon Hon. J. O. Broderick, warden of Merton College, to appear and purge himself of contempt.—Jan. 10.  
 Commission resumes its sittings, William O'Brien appears under citation as to article in *United Ireland*.—Jan. 15.  
 Unannounced, Broderick Hon. M., warden of Martin College, Oxford, on a summons for contempt of court.—Jan. 15.  
 Commission, Patrick Delaney, invincible, informer, gives evidence.—Jan. 16.  
 Commission, W. O'Brien, M.P., discharged with a caution.—Jan. 16.  
 Commission, correspondence between Mat. Harris and Michael Davitt with reference to land agitation law.—Jan. 17.  
 Commission, the Sheffield Telegraph breach of privilege case brought before the court.—Jan. 18.  
 Commission, evidence of Farragher.—Jan. 21.  
 Commission, Farragher deposes Archbishop Walsh advised him not to pay rent.—Jan. 23.  
 Commission, Denis Tubin, member of Kilkenny band of moonlighters, gives evidence.—Jan. 23.  
 Commission, Inspector Rogers testifies to searching house of Mary O'Connor, secretary of Ladies' Land League, at Athlone, and finding letters from Anna Parnell.—Jan. 24.  
 Commission, reading of speeches produced in evidence continued.—Jan. 29.  
 Commission, evidence of Mr. O'Keefe, cashier of Castle Island branch of the National Bank.—Jan. 30.  
 Commission, witness O'Connor makes sworn information that evidence he gave before commission was absolutely false.—Jan. 30.  
 New York, Irish Parliamentary Fund Association issues appeal to Americans for funds.—Jan. 23.  
 Pasteur M., resigns secretaryship of Paris Academy of Sciences.—Jan. 10.  
 Patents, Washington, Bate Refrigerating Company vs. Geo. H. Hammond & Co., Supreme Court of United States renders judgment in.—Jan. 21.  
 Paxton Andrew, agent of Chicago Citizens' League, death of, at Chicago.—Jan. 15.  
 Peace Congress, opening of, at Milan, resolution passed condemning Triple Alliance.—Jan. 15.  
 Peace Congress, Milan, anarchists decide to foment revolution in Europe in the event of war.—Jan. 17.  
 Peace Society, American, at Boston, adopts resolutions of congratulation to United States, Canada and Great Britain.—Jan. 28.  
 Pellegrini, the caricaturist, known as "Ape," death of, in London, Eng.—Jan. 22.  
 Peterboro', Ont., Commercial Union denounced by Dalton McCarthy, M.P. and Col. Dawson.—Jan. 12.  
 Peterboro, Ont., town council adopts petition to the Governor General in favor of prohibition.—Jan. 28.  
 Ptelep Minister, banquetted by Fishmongers' Company at London, Eng.—Jan. 16.  
 Phelps Mrs., wife of United States minister in London, presented with bracelet by Lady Salisbury and Lady Roseberry on behalf of friends.—Jan. 22.  
 Phelps Mr., banquetted by the Lord Mayor of London.—Jan. 24.  
 Phelps Mr., U.S. Minister of Great Britain, banquetted by Century Club of London, Eng.—Jan. 23.  
 Phelps Mr., American Minister, and his wife sail from Southampton.—Jan. 31.  
 Phillips George S., journalist of New York, death of, at Morristown, N.Y.—Jan. 13.  
 Phillips James O. H., Shakesperian biographical, death of.—Jan. 4.  
 Phillips Mr. Halliwell, the late, Shakesperian commentator, will of.—Jan. 10.  
 Pietou, N.S., Mr. McGill, liberal M.P.P. for, publishes an address avowing himself in favor of Annexation.—Jan. 13.  
 Pittsburg, Pa., storm at, buildings blown down, man's lives lost.—Jan. 9.  
 Poland, anniversary of Polish *Emancipation* observed with numerous banquets.—Jan. 24.  
 Phonograph used by Mayors of London and New York, exchanging New Year's congratulations.—Jan. 3.  
 Pompeii visited by Mr. Gladstone.—Jan. 5.  
 POPE THE, position of, International Arbitration on, Gladstone Mr., sends telegram disclaiming accuracy of the translation of his letter.—Jan. 2.  
 And Mr. Gladstone, who writes to *Pall Mall Gazette* denying correctness of the version in the *Tablet* of his letter to the Marquis de Riso.—Jan. 4.  
 Offered Asylum in Madrid by Queen of Spain.—Jan. 5.  
 Congratulates Emperor William, President Carnot and Emperor Francis Joseph on declaration as to European peace.—Jan. 9.

Pope The, illness of.—Jan. 28.  
 Pope the, restoration of temporal power of, meetings at Bruck Salyburg, Mueabruk and other places adopt resolutions condemning restriction imposed by Italian Government on Holy Sea.—Jan. 29.  
 Portugal, Cortes opened by King.—Jan. 3.  
 Postage, Ocean Penny. Heston John Hennaker, M. P., accepts invitation to visit United States to advocate system.—Jan. 2.  
 Postage, Ocean penny, Mr. Hennaker Heston, M. P., gives facts and figures in support of inclusion of America in proposed scheme.—Jan. 10.  
 Postal, Money orders, United States House committee reports favorably on bill to increase maximum amount of international money orders from \$70 to \$100.—Jan. 18.  
 Postage, United States, Hon. John Jaggart recommends to his colleagues the adoption of a two cent letter postage.—Jan. 25.  
 Prussia, Hindersrabt approves East African bill.—Jan. 23.  
 Public Works, Canada, report of Minister for 1888 issued.—Jan. 23.  
 Legislature, the question of Mr. Langelier's employment in the Manitoba railway matter at Ottawa discussed.—Jan. 21.  
 Legislature, debates on Montreal Case case, and the retrocession of Crown lands. The Magistrate's bill passes its third reading.—Jan. 23.  
 Presidential election, New York *World* attacks Cleveland, and maintains the candidate not the party defeated.—Jan. 12.  
 Press, Winnipeg Club, annual meeting of.—Jan. 14.  
 Printers, Wilkesbarre, Pa., strike of, on three daily papers.—Jan. 14.  
 Prohibition, resolution in favor of, passed by counties council of Stormont, Dundas and Clergarry in session at Cornwall, Ont.—Jan. 26.  
 Prussia, *The Correspondence de l'Est* of Vienna confiscated.—Jan. 10.  
 Quance, Panama, en thippee, town of, destroyed.—Jan. 21.  
 QUEBEC. Grand Hotel Scheme, meeting held to form Company for.—Jan. 3.  
 Legislature, opening of.—Jan. 8.  
 Legislature, council passes the address without division.—Jan. 12.  
 Province of, Municipal elections in.—Jan. 14.  
 Legislature, assembly, Government measures introduced, resolution as to election appeals.—Jan. 15.  
 Legislature, Legislative council, Dr. Lavallée expelled.—Jan. 15.  
 Legislature, Assembly, Reformatoria and Industrial School Bill passed controverted election cases, resolution passed, District Magistrate's Court resolutions passed.—Jan. 16.  
 Legislature, bill to amend articles 119 and 999 of the Municipal Code, and that respecting commissions of public employes passed third reading.—Jan. 17.  
 Legislature, Mr. Dunamel's bill, on public lands, discussed in committee.—Jan. 22.  
 Legislature, debate on resolutions with respect of protection of Forests from fire.—Jan. 23.  
 Legislature, sale of liquor to minors discussed, Premier Merrier's views.—Jan. 28.  
 Legislature, bill for preservation of Forests from fire read a third time.—Jan. 29.  
 Legislature, the Quebec Gas charter and Ferry service discussed.—Jan. 30.  
 Debt conversion act, Dominion Government decides not to dilaw.—Jan. 31.  
 Legislature, cost of collecting commercial tax discussed. Public accounts presented.—Jan. 31.  
 Queensland Investment Company, arrest of four Australian directors for swindling ordered by London Board.—Jan. 23.  
 Quesada, Spanish General, death of.—Jan. 21.  
 RAILWAYS. Burlington Road and its officials, amicable agreement arrived at.—Jan. 3.  
 Atlantic Avenue Railway Co., Tie-ups take place in Brooklyn upon all the lines of.—Jan. 25.  
 Brandon, Souris City and Rock Company, notice given of application to incorporate.—Jan. 11.  
 Canadian Pacific gives notice to application to parliament for act to readjust and consolidate the capital charges on its entire system.—Jan. 11.  
 Canadian Pacific applies to Railway Committee of Privy Council for leave to cross Street Railway at London, Ont.—Jan. 5.  
 Canadian Pacific, Chatham, Ont., valators complete their negotiations for right of way through the town.—Jan. 23.  
 Canadian Pacific concludes negotiations with Crawford Estate at Windsor, Ont., for securing Water front.—Jan. 25.  
 Canadian Pacific, delegation from Nova Scotia and New Brunswick interviews the Canadian Government in reference to the short Line Railway question.—Jan. 26.  
 Canadian Pacific and N. P., and M. railway bill filed at Winnipeg to restrain letter from operating and continuing construction of road.—Jan. 31.  
 Cape Breton, decision arrived at to build steel bridge across Grand Harrowa Bras d'Or Lake.—Jan. 8.

## RAILWAYS—Continued.

Caroquet railway, crisis in other details.—Jan. 23.  
 Central Pacific Company declares semi-annual dividend of one per cent.—Jan. 15.  
 Chicago and Grand Trunk, Traffic Manager issues orders as to running of Canadian cars.—Jan. 16.  
 Chicago. Powerful railway syndicate organized to operate in American and Canadian North West.—Jan. 4.  
 Chicago, *Railway Age* on the year's business.—Jan. 4.  
 Chiquetco, Marine Transport Railway, meeting of, at Toronto.—Jan. 17.  
 China, American and German Ministers submit proposals to Chinese Government for concession for constructing railways.—Jan. 5.  
 China, Tientsin Railway, further extension of, prohibited by Imperial decree.—Jan. 29.  
 Grand Trunk of Canada, protest being signed in London, Eng., by shareholders to Governor General against further Government subsidies to competing lines.—Jan. 20.  
 Grand Trunk & Michigan Central Companies, orders received at Detroit that all Canadian cars to be detained until duty paid thereon.—Jan. 15.  
 Grand Trunk, change in official staff announced.—Jan. 21.  
 Hereford branch, tracklaying completed between Cookshire, Que., and International boundary.—Jan. 7.  
 Investors in, New York, *A Sun* gives opinion from Capitalists, Bankers and Merchants.—Jan. 14.  
 Kingston and Smith's Falls Company, bonus by law for \$25,000 adopted at Smith's Falls.—Jan. 15.  
 Masor City and Fort Dodge, Co., Company, defaults on, interest on its bonds.—Jan. 16.  
 Montreal, Portland and Boston Company, annual meeting at Montreal.—Jan. 16.  
 Montreal, Portland and Boston Railway Company takes action against Canadian Pacific Company for \$1,850,000 for use of Plaintiff's railway.—Jan. 2.  
 Montreal, Portland and Boston Company sees Passumpsic Co. for \$175,000 value of stock.—Jan. 2.  
 New York companies refuse to sign new scale recently submitted by employees.—Jan. 11.  
 New York, Central and Hudson River Company, Tillinghast James, assistant president, resigns, and is succeeded by Webb Henry Walter.—Jan. 17.  
 New York, meeting of managers, and important resolutions passed by.—Jan. 11.  
 New York, meeting of Trunk Line presidents; stringent orders issued prohibiting rate cutting.—Jan. 22.  
 Northern Pacific Railroad Co., sued by United States Government for six million dollars for timber depredations.—Jan. 4.  
 Northern Pacific and Manitoba apply to Railway Committee of Privy Council to cross Canadian Pacific Railway at Brandon.—Jan. 4.  
 Northern Pacific and Manitoba applies to Railway Committee for leave to cross Canadian Pacific railroad at Morris.—Jan. 10.  
 Pennsylvania, Statington and New England Railroad Company conveyed to the Pennsylvania, Poughkeepsie and Boston Railway Company.—Jan. 11.  
 Pennsylvania Railway, earnings of all lines running east and west for 1888.—Jan. 24.  
 Philadelphia and Reading Co. annual meeting of shareholders.—Jan. 16.  
 Red River Valley and Canadian Pacific. Barricades pulled down, end of railway war.—Jan. 11.  
 Red River Valley and Canadian Pacific, Privy Council gives permission to cross tracks.—Jan. 4.  
 Red River Valley and Canadian Pacific application before Railway Committee to cross C.P.R. at Portage la Prairie.—Jan. 10.  
 Red River Portage extension track laying resumed.—Jan. 9.  
 Red River Valley and Canadian Pacific. Solicitor for C.P.R. announces to railway commission that the decision as to crossing was not satisfactory and would be fought out in the Courts.—Jan. 26.  
 Regulation of, Wisconsin State Senate, bill introduced into.—Jan. 17.  
 Southern Central. Train seized at Freeville, N. Y., and taken to Auburn by I. A. & W. Railway.—Jan. 3.  
 St. Croix and Penobscot, five miles between Calais and Pricotown, Me seized by Canadian Customs department.—Jan. 28.  
 Turkey, Haidar Pasha-Ismid railroad ordered to be sold to German speculators.—Jan. 3.  
 Vaudreuil and Prescott road, meeting held at L'Original, P. Q., in favor of constructing same.—Jan. 22.  
 Western Freight Association decides to advance rate on dressed beef from Missouri River points to Chicago.—Jan. 11.  
 Raleigh, N. C. Jones James H., former slave of Jefferson Davis, writes to his old master.—Jan. 2.

Reading, Pa. Cyclone wrecks the city, 125 lives sacrificed.—Jan. 9.

Reed George W., editor and stockholder of Brooklyn *Eagle*, dies at New Brunswick, New Jersey.—Jan. 18.

Regina, N. W. T., Liberal conservative association passes resolution condemning attacks made by Winnipeg *Courier* on Mr. Nicholas Flood Davis, M. P.—Jan. 4.

Roberts William Lorman, Baltimore, stock broker and society man, death of.—Jan. 4.

Robbery, Hungary, Roseltze, 23 cans dynamite stolen from.—Jan. 7.

Rossa O'Donovan interviewed as to statements in New York *Catholic News*.—Jan. 6.

Ross Hon. William, resigns his office as collector of customs at Halifax.—Jan. 22.

Royal Military College Club, annual meeting of, at Montreal.—Jan. 18.

RUSSIA. Oarina suffering from mental depression, utmost anxiety for her health.—Jan. 3.

Budget for 1889 shows surplus. The minister of Finance thereon.—Jan. 12.

Bundesrath, East Africa Bill submitted.—Jan. 18.

RUSSIA—Continued.

Oarina affected with a kind of palsy.—Jan. 24.

Imperial Ukase orders that sharpshooters in army of European Russia shall be doubled.—Jan. 14.

Kieff garrison increased by four squadrons of Ural Cossacks.—Jan. 22.

Greiffelingen, late Governor of Reval, dismissed from the public service.—Jan. 11.

Ivangorod, Two Italian engineer officers disguised, arrested at.—Jan. 2.

Over 200 persons reported as having been lost in the snow and frozen to death during past week.—Jan. 4.

Princess Lieven while sleigh riding at Charkoff struck by train and rendered insensible, coachman killed.—Jan. 9.

Places flotilla of war vessels on the Vistula river.—Jan. 9.

Wishniogradske M., finance minister, to be decorated with order of St. Alexander-Newski.—Jan. 14.

Sackville Lord, Murchison letter, statement of Colonel Clarkson member of National Geographic Committee of Indianapolis thereon.—Jan. 3.

Sackville Lord, real name of "Murchison" who sent Pomona letter cleared up at Los Angeles, Cal.—Jan. 7.

Sackville incident. Murchison letter, hunt for and finding Osgood by the author of the letter at Los Angeles, Cal.—Jan. 9.

Sackville incident. Blue book of official correspondence issued by British Government.—Jan. 12.

St. Catharines, Ont., natural gas well torpedoes.—Jan. 24.

St. John, N. B., Taylor Mrs. S. A., of Roxbury, Mass., issues writ against James Williams who had promised to marry her.—Jan. 19.

St. John, N. B., Board of Trade passes resolution urging Dominion Government to require transatlantic mail steamers to make Atlantic terminal point in Canadian port.—Jan. 4.

St. Louis, William Kenne, deformed news boy, dies, and leaves over \$23,000.—Jan. 11.

SAMOA. Germans suffer naval repulse after losing many lives.—Jan. 5.

Battle between Matafa's army and German forces. Secretary of State at Washington receives confirmatory views.—Jan. 8.

Brussels *Nord* says if Germany helps Tannese it is not surprising that Americans side with Matafa.—Jan. 14.

Troubles in, President Cleveland sends a message to Congress on the subject.—Jan. 15.

Rebellion in, Commander Leary of American cruiser "Adams" and Consul Blue-duck are accused by German newspapers of instigating rebellion.—Jan. 10.

Circular sent out by German officers at Samoa regarding late disturbance there published by Honolulu *Bulletin*.—Jan. 15.

German War ships attack Matafa's vessels, and offer insults to Americans and Englishmen.—Jan. 11.

German Gunboat "Olga" conveys Ex-King from Arden to Marshall Island.—Jan. 23.

Reinforcements for German fleet leave Bremenhaven.—Jan. 23.

British Government decides to uphold the treaty precluding European powers from attempting to obtain dominance in Samoa.—Jan. 22.

Germany's action, Senator Edmunds interviewed thereon, at Washington.—Jan. 24.

Germany's action. Secretary Bayard interviewed thereon, at Washington.—Jan. 24.

Member of Senate foreign relation committee explains at Washington that amendments to the Consular bill mean that Samoan autonomy is to be protected.—Jan. 24.

Germany's action. Representative Morrow of California, chairman of the sub-committee of the House Committee on foreign affairs, expresses his opinion of the matter at Washington.—Jan. 25.

## SAMOA—Continued.

Lord Salisbury has interview with German Ambassador.—Jan. 25.

Germany's action, Berlin, Mr. Bayard's implied attack upon German policy causes great irritation.—Jan. 26.

The German Consul at Apia tells his side of the story, in circular letter.—Jan. 28.

Schooner H. L. "Tremen" arrives at San Francisco from Marshall Islands, and gives information as to Mahetou, its deposed King.—Jan. 28.

Letter from J. C. Klein at Apia gives another story as to the actions of Germanis.—Jan. 28.

Senators Hall, Evans and Cameron have interview with Mr. Blaine, thereon.—Jan. 28.

Difficulties discussed in United States Senate, speech by M. Sherman.—Jan. 29.

Secretary Bayard says the whole matter is referred to Congress.—Jan. 29.

President of United States sends message to Congress accompanying additional correspondence.—Jan. 30.

Germans declare war against Matafa.—Jan. 31.

German officials give notice that all vessels arriving there will be searched for articles contraband of war. The Apian police force placed under German control.—Jan. 31.

Secretary Bayard receives despatch that martial law proclaimed by German consul at Apia.—Jan. 31.

San Domingo, revolution in Northern part suppressed and participants arrested.—Jan. 3.

Schultz Governor vs. Winnipeg. Judgment delivered at Winnipeg.—Jan. 3.

Schultz Governor, thrown from his conveyance at Winnipeg, and breaks his left arm.—Jan. 21.

Scottish Mineral Oil Association agrees to continue agreement with American companies.—Jan. 18.

Scott Act, Ontario County, petition for repeal of, deposited with Registrar at Whitby.—Jan. 22.

Scott Act, Petitions received by Department of Justice at Ottawa for repeal of, from City of St. Thomas, Counties of Brant, Wellington, Peterborough, Kent, Frontenac, Lennox and Addington.—Jan. 21.

Seattle, W. T., riot between Knights of Labor and Miners Union.—Jan. 4.

Senegal, (grenville M., formerly governor of, found guilty at Paris of manslaughter, and fined 600 francs.—Jan. 10.

Seduction, Toronto, Prior Jettette, of Newmarket, recovers \$2000 damages from Ellsworth Charles Lloyd.—Jan. 10.

SERVIA.—Arrest of radical members of Servian Chamber of Deputies on suspicion of being implicated in conspiracy against King Milan.—Jan. 2.

Skuptschina, revised constitution passed.—Jan. 2.

King threatens to dissolve parliament unless constitution passed as it stood.—Jan. 2.

New political group being formed at Belgrade aiming at territorial extension of Servia.—Jan. 2.

King closes the Skuptschina.—Jan. 3.

King Milan rejects Gen. Grutch's proposed Cabinet.—Jan. 11.

Members of Ministry resign, General Grims consents to form a Cabinet.—Jan. 8.

Royal divorce arrangement between King Milan and Queen Natalie, by which the latter refrains from further proceedings.—Jan. 10.

Shepard C. A. B., of firm of Lee & Shepard, book publishers, Boston, death of.—Jan. 25.

SHIPPING.—American brig "Atalza" wrecked at Renewa, Newfoundland.—Jan. 2.

American brigantine "Atalza" lost near Renewa, Newfoundland and seven men drowned. Arrival of Captain Brown at Halifax, N.S.—Jan. 9.

Austrian ship "Lord Warden" from Monte Video to Philadelphia out 108 days, all hope abandoned.—Jan. 15.

British ship "Sir Walter Raleigh" from Sydney, N. S. W., goes aground at Boulogne. Five men drowned.—Jan. 29.

British steamer "Orion" from Liverpool to Hong Kong, wreck of, on Spanish coast.—Jan. 12.

British steamer "Leverington" ran into and sank by British steamer "Lanaba" in the Mersey.—Jan. 10.

British steamship "Montana" collides with North German Lloyd's steamer "Main" off North Point, and sinks, chief engineer Young killed.—Jan. 7.

Brooklyn, N. Y., brutal treatment of Malay seamen on steamship "Sophia Joachim" from Calcutta.—Jan. 12.

Canadian Pacific Navigation Company obtains injunction against corporation of Vancouver, B. C., restraining them from interfering with docking their ships.—Jan. 15.

## SHIPPING—Continued.

- Canadian Inland Marine Association finishes its annual meeting at Toronto.—Jan. 10.
- "Gulf of Quayaquil" from Liverpool to Valparaiso, supposed loss of.—Jan. 2.
- Hullisa and Boston, big cut in passenger rates.—Jan. 7.
- Hudson River, steamer "Norwich" with tug passes Newburgh, N. Y., towing a dozen loaded barges, most extraordinary event in navigation for time of year.—Jan. 4.
- Large steamer wrecked off Seicrag Islands, 100 lives lost.—Jan. 12.
- Merchant Seamen deserters, agreement between Great Britain and Brazil relative to.—Jan. 25.
- Ottawa "Eddy" fleet sold to Messrs. D. Murphy & Co., for \$32,000.—Jan. 15.
- Port-au-Prince, Haiti, steamship "Haytian Republic" run into by Haytian gunboat "Novelle Valdrago."—Jan. 3.
- Pennington, Miss., steamships "Sarab" and "H. C. Warmouth," collide on Pearl River.—Jan. 1.
- Pombambo, steamer "Stephen D. Hooper," from Calcutta to New York, burned at sea.—Jan. 3.
- St. John, N. B., Board of Trade passes resolution urging Dominion Government to require transatlantic mail steamers to make Atlantic terminal point in Canadian port.—Jan. 4.
- Steamship "Egypt," from Queenstown, to New York, fire amongst cotton cargo.—Jan. 10.
- Steamer "Parla C. Brown" from New Orleans to Cincinnati suke at Hermitage Landing, Pointe Coupee, Parish, La.—Jan. 5.
- Steamer Phyeuket sunk by collision with unknown steamer off Singapore, 42 persons drowned.—Jan. 15.
- Silk trade, London and Lyons, syndicate formed in largest firms in.—Jan. 4.
- Sekkim, negotiations between English and Chinese governments result in agreement that Indian Government shall have control of.—Jan. 7.
- Sekkim, negotiations between China and India at a standstill, owing to objections by Tibetans.—Jan. 11.
- Skeena River, steamer "Cariboo Fly" returns to Victoria, B. C., from exploration on.—Jan. 18.
- Slavery, Spain Queen of, lends her support to anti-slavery crusade.—Jan. 2.
- Slavery, Zanzibar, hundreds of slaves liberated on New Year's Day.—Jan. 1.
- Small-pox, New York State Board of Health sends out circular as to epidemic existing in several cities in Central New York.—Jan. 29.
- Small-pox, Oberlin, Kan., 21 cases at.—Jan. 28.
- Small-pox, Onondaga, N. Y., three deaths at the poor house.—Jan. 31.
- Small-pox, Syracuse, N. Y., breaks out at the County House.—Jan. 28.
- Smallpox, Vancouver, B. C., passengers from Steamer "Premier" refused a landing.—Jan. 12.
- Smuggling Opium and Chinese, seizure of, on British sloop "Emerald" at Port Discovery Bay.—Jan. 12.
- Socialism, Vienna. Socialist leader Becker and 27 others arrested.—Jan. 14.
- Socialists, Berlin, arrested for circulating seditious pamphlets.—Jan. 2.
- Socialists, congress at Hainfeld, Austria.—Jan. 2.
- Socialism, France, Paris, socialists meet and vote in favor of Boulanger for candidate for the Seine.—Jan. 7.
- Smallpox, Lyons, N. Y., epidemic of.—Jan. 2.
- Smallpox, Vancouver, B. C., steamship "Premier," arrives from Seattle with case on board.—Jan. 6.
- Small-pox, Ashtab, Monroe County, epidemic of, raging, authorities apply to those in Detroit for nurses.—Jan. 22.
- Small-pox, Cornell University, Ithaca, N. Y., case at, students ordered to be re-vaccinated.—Jan. 18.
- Small-pox, Denver, Col., epidemic raging at.—Jan. 21.
- Small-pox, Detroit, The Health officers ask to have bank tellers vaccinated to obviate contagion from paper money.—Jan. 23.
- Smithsonian Institution, Washington, gross irregularities charged against Directors.—Jan. 18.
- Smuggling Opium, Albany, N. Y., several persons punished for smuggling from United States into Canada.—Jan. 18.

## SPAIN—Astric's explosion in Oiler oilery.—Jan. 4

- Barcelona, dynamite cartridge exploded in house of largest weaver in City, servant injured, several persons arrested.—Jan. 18.
- Madrid, man arrested for forging Spanish bonds to the amount of \$500,000.—Jan. 22.
- Madrid, man about to throw petard into office of Minister of Justice arrested.—Jan. 23.
- Madrid, bomb explodes while audience leaving Opera theatre.—Jan. 5
- Madrid, attempt to blow up the Royal Palace with a petard.—Jan. 8
- Madrid, petard explosions, three persons arrested.—Jan. 17.

## SPAIN—Continued.

- Senator Zorilla secures two vessels to raise revolt against the Government.—Jan. 9.
- Valencia. Attempt to blow up place of Archbishop.—Jan. 14.
- Queen of offers Asylum to the Pope in Madrid.—Jan. 9.
- SPORTS.—Carnival, Albany, N. Y., programme for.—Jan. 3.
- Carnival, St. Pauls, abandoned on account of the mild weather.—Jan. 8.
- Curling, St. Paul and Minneapolis part of annual curling contest for McClintock Medal, result of.—Jan. 21.
- Hunting, Montreal, annual meeting and election of officers.—Jan. 16.
- Quito, Montreal, Club, annual meeting of.
- Dominion Club, annual meeting of.—Jan. 18.
- Skating, Amsterdam, Von V. uschin beats Donoghue.—Jan. 13.
- Skating, Hamburg, Joseph F. Donoghue, of Newburgh, wins ladies' gold cup in International Skating contest.—Jan. 14.
- Skating, International championship contest at Vienna.—Jan. 13.
- Skating, Amsterdam, race for amateur half mile skating championship of the world won by Von Vausebin of St. Petersburg.—Jan. 8.
- Skating, Minneapolis. Twenty mile race for championship of the World between Axel Palsen of Norway and Rudolph Goetz of Milwaukee.—Jan. 29.
- Skating, New York, Van Courtland Lake, American figure skating championship won by Mr. Louis Rubenstein.—Jan. 30.
- The ring, James Smith accepts Mitchell's challenge to box in London with small gloves for £500 a side.—Jan. 31.
- The ring, Stockton Range, Philadelphia, Frank Murphy of England beats Jimmy Hagan of Philadelphia.—Jan. 3.
- The ring, Toronto, articles signed between John L. Sullivan and Jake Kilrain, for \$10,000, and *Police Gazette* bet.—Jan. 7.
- The ring, Wisconsin Legislature, bill making Prize-fighting a penal offence introduced.—Jan. 24.
- Trotting, Racine, Wis., trotting horse "James O," sale of.—Jan. 4.
- Yachting, New York, famous yacht "Vouintee" purchased by member of the Seawanhake Yacht Club.—Jan. 23.
- Springer, Okalaoma, Marital law, order put in force and squatters decamp.—Jan. 6.
- Stanhope Hon. Edward, British Secretary of State for war, speaking at Horncastle, Lincolnshire, predicts European War.—Jan. 28.
- STANLEY LORD and Lady, Toronto, reception to.—Jan. 2.
- STANLEY H. M., Sir Francis de Winton receives telegram that Stanley's correspondence detained at Stanley Falls.—Jan. 2.
- Junker Dr., writes to the *Deutsche Wochenblatt*, as to Stanley's safety.—Jan. 10.
- New York World makes arrangements for exploring expedition into Central Africa.—Jan. 13.
- British Government receives letters from.—Jan. 15.
- Benesels, letter from Stanley to Tippod Tib, received in Brussels.—Jan. 16.
- Sir Francis de Winton gives his opinion upon his whereabouts.—Jan. 17.
- Messenger arrives at Sunkin from Khartoum, and says Stanley and Emin Bey are prisoners up the Nile.—Jan. 23.
- STRIKES.—Brakemen and yardmen, Lake Erie and Western Railway, at Lima, Ohio.—Jan. 2.
- Birlington Railroad and its officials, amicable agreement arrived at.—Jan. 3.
- Carpet Workers, New York, girl strikers assault non-Union carpet workers.—Jan. 29.
- Cigar makers, Cuba. Ends in victory for workmen.—Jan. 31.
- Coal dock laborers at Duluth and West Superior.—Jan. 3.
- Coal heaver, Duluth, Minn., riots at.—Jan. 4.
- Feather girls, New York, 1000 girls strike in consequence of Feather manufacturers combinations.—Jan. 25.
- France, Origny, riots by strikers, soldiers sent to suppress rioters.—Jan. 19.
- Miners, Seattle, Knights of Labor order general lock-out of the Oregon Improvement Company.—Jan. 24.
- Loco. Engineers, Chief Arthur of the Brotherhood of Locomotive Engineers interviewed thereon at Cleveland, Ohio.—Jan. 3.
- Mining, Wellington Coal mines, British Columbia, shut down.—Jan. 3.
- Miners, Victoria, B. C., Wellington mine strike ended.—Jan. 17.
- Printers, Wilkesbarre, Pa., on three daily papers.—Jan. 14.
- Q strike, Chicago, settlement of.—Jan. 9.
- Seaman, Glasgow, twenty steamers detained at.—Jan. 31.
- Seamen, Glasgow, the strike from Liverpool extended.—Jan. 29.
- Seamen, Liverpool, riotous proceedings.—Jan. 27.
- Street car employees, Brooklyn, N. Y., President Richardson threatens to hire new bands, riot expected.—Jan. 25.

## STRIKES—Continued.

- Street car employes, Brooklyn, body of Henry Adams, stableman, found beside stable of Ninth Avenue line.—Jan. 20.
- Street car employes, New York, tie-up of car lines, savage assault on Peter M. Sornery, an Italian.—Jan. 29.
- Street car employes, New York, strikers remain in secret session, cars on Third Avenue line stopped and smashed.—Jan. 20.
- Street car employes, New York, band to band fight between strikers and police in the streets.—Jan. 29.
- Street car employes, (the road notify old employes they must return to work or consider themselves discharged).—Jan. 31.
- Street car employes, New York, Broadway road secures 700 men in Philadelphia.—Jan. 31.
- Weavers Union meets at Fall River, Mass., and determines on strike unless increase of wages granted.—Jan. 17.
- Sun, eclipse of, observations in different parts of California and Nevada.—Jan. 2.
- Sanbury, Penn., wind blows over new mill, burying eighteen men.—Jan. 10.
- Switzerland and Italy, Commercial treaty concluded between.—Jan. 19.
- SUAKIM.—Arab women captured by the rebels.—Jan. 2.
- Dervishes accuse Osman Digna of treachery.—Jan. 2.
- Parade by Egyptian officers and men, addressed by Gen. Grenfell.—Jan. 2.
- One of Osman Digna's Lieutenants deserts and reports that rebels are enraged with Osman Digna, and confirms report of Emin Bey's capture.—Jan. 5.
- General Grenfell and staff sail aboard the "Damnhour."—Jan. 5.
- Skirmish with the rebels who retire after abort engagement.—Jan. 7.
- Welsh troops withdrawn.—Jan. 7.
- English cruiser "Scout" sails from Malta for.—Jan. 7.
- Blue book issued, showing Sir Evelyn Baring's forecast.—Jan. 11.
- Battle at, General Grenfell's official report of.—Jan. 12.
- Large force of Dervishes leave Dougl and advance towards Wady Halfa.—Jan. 14.
- In reply to Governor General's proclamation inviting tribes to expel dervishes two Hadendoma tribes express their willingness but inability to do so.—Jan. 14.
- Messenger sent to Khartoum early in November returns with news of death of Lupton Bey.—Jan. 18.
- Pilgrims from Berber report Mahdi has suffered defeat on the White Nile, towards Wadalar, at the hands of regular troops.—Jan. 21.
- Last of British troops leave.—Jan. 25.
- Merchant arrives at, from Khartoum, and confirms report that Mahdi was defeated by Senussi.—Jan. 16.
- Switzerland, death of M. Carteret, leader of Radicals.—Jan. 20.
- Tariff bill passes United States Senate.—Jan. 22.
- TELEGRAPH.—Chicago companies liability as to mistakes C. L. Lathrop & Co. v Postal Telegraph and Cable Co., decision on motion for new trial.—Jan. 4.
- Anglo-American Telegraph Company issues report as to result of alteration of rate.—Jan. 26.
- Cuba to Yucatan, Spanish Government grants concession for.—Jan. 22.
- Mackay Bennett Cable Company decides to form connection through Canadian territory with the company's ocean cable.—Jan. 21.
- Montreal Telegraph Company, forty-second annual report.—Jan. 7.
- Montreal Telegraph Company, and Western Union, Mr. O. S. Wood interviewed thereon at New York.—Jan. 8.
- Montreal, annual meeting of Montreal Telegraph Company.—Jan. 10.
- St. John, N.B., Canadian Pacific Railway Telegraph Company opens office at.—Jan. 30.
- Telephone, New Brunswick Telephone Company purchases all rights in New Brunswick of Nova Scotia Company.—Jan. 21.
- Telephone, Nova Scotia Telephone Company holds special meeting, and decides to sell interests in New Brunswick to Bell Company.—Jan. 23.
- Tezadada Island, discovery of rich gold quartz on.—Jan. 23.
- Telephone, Pease Mr. W. F., of Des Moines, Iowa, claims to be original inventor of.—Jan. 10.
- THEATRICAL.—German Berlin authorities direct change in plot of a play relating to the first Hohenzollern elector of Brandenburg.—Jan. 5.
- Cincinnati, Ohio, duel on stage of Standard Theatre between "Running Deer," an Indian Chief, and Capt. Jack Crawford the scout.—Jan. 22.
- Dolaro Madame Selina, singer, and author of a number of plays, dies at New York.—Jan. 23.

## TREATRICAL—Continued.

- Kellygg Opera Company, members of company desert at Buffalo, appropriate money, and start playing on their own account.—Jan. 24.
- London, Eng., Irving Henry, illness of.—Jan. 18.
- New York, Col. Ingersoll blackballed by "Players Club."—Jan. 25.
- Rome, Sarah Bernhardt achieves great success in "La Tosca."—Jan. 25.
- St. Louis, Fire panic at Olympic Theatre.—Jan. 26.
- Theatrical, England, Boucicault Mrs. Dico, née Agnes Robertson, granted a divorce.—Jan. 10.
- Theatrical, London, Eng., Carl Rosa's Opera Company produces Planquette's Opera "Paul Jones."—Jan. 12.
- Tobacco, Cuba, English capitalists purchase two large cigar factories in, and frustrate attempted trust.—Jan. 10.
- Tobacco, Madrid, Syndicate formed in, for disposal of Havana tobacco.—Jan. 11.
- Tonquay Islands, annexation of, by Great Britain discussed in French Chamber of Deputies.—Jan. 21.
- Tonquay Islands, French Minister of Foreign Affairs instructs Ambassador to ask explanation as to British annexation of.—Jan. 21.
- Tonquay Islands, Lord Lytton, British Ambassador at Paris, informs Mr. Goblet that Great Britain has not annexed two of the islands.—Jan. 24.
- Toronto, denunciation of citizens waits on Premier Mowat, and presents petition for exemption of taxation on buildings up to \$500.—Jan. 11.
- Toronto, proposed special charter, public meeting thereon.—Jan. 12.
- Toronto, Board of Trade banquet speeches by Governor General, Senator Drummond, General Middleton and others.—Jan. 4.
- Toronto Board of Trade, election of officers.—Jan. 31.
- Toronto University, Alexander Prof. William J., appointed by Ontario Government to professorship of English language and literature.—Jan. 29.
- Torpedo boat invented by Dr. Gatting interviewed at Hartford, Conn.—Jan. 24.
- Trade, Board of London, returns prepared by, as to British Trade with Canada.—Jan. 10.
- Trades and Labor Congress Toronto, Sir John Macdonald replies to denunciation as to importation of foreign labor.—Jan. 15.
- Trades and Labor Council, Toronto, discuss the immigration question.—Jan. 18.
- Trenton, N.J., Democratic caucus at, decides to pass a bill for repeal of local option law.—Jan. 21.
- Triple Alliance condemned by Peace Association Congress at Milan.—Jan. 13.
- Trusts, copper, European Syndicate refuses to buy any more copper.—Jan. 29.
- Trusts, Cotton thread business England, ring being formed.—Jan. 12.
- Trusts, thread, Coates, Clark & Co., of Paisley, Eng., form trust, and prices advance ten per cent.—Jan. 12.
- Trusts, Tobacco, formed in Madrid for disposal of Havana tobacco.—Jan. 11.
- Trusts, Electric Light Companies at St. Louis.—Jan. 9.
- Trusts, New York, declared to be illegal by Judge Barrett in the case of the people of the State of New York against the North River Sugar Refining Co.—Jan. 19.
- Trusts, steel rail makers, England, agreed upon, French and Belgian makers to join the ring.—Jan. 22.
- Trusts, Tobacco, Havana, English capitalists frustrated.—Jan. 10.
- Turkey, Constantinople, municipal authorities without previous notice insist upon levying tax upon printers and publishers.—Jan. 30.
- Turkey, Haidar Pasha-Ismid Railroad ordered to be sold to German speculators.—Jan. 3.
- Typhoid Fever, Baie St. Paul, Quebec, epidemic of.—Jan. 16.
- UNITED STATES.—House of representatives, election of president and vice-presidents, resolution of Mr. Springer of Illinois.—Jan. 2.
- House of representatives, Nicaragua canal bill passed.—Jan. 5.
- Congress, Samoan troubles, President Cleveland sends message concerning.—Jan. 15.
- Congress, Samoa, President sends message accompanying additional correspondence.—Jan. 30.
- House of Representatives, Diplomatic and Consular bill debated speech by Mr. McAdoo of New Jersey.—Jan. 12.
- House, Naturalization, laws, measure proposed to be introduced into Congress by judiciary committee.—Jan. 15.
- House, Committee on Post Offices reports favorably on bill to increase maximum amount of international money orders from \$70 to \$100.—Jan. 18.

## UNITED STATES—Continued.

- House, Bill reported by Ford committee on contract labor and immigration.—Jan. 19.
- House, Behring sea seal fisheries, Mr. Dingley presents resolution upon.—Jan. 21.
- House Committee on Foreign affairs orders favorable report as to European participation in construction of Panama Canal.—Jan. 24
- House committee on naval affairs reports upon naval appropriation bill.—Jan. 25.
- House committee on commerce authorizes favorable report on bill appropriating \$85,000 for construction of steam tender for Great Lakes.—Jan. 26.
- House of Representatives, petition presented by 13,000 citizens of Utah against admission of that territory.—Jan. 29.
- Senate, fishing in Behring Sea, Senator Hoar moves for papers thereon.—Jan. 7.
- Senate, Panama Canal, committee on foreign relations report favorably as to Mr. Edmond's joint resolution.—Jan. 4.
- Senate, Panama Canal, joint resolution adopted.—Jan. 7.
- Senate, Senator Riddleberger presents resolutions adopted by the state Grange of Virginia, asking that a bounty of 55 per cent. be given on exported agricultural products.—Jan. 8.
- Senate, Free list of tariff bill discussed, debate on importing free fresh fish.—Jan. 11.
- Senate, Tariff Bill, Mr. Blair on The French Canadian People.—Jan. 11.
- Senate, Tariff bill, important amendment as to duty on lumber carried.—Jan. 22.
- Senate, Tariff bill passes.—Jan. 22.
- Senate, British extradition treaty ordered to be discussed in Executive session.—Jan. 22.
- Senate, duties on farm products, petition to increase same presented by Senator Morrill from Vermont farmers.—Jan. 25.
- Senate, Diplomatic bill, Senator Gibson moves an amendment, creating ministers at France, Germany, Great Britain and Russia, ambassadors.—Jan. 28.
- Senate, Diplomatic and Consular bill, Mr. Gibson's amendment agreed to making the title of ministers of France, Germany, Great Britain and Russia "Ambassadors."—Jan. 23.
- Senate, Russian difficulty discussed, speech by Mr. Sherman.—Jan. 21.
- Senate discusses British extradition treaty in secret session.—Jan. 30.
- Senate, Diplomatic bill, amendment raising ministers to rank of ambassadors expected.—Jan. 31.
- Utah, petition presented to United States House of Representatives by 13,000 citizens against admission of that territory.—Jan. 29.
- Vancouver, B. C., injunction against, obtained by Canadian Pacific Navigation Company, restraining them from interfering with docking of their ships.—Jan. 15.
- Vesuvius Mount of, eruption and rock slide at Poshloppo.—Jan. 11.
- Voters lists for Dominion of Canada completed in Government printing office, Ottawa.—Jan. 17.
- Voting, bill modelled on Australian system of, introduced into New Jersey legislature.—Jan. 11.
- Wahalak massacre, four negroes killed at Shuqualak, Miss., by hunters.—Jan. 2.
- Walkerton constitute port of entry for raw tobacco.—Jan. 25.
- Weavers Union, Fall River, Mass., meeting held, and demand of increase of wages determined upon.—Jan. 17.
- Weavers brought from Boston to Cornwall solicit assistance to return home again.—Jan. 24.
- Western Walsh county Norwegian settlers in, sufferings and privations of.—Jan. 6.
- Wheat and flour, Millers Association of St. Louis, Mo., issues circular as to amount of wheat and flour on hand in six States.—Jan. 17.
- WHITE CAPS.—Bedford County, West Va., attack upon a farmer, whom they drive from the county.—Jan. 3.
- Bloomington, Ills., Patsey O'Connell and three other men arrested.—Jan. 27.
- Chicago, Aldermen who cast their vote for elevated road threatened.—Jan. 4.
- Ohio, Ashland County, visit to Jeromeville to the homes of John and Adam Brown.—Jan. 25.
- Pennsylvania, Thomas Hague of Coal Run brutally assaulted by.—Jan. 19.
- West Rutland, Danby and Wallingford, Vt., post warning notices on doors of residences of well-known citizens.—Jan. 29.
- White Caps, Aurora, Ill., depredations at.—Jan. 11.
- White Caps, North Salem, N. H., assault, John Welsh who causes arrest of thirteen of them.—Jan. 17.
- Wilson Daniel, a hero of Balaklava, death of, at Halifax, N. S.—Jan. 19.
- Winan Mr., speaks at Lincoln Club, Brooklyn N. Y., on The Greater Half of the Continent and the relations therewith.—Jan. 12.
- Winnipeg Board of Trade, Hedmond Mr. James, elected president.—Jan. 29.
- Winnipeg Press Club, annual meeting of.—Jan. 14.
- Winnipeg Grain Exchange, annual meeting of.—Jan. 9.
- Winnipeg, imports and exports for 1888.—Jan. 10.
- Winnipeg, Man., Gov. Schultz is thrown from his conveyance, and breaks his left arm.—Jan. 21.
- Wisconsin Legislature, Bill making prize fighting a penal offence introduced.—Jan. 24.
- Wisconsin State Senate, Bill for regulation of Railways introduced into.—Jan. 17.
- Wolf hunt at Carthage, Ill., participated in by 500 men and boys.—Jan. 25.
- Wolves create havoc among stock at Fort Benton, Mont.—Jan. 24.
- Wool manufacturers, Canadian, deputation waits on Government and asks for increase in duty on.—Jan. 23.
- Woman Suffrage Association, Washington, election of officers and close of Session.—Jan. 24.
- Woman suffrage, letter of Mr. Goldwin Smith to London Times thereon.—Jan. 3.
- WRECKS.—Baltimore, Md., British steamer "Macedonia" bound for Hull, Eng., ashore at Craigbill channel.—Jan. 10.
- Austrian Ship "Lord Warden," from Monte Video to Philadelphia out 108 days, all hope abandoned.—Jan. 15.
- Boulogne, British ship "Sir Walter Raleigh" from Sydney, N. S. W., goes aground. Five men drowned.—Jan. 29.
- Canoe, N. S., American Schooner "Bertie Pierce" with cargo of frozen herrings, crew saved.—Jan. 26.
- Cape Hatteras, "Erin" British steamer from Baltimore to Kingston, passengers saved.—Jan. 24.
- "Gulf of Guayaquil" from Liverpool for Valparaiso.—Jan. 2.
- Hermitage Landing, Pointe Coupee, Parish, La., steamer "Paris C., Brown" from New Orleans to Cincinnati sunk.—Jan. 5.
- Hull, Mass., Barge "Bunyan" goes down, crew of four drowned.—Jan. 22.
- Hull, Mass., The "Josephine" dashed to pieces, two of her crew drowned.—Jan. 22.
- Hull, Mass., Tug "Morse" goes down, crew saved.—Jan. 22.
- Mersey, "Leverington" British steamer ran into and sank by British steamer "Lutaba."—Jan. 10.
- Montank Point, L. I., steamer "George Appolo" from Providence for Norfolk.—Jan. 9.
- Newfoundland, "Atalaza" American brigantine lost near Renews, seven men drowned, arrival of Captain Brown at Halifax, N. S.—Jan. 9.
- New Jersey Coast "Merrimac" clipper ship, discovered.—Jan. 29.
- North Point, British steamship "Montana" collides with North German Lloyd's steamer "Main," and sinks, chief engineer Young killed.—Jan. 7.
- Renews, Newfoundland, American brig "Atalaza."—Jan. 2.
- "Snowbird" brigantine of Brunswick, Maine, Captain Thomas Bennett and 2nd mate George Scott, both of New Haven, Conn., drowned.—Dec. 23.
- Singapore, Steamer "Phyapekel" sunk by collision with unknown vessels, 42 persons drowned.—Jan. 15.
- Sierrarga Islands of, large steamer wrecked, 100 lives lost.—Jan. 12.
- Spanish Coast, British steamer "Orion" from Liverpool to Hong Kong.—Jan. 12.
- Yellow Fever, New York, Lieut. Miles of United States steamer "Zanfic" from Hayti dies.—Jan. 14.
- York, Ont., resolution passed by County Council against Annexation.—Jan. 30.
- Zalinski dynamite gun, trial of, at Fort Lafayette.—Jan. 10



# WEBSTER

In various Styles of Binding, with and without  
Patent Index.

The Latest Edition has 118,000 Words, and 3,000 Engravings,—3000 more Words and nearly 2000 more Engraving than found in any other American Dictionary. It also contains a **Biographical Dictionary**, giving brief facts concerning nearly 10,000 Noted Persons. To these features we have

**JUST ADDED (1885),**  
A NEW PRONOUNCING

## Gazetteer of the World,

containing over 25,000 Titles,

*briefly describing the Countries, Cities, Towns, and Natural Features of every part of the Globe.*

### WEBSTER IS THE STANDARD

Authority with the U. S. Supreme Court and in the Gov't. Printing Office and is recommended by the State Super'ts of Schools in 36 States, and by the leading College Presidents of the United States and Canada.

THE LONDON TIMES says: It is the best Dictionary of the Language

THE QUARTERLY REVIEW, LONDON, says: It is the best practical Dictionary extant.

THE CALCUTTA ENGLISHMAN says: It is the most important work of the kind.

THE TORONTO GLOBE, CANADA, says: Its place is in the very highest rank.

THE NEW YORK TRIBUNE says: It is recognised as the most useful existing "work-book" of the English language all over the world.

It is an invaluable companion in every school, and at every fireside. Specimen pages and testimonials sent prepaid on application.

G. & C. MERRIAM & CO., Publishers,  
Springfield, Mass., U.S.A.

## TYPEWRITERS

*New or Second-Hand, of any make*

**BOUGHT, \* SOLD \* AND \* EXCHANGED.**

EVERYTHING GUARANTEED. \*

Good Machines at Half First Cost.

Send for Catalogue describing all Machines.

**NATIONAL TYPEWRITER EXCHANGE,**

163 LaSalle Street. Chicago, Ill.

## Photo - Engraving.

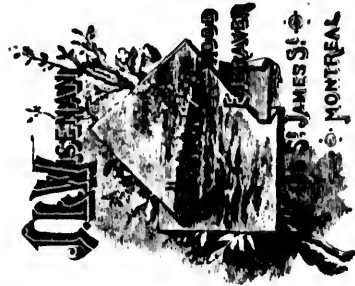

## Pen Drawing & Map Etching.

WHEN  
YOU \* ARE \* READY

To order any more

**BINDING**

**PLEASE CALL UP**

**TELEPHONE \* 230**

Or send a POSTAL CARD to

**JOHN LOVELL & SON,**

23 & 25 St. Nicholas St., Montreal

Best work at moderate prices.

### APPOINTMENT WANTED.

POSITION WANTED as correspondent for any papers or journals of whatsoever character. Am well acquainted with the work.

H. S. PICKETT, 11 Scott, Buffalo, N. Y.

# THE INDEX OF CURRENT EVENTS.

Vol. II. No. 8.

MONTREAL, FEBRUARY 28, 1889.

\$6.00 PER ANNUM.  
PUBLISHED WEEKLY.

## FEBRUARY

**ACCIDENTS.** Drowning, Pine Lake, Fulton County, N. Y., 17 lumber drivers and teams drowned while crossing the ice.—Feb. 5.

**Avalanches,** Bernese Oberland, many houses destroyed and several deaths caused at Obermatt and Solothurn.—Feb. 22.

**Avalanches,** Savoy, Villages of Nivollet and St. Michel destroyed, four persons killed.—Feb. 24.

**Cyclone,** Banks County, Ga., Thomas Stevens and son and Mr. and Mrs. Meaders killed.—Feb. 18.

**Cyclone,** Bibb County, Ala., many people killed and injured.—Feb. 18.

**Explosions,** Hartford, Conn., Park Central Hotel falls down, fifty persons buried.—Feb. 18.

**Explosion,** Mineville, Essex County, Powder Magazine of Port Henry Iron Co.—Feb. 6.

**Fires,** Burnham, 632 houses, a bazaar, and Buddhist monastery destroyed.—Feb. 5.

**Explosions,** Helena Mount, Red Lodge coal mines, five men killed.—Feb. 26.

**Explosions,** Plymouth, Pa., squib factory, ten girls and 1 man killed.—Feb. 25.

**Fires,** Chicago, Deaf and Dumb school for children destroyed.—Feb. 7.

**Fires,** Chicago, Southern Hotel destroyed.—Feb. 13.

**Fires,** De Haynin brick works at Charleroi.—Feb. 27.

**Fires,** Crillac near Eubrun, village burned, 250 persons homeless.—Feb. 25.

**Fires,** Manchester, Eng., Mexican Ives' circus destroyed.—Feb. 26.

**Fires,** Far Rockaway, L. I., Wave Crest Hotel destroyed.—Feb. 11.

**Fires,** Guerneville, Calif., town destroyed.—Feb. 20.

**Fires,** Japan, Shedsnoki, over 1,000 houses destroyed.—Feb. 2.

**Fires,** Japan, Yokosuka, 500 houses and three men burned.—Feb. 3.

**Fires,** Montreal, Peck, Benny & Co.'s foundry and Macdougall's elevator.—Feb. 16.

**Fires,** Philadelphia, establishment of James Wyeth & Bro., manufacturing chemists.—Feb. 10.

**Machinery,** New York Tartar Company, centrifugal machine bursts, killing two and wounding three men.—Feb. 9.

**Poison,** Shelter, Mason County, W. T., J. Bourdeau and two children die from eating poisoned cabbage.—Feb. 9.

**Railway,** Belgium, train near Gouendael goes through bridge, 14 persons killed and fifty injured.—Feb. 3.

**Railway,** Boyd's Mills, Me., train leaves the track and the cars catch fire, three men killed and others injured.—Feb. 23.

**Railway,** Hampton, Ont., Canadian Pacific freight train cuts through Grand Trunk freight train at level crossing.—Feb. 26.

**Railways,** Franco, carriage on express train from Nice to Paris destroyed by fire.—Feb. 12.

**Railway,** Germany, an express train dashes into workmen clearing tracks of snow, ten men killed and eleven injured at Halle.—Feb. 10.

**Railway,** Guelph Junction Railway, express train dashes into train blocked in snow four miles east of Guelph.—Feb. 13.

**Railway,** Prospect Hill, Boston, switching engine jumps the tracks, engine or sortweat and fireman Trenholm killed.—Feb. 5.

**Railway,** Schrieber, Lake Superior district, Trestle work gives way precipitating cars into the gulch.—Feb. 25.

**Railway,** St. George, Ont., St. Louis express goes through the bridge, 9 persons killed and 28 injured.—Feb. 27.

**Shipping,** London, Eng., steamer "Neroid" collides with British ship "Killochan" of Dungeness, and both vessels go down, 24 persons drowned.—Feb. 3.

**Tobogganing,** Brooklyn, cable breaks and car falls 25 feet, 2 men and a woman injured.—Feb. 27.

**Alabama County,** raid made on saloon and gambling house at Prosser.—Feb. 4.

**Adriacople,** great floods prevailing.—Feb. 23.

**Afghanistan,** exportation of goods from, resumed, no obstacle against the importation of Russian goods into the country.—Feb. 16.

**Afghanistan,** Russia notifies England that it would be to the interests of both powers to prevent the Ameer from taking any precipitate steps.—Feb. 9.

**Afghanistan,** Russian troops ordered on a hurried march to re-inforce frontier posts.—Feb. 12.

**Afghanistan,** Gen. Komaroff and staff arrive at Chardjin on the Amu-Daria.—Feb. 12.

**Afghanistan,** insurrectionary leader Ishak Khan being treated with great honor at Samarcand, Russia.—Feb. 13.

**Afghanistan and Russia,** Gen. Komaroff with strong force arrives at Bokhara.—Feb. 14.

**Afghanistan,** Komaroff General, ordered to attack Ameer's troops if they approach Russian frontier.—Feb. 22.

**Afghanistan,** Bokhara troops under command of the Ameer moving toward Afghan frontier.—Feb. 25.

**Afghanistan,** Ameer marching upon Russian frontier and committing cruelties.—Feb. 27.

**Afghanistan,** 18,000 Russian troops being massed on frontier.—Feb. 28.

**AFRICA EAST,** Bagamoyo and Dar-Es-Salem, Mwanga, rallying all the chiefs in favor of Christianity to attack New King Retema.—Feb. 4.

**Trevier Captain,** French Naval officer, organizing expedition for purpose of solving some unsettled problems as to Lake Zanguzka.—Feb. 4.

**Wisman Capt.,** leaves Berlin for.—Feb. 15.

**Wisman Captain** arrives at Alexandria and proceeds to Cairo.—Feb. 25.

**Uganda,** third revolt in, caused King Kiwewa trying to poison his Arab supporters.—Jan. 24, rep. Feb. 25.

**Zanzibar,** Admiral commanding German squadron issues order stopping importation of provisions.—Feb. 23.

**Zanzibar,** German Missionaries held captive by Arabs liberated.—Feb. 27.

**Zanzibar,** Lieut. Wolf and other members of Capt. Wisman's staff arrive at.—Feb. 17.

**Zanzibar,** French vessel boarded by commander of British man-of-war, measures taken in consequence.—Feb. 4.

**Zanzibar,** Germany temporarily suspends negotiations for ransom of German missionaries captured by rebels.—Feb. 5.

**Zanzibar,** Holy of Walsire Arabs surround Sultan's Palace, and demand suspension of blockade.—Feb. 5.

**Zanzibar,** agent of East Africa Company obtains release of Catholic missionaries held by insurgents.—Feb. 8.

**Zanzibar,** insurgents reduce their demands for ransom of German missionaries brought close to Bagamoyo, complete anarchy reigning on coast.—Feb. 8.

**Zanzibar,** hitch in negotiations for release of missionaries.—Feb. 14.

**Anarchism,** Chicago, Prof. J. C. Garside, general organizer and official lecturer of the national socialistic labor party, repudiated by English-speaking socialists.—Feb. 7.

**Anarchism,** Maplewood, Ill., meeting of German workmen to organize branch of the Anarchist Arbeiter Bund of Chicago, broken up by band of women.—Feb. 20.

**Annexation,** Canadian, Mr. Blaine interviewed thereon by Mr. Congressman Milliken of Maine, see *New York Herald*.—Feb. 12.

**Appropriation** accounts for 1888, Auditor General's report upon, issued at Ottawa.—Feb. 4.

**Arkansas legislature,** robbery of ballot box in Pulaski County, resolution offering reward for thieves adopted.—Feb. 2.

**Arkansas legislature,** representatives of Pulaski county, resign, and committee on elections submit report in favor of seating the contestants.—Feb. 18.

**Asbestos,** Theftford Asbestos Mining Co. applies for letters of incorporation at Quebec.—Feb. 24.

**Atchinoff expedition,** French cruiser commanded by Admiral Aubry bombards Singallo, 5 members expedition wounded and others captured.—Feb. 22.

**Atchinoff expedition,** Patriotic League, Paris, resolves to protest against France's treatment of.—Feb. 27.

**Attica, N. Y.,** Although Mrs. Emma, completes the thirty-third day of her sleep.—Feb. 5.

any papers  
all acquainted

Buffalo, N. Y.

Attica, N. Y., Mrs. Emma Allhouse awakens after a thirty-five days sleep.—Feb. 8.

Auditor General's report on appropriation accounts for 1898 published at Ottawa.—Feb. 4.

AUSTRIA, Death of Crown Prince, remains lying in state.—Feb. 4.

Death of Crown Prince, Emperor addresses Holy Father on death of Prince Rudolf, and Pope replies to message.—Feb. 4.

Vienna, Death of Prince Rudolf, several persons arrested in cafes for repeating rumours that Crown Prince met his death at the hands of the husband of the woman he had betrayed.—Feb. 5.

Vienna, funeral of Crown Prince.—Feb. 5.

Vienna, Crown Prince's death, Emperor announces provision to be made for widow.—Feb. 6.

Lalbach, crowd smashes the Bishop's windows, and forces the sexton to toll the bell for Crown Prince.—Feb. 6.

Merau, death of Crown Prince, the Priests refusing to officiate at requiem mass, the people enter church and conduct service.—Feb. 6.

Death of Crown Prince, two letters appear in Paris *Figaro* confirming version of double suicidal tragedy.—Feb. 8.

Death of Crown Prince, Dr. Mettlynn at New York assists the Church for permitting the burial of, with all honors.—Feb. 10.

Death of Crown Prince Rudolf, Countess Larish, daughter of Duke Louis of Bavaria, sentenced to perpetual exile for part she played in the death.—Feb. 25.

Hirsch Baron, donates 120,000 francs yearly to, for relief of tradesmen in danger of financial ruin.—Feb. 27.

Balfour Mr., and O'Brien, the former defends himself in letter to *The Times*.—Feb. 11.

Baltimore, Lee Wiley, from Virginia, while insane, attacks Francis Valentine, peanut vendor, and kills him.—Feb. 5.

Banks, Bank of Bedford, Virginia, suspends.—Feb. 12.

Banks, British Columbia, Bank of, Sir Charles Tupper elected a director.—Feb. 21.

Banks, Germany, *Boersen Zeitung* gives figures showing the rapid growth of banking business since 1865.—Feb. 4.

Banks, County Ga., cyclone passes over, Thomas Stevens and son and Mr. and Mrs. Meaders killed.—Feb. 18.

Bavaria, King Otto proves hopelessly insane.—Feb. 18.

Bavaria, Prince Luitpold, regent of, condemns Countess Larish, daughter of Duke Louis of Bavaria, to perpetual exile for part she played in death of Crown Prince Rudolf of Austria.—Feb. 25.

Bavaria, Prince Rupert, eldest son of Prince Ludwig, and heir to the throne, pronounced insane.—Feb. 23.

Belgium, Radical congress at Brussels supports military education, but demands the abolition of the conscript law.—Feb. 21.

Bell Professor Robert, of Dominion Geological Survey, entertained at dinner party at the Hotel Brunswick, New York.—Feb. 23.

Belle Starr killed at Enfala, I. T.—Feb. 3.

Belle Starr, noted female bandit, advices from Indian territory say her diary has been obtained.—Feb. 16.

Belvidere, Ill., Grand Jury returns in indictments against every liquor seller in the city.—Feb. 16.

Beresford Lord Charles, dines at Berlin with the Emperor and Empress.—Feb. 6.

Bessemer, Wyoming, "Cattle Kate" closes up a gambling house and saves the lives of two gamblers.

Bibb County, Ala., cyclone passes over, killing and injuring many people.—Feb. 18.

Bismarck, Article in Contemporary Review, Empress Frederick denies all knowledge as to authorship of.—Feb. 5.

Bokhara, Ishak Khan and followers, Sultan Murad Khan with 3,000 families of Afghan Weynecs cross the frontier and enter the Bokhara service.—Jan. 19, reported Feb. 18.

Boot and shoe makers and Knights of Labor, movement in Boston to sever the connection between.—Feb. 25.

Bordertown, N. J., Female College, all the seniors withdraw on account of language used by the principal Rev. W. C. Bowen with reference to the state of morals at the present day.—Feb. 21.

Boston, "Old Guard" celebrates its tenth birthday.—Feb. 5.

Boston, Parker memorial building transferred to Boston benevolent fraternity of churches.—Feb. 3.

Brassey Lord, reads paper on "Our Naval position and policy" at United Service Institution, London, Eng.—Feb. 22.

Brewers, Bortholomay, Genesee, and Rochester companies pass into hands of city of London contract corporation.—Feb. 15.

British Columbia fruit growers association formed at Vancouver, B. C.—Feb. 2.

British Columbia legislature memorializes Dominion and Imperial Governments, urging Victoria's claims as a port of arrival and departure for Chinese steamships.—Feb. 21.

British extradition treaty rejected by the United States Senate.—Feb. 1.

British extradition treaty, discussion in United States Senate on motion to remove the injunction of secrecy from the proceedings.—Feb. 11.

Brockville, arrest of Prof. Kaufman, well known musician, for forgery.—Feb. 1.

Brydges Mr. C. J., Land Commissioner of Hudson Bay Company, death of, at Winnipeg.—Feb. 16.

Buffalo, N. Y., Riverside penitentiary, investigation into management being made.—Feb. 6.

Bulgaria, M. Zankoff asserts that Czar informed him he had chosen new prince for, but that time not ripe to name him.—Feb. 22.

Bulgarian bonds, dealings in, forbidden on Berlin Stock Exchange.—Feb. 26.

Canada Atlantic Steamship Company, annual meeting at Halifax, N. S.—Feb. 5.

Canada North-West Land Company, Charles Crews elected director of.—Feb. 14.

CANADA, PARLIAMENT OF, Address in reply to speech from the throne adopted.—Feb. 1.

Senate, report of Mr. Simeon Jones on South America presented.—Feb. 5.

The appointment of Mr. Dewdney attacked by Mr. Laurier, and defended by Sir John Macdonald.—Feb. 6.

Report of Indian department laid upon the table.—Feb. 7.

Honour, estimates for fiscal year presented by Finance Minister.—Feb. 8.

Postage rate, Mr. Haggart announces that it is not the intention of the government at present to reduce the two cent postage rate.—Feb. 11.

House, debate on removal of duty on artificial fertilizers.—Feb. 12.

Estimates considered, those as to Law, Military, department of the Interior, Inland Revenue and Agricultural department considered.—Feb. 12.

House, prohibition resolution of Jamieson introduced and voted away by its own supporters by mistake. The Fertilizers question resuscitated and forced to a vote, and defeated.—Feb. 13.

House, debate on rebate on corn.—Feb. 14.

House, Debate on Marjoe estimates.—Feb. 15.

House, Sir Richard Cartwright's resolution in favor of the Dominion assisting treaty making powers rejected.—Feb. 17.

Mr. Chipman's appointment discussed, bill to amend weights and measures act. Bill respecting bills of exchange, cheques and promissory notes. Bill as to trials of masters and mates of ships.—Feb. 19.

House of Commons, resolution in favor of Home Rule for Ireland given in.—Feb. 19.

Postal department, discussion as to placing post offices.—Feb. 20.

Motion by Mr. Kirkpatrick to allow American vessels wrecking privileges in Canadian waters; prohibition, Mr. Wood's amendment carried.—Feb. 21.

House in Committee of supply, voters lists, seized Canadian Fishing Vessels in Behring's Sea.—Feb. 22.

House, Mr. Davin moves for copies of resolutions forwarded by North West Council to Government. The Pigeon protection act discussed.—Feb. 27.

Senate, British Columbia Coast defences brought forward by Senator McInnis.—Feb. 29.

Senate, Bills passed for repealing bills of lading, to permit the suspension of sentence in the case of first offences and for amending the weights and measures act.—Feb. 26.

Fishery resolutions introduced by Hon. Mr. Laurier.—Feb. 26.

Pigeon protection bill, motion for consideration of bill in committee passed. The North West debate continued.—Feb. 28.

Canadian, American League, Detroit, Canadian residents meet and form.—Feb. 13.

Canadian Phosphate Company, report of issue.—Feb. 7.

Canadian Women's Emancipation Association formed at Toronto.—Feb. 4.

Carruthers Mr. John, death of, at Kingston, Ont.—Feb. 14.

Cattle rates, Kansas, owing to refusal of Railroad commissioners to change their decision as to weighing cattle, rates at all Kansas points must again be made by car load.—Feb. 7.

Celtic Benefit Association, Ottawa, passes resolutions denouncing Salisbury Government for its treatment of Wm. O'Brien.—Feb. 27.

Central Farmers Institute of Ottawa open session at Toronto.—Feb. 5.

Central Farmers Institute, of Ontario, passes resolution that Government grant to Provincial Exhibition should cease.—Feb. 7.

Chamberlain Mr. Joseph, reception given at Glasgow to.—Feb. 11.

Chamberlain Mr. Joseph, Dundee, effigy of.—Feb. 14.

Chamberlain Mr. Joseph, M.P., resigns from Free Land League.—Feb. 25.

Chattanooga Land, Coal, Iron and Railway Company sells controlling interests to a Boston, New York and Philadelphia Syndicate.—Feb. 28.

Feb. 1.  
medion to  
Feb. 11.  
forgery.—  
y, death of,  
ment being  
chosen new  
nge.—Feb.  
fax, N. S.—  
rector of.—  
h from the  
resented.—  
er, and de-  
Minister.—  
ention of the  
rate.—Feb.  
—Feb. 12.  
nt of the in-  
considered.—  
voted away  
estion reus-  
the Dominion  
weights and  
ages and pro-  
of ships.—  
e for Ireland  
—Feb. 20.  
la wrecking  
s amendment  
olan Fishing  
ded by North  
tion act dis-  
ed by Senator  
to permit the  
d for amend-  
b. 26.  
in committee  
et and form.  
at Toronto.—  
ners to change  
as points must  
ouncing Salis-  
—Feb. 27.  
to.—Feb. 5.  
t Government  
Feb. 11.  
gue.—Feb. 25.  
his controlling  
indicate.—Feb.

Chicago, Jens Christiansen, editor of Chicago *Arbeiter Zeitung*, addresses furniture makers, advocating revolution of force and blood.—Feb. 26.  
Chicago Dental Society, annual meeting of.—Feb. 7.  
Chicago, Inspector Bonfield and Captain Schaeck indefinitely suspended from office on charge of corruption.—Feb. 6.  
Chicago, "Billy" Sunday, well-known baseball player, makes his appearance as an evangelist.—Feb. 17.  
CHINA, great distress in Shang Tung, Manchuria and Chen Kiong.—Feb. 5.  
Anbin and Kiangnan, several millions suffering from famine.—Feb. 14.  
Famine in Chen Poo, Missionaries attacked.—Feb. 21.  
Riot at Ching-Kiang-Poo, British man-of-war despatched to protect British subjects.—Feb. 6.  
Tonquin, French troops attack villages of IDinbeintong and Chochu, and route rebels.—Feb. 7.  
Empress Regent on retiring issues decree ennobling three generations of Sir Robert Hart's ancestors, extolling all foreign ministers, and inviting them to a banquet.—Feb. 22.  
Marriage of Emperor.—Feb. 27.  
Chippewa Indians, Fort Pitt, N.W.T., epidemic of virulent character raging amongst.—Feb. 12.  
Christian Alliance, Hamilton, Ont., meetings of alliance at.—Feb. 5.  
Cleveland President, associates himself with law firm in New York City.—Feb. 4.  
Cliff-dwellers tribe, remnant of, discovered in San Mateo Mountains.—Feb. 5.  
Clothing, deputation from Montreal and Toronto wait on Canadian Government at Ottawa to oppose recent plea of woollen manufacturers, for increased tariff on woollen goods.—Feb. 11.  
Coal, Anthracite Coal Companies at Pennsylvania determine to reduce output by shutting down two days each week.—Feb. 22.  
Coal, Blind Souris, Man., rich discovery reported in.—Feb. 6.  
Coal, deputation from Cape Breton waits on Ministers of Finance and Customs at Ottawa, and ask for increase of duty on soft coal from Pennsylvania.—Feb. 6.  
Coal, Philadelphia Coal and Iron Company awarded contract for supplying United States government with 3,000 tons anthracite coal delivered at Samoa.—Feb. 8.  
Colliers, Welsh, give notice that on March 1st they will demand an advance in wages.—Feb. 23.  
Collingwood, Ont., natural gas rushes from baptistry in Baptist Church.—Feb. 25.  
Combines, stove foundries, Maritime Provinces to meet Upper Province competition.—Feb. 25.  
Commerce Chamber of London, Eng., addressed by Lord Salisbury on revival of trade.—Feb. 27.  
Commercial Union with United States, Mr. Towns-head's bill for including Canada in conference, Mr. Erasmus Winant interviewed thereon at New York.—Feb. 15.  
Conteres Gen., disappears from Haytian consulate, New York, and is suspected as sailing on the "Carondelet" carrying cargo of arms for Hippolyte.—Feb. 18.  
Corea, Southern, famine prevailing in, American consul general asks for relief funds.—Feb. 20.  
Cosack expedition under Aschinoff hoists Russian flag at Sagallo under Anglo-French agreement.—Feb. 16.  
Cotton, Stormont Cotton Company, annual meeting of.—Feb. 21.  
Cotton crop, United States, return of Department of Agriculture as to, for year 1888.—Feb. 11.  
Counterfeits in circulation in United States, John S. Bell, chief of secret service of the Treasury, gives evidence concerning, before Senate Finance Committee.—Feb. 7.  
Cowdry John W., mind reader, death of, at New Haven, Conn.—Feb. 5.  
Creek Nation and United States, agreement between, transmitted by President to Congress for ratification.—Feb. 5.  
CRIMES, Absconders, Fall River, Mass., C. H. Wheeler and C. H. Bay, bucket shop proprietors, disappear.—Feb. 4.  
Absconders, Danville, Que., Jerome Daigault, who embezzled \$4,000 from Naphthal Parent, arrested at Pawtucketville, Mass.—Feb. 13.  
Absconders, Denver, Col., William E. Jones, ex-cashier of Continental Oil Company, arrested at Toronto.—Feb. 13.  
Absconders, Geneva, Neb., Supt. Chase of Indian school.—Feb. 15.  
Absconders, Indianapolis, Md., Sullivan John E., County Clerk.—Feb. 1.  
Absconder, Maysville, Ky., Schultz Leuch, city treasurer, disappears.—Feb. 1.  
Absconders, Montreal, Emmanuel Valiquette, notary.—Feb. 15.  
Absconders, New York, Wyatt C. A., woollen merchant.—Feb. 16.  
Absconders, New York, Oookin A. S., cashier of Manabattu Elevated Railway Company.—Feb. 8.

CRIMES.—Continued.  
Absconders, New York, Cleveland A. B., president and organizer of the "A. B. Cleveland Company, Limited," wholesale dealers in seeds.—Feb. 28.  
Absconders, Pickaway County, Ohio, James M. Lane, county treasurer.—Feb. 22.  
Absconders, St. Louis, Dreckmann Henry, member of Merchants Exchange.—Feb. 8.  
Bigamy, Toronto, Richard Cole, trial of.—Feb. 25.  
Burglars, Chicago, arrested at office of W. H. Merigold, banker.—Feb. 5.  
Burglary, Lynn, Mass., Edward Oakes, ex-chief of police of Langus, arrested for.—Feb. 17.  
Counterfeiting, Hutchinson, Kas., Cora Wilson, aged 18, arrested for.—Feb. 8.  
Defaulters, Vermillion County, Md., William L. Porter, ex-treasurer of, \$12,000 short in his accounts.—Feb. 14.  
Defaulters, Fall River, Mass., J. H. Wheeler and C. H. Roe, bucket shop proprietors, disappear.—Feb. 4.  
Defaulters, Geneva, Neb., Supt. Chase of Indian School robs Government of over \$25,000 and absconds.—Feb. 15.  
Defaulters, New York, Cleveland A. B., president and organizer of the "A. B. Cleveland Company, Limited," wholesale dealers in seeds.—Feb. 28.  
Defaulter, Pickaway County, Ohio, James M. Lane, county treasurer.—Feb. 22.  
Forgeries, Brockville, Prof. Kaufman, well known musician, arrested, at.—Feb. 1.  
Incendiarism, Rahway, N.J., Charles Martin sentenced.—Feb. 2.  
Robbery, Chicago, Burglars raid the Hotel Pasadena.—Feb. 4.  
Robbery, England, admiralty official caught and discharged for abstracting documents.—Feb. 11.  
Robbery, Pixley, Cal., Train No. 17 stopped by five men, express car robbed and two men shot.—Feb. 23.  
Robbery, Rock Island train, Ella Schwartz, wife of brakeman now under sentence, confessor on deathbed at Chicago, to receiving \$13,000 of stolen money.—Feb. 4.  
Robbery, Washington, \$4,000 worth of tobacco stamps stolen from Treasury department.—Feb. 23.  
Suicide, Austria, A. Goldsmith poisons himself and five children at Vienna with cyanide of potassium.—Feb. 11.  
Suicide, Bavaria, two persons drown themselves in Lake Starnberg.—Feb. 14.  
Suicide, Castlewood, Dak., Gustaf Johnson takes poison, Dr. Stanley tastes the poison and becomes seriously ill.—Feb. 6.  
Suicide, Chicago, Patrick Healey, aged 69, cuts his throat.—Feb. 7.  
Suicide, Chicago, McAuley Mrs. Lizzie, kills herself with gas.—Feb. 25.  
Suicide, New York, Carrie Nolan aged 17 and James Considine, aged 29, take poison and die.—Feb. 4.  
Suicide, Potsdam, Lieut. Von Berckenheim, aristocratic young officer of Prussian Army.—Feb. 28.  
Suicide, Shanghai, chief engineer Wells of U. S. S. "Omaha," shoots himself in a fit of temporary insanity.—Jan. 8 reported Feb. 14.  
Suicide, Toronto, attempted, by George Austen, tailor, with prussic acid.—Feb. 4.  
Suicide, Vienna, Lieut. Szepeshazy shoots himself.—Feb. 12.  
Suicide, Woodsonville, Ky., Mrs. Sallie Whitman, postmistress, attempts.—Feb. 7.  
Swindling, Oswego, N.Y., Manhard Edward E., of Toronto, arrested for defrauding John K. Post & Co., lumber dealers, of \$2,500.—Feb. 2.  
Swindlers, San Francisco, Big Bertha, "confidence queen," acquitted of fraud on William Graham.—Feb. 2.  
Crofter Colonization, Royal commission on, holds its first meeting in London, Eng.—Feb. 12.  
Croup, diphtheritic, Wabash, Ind., 48 children die from, within two weeks.—Feb. 21.  
Cuba, annexation by United States, Mr. Blaine interviewed thereon by Congressman Milliken of Maine, see *New York Herald*—Feb. 12.  
Cuba, Gen. Salamanca appointed Captain General of, in place of Gen. Marin, resigned.—Feb. 6.  
Customs, Canadian, Fort McLeod, N.W.T., extensive seizure of tobacco from firm of I. G. Baker & Co.—Feb. 1.  
Customs, Canadian report for 1888 published at Ottawa.—Feb. 4.  
Customs, Canadian, soft coal, deputation from Cape Breton waits on Ministers of Finance and Customs, and ask for increase of duty on soft coal from Pennsylvania.—Feb. 6.  
Customs Canadian, Dynamite, Messrs. Fuller & Co., of Halifax, notified Government will refund \$8,000 collected on consignment of dynamite seized at Halifax in April, 1885.—Feb. 11.  
Customs, Canadian, Manitoba, seizure of beer consigned to Colonel Herchmer of North West Mounted Police, official explanation given in Ottawa.—Feb. 9.

- Customs, Regina, Officer Jamieson declines to act in the matter of seizure of beer stored at North West mounted police barracks.—Feb. 7.
- Customs, Sault Ste. Marie, Plummer Henry, appointed collector.—Feb. 8.
- Dairymen, Ontario deputation of, waits on Provincial Minister of Agriculture, asking subsidy to provide for inspection of cheese factories and instruction in cheese and butter making.—Feb. 14.
- Dakota legislature, Woman suffrage bill defeated.—Feb. 8.
- Dakota legislature, Governor Church in message to, bitterly attacks his predecessor.—Feb. 9.
- Dakota, St. John, half-breeds resist collection of taxes, militia called out.—Feb. 15.
- Dakota, celebrates the admission of the territory to the Union as a state.—Feb. 23.
- DEATHS.—Cowdry John, mind reader, at New Haven, Conn.—Feb. 5.
- Bliss Dr. D. W., at Washington.—Feb. 21.
- Bryce Mr. C. J., Land Commissioner of Hudson Bay Company, at Winnipeg.—Feb. 16.
- Carruth Mr. John, death of, at Kingston, Ont.—Feb. 14.
- Caceres Rosa Amelia, daughter of president of Peru.—Feb. 24.
- Chandler Rear Admiral, commanding United States Naval Squadron in Asiatic waters at Hong Kong.—Feb. 10.
- Cunningham Very Rev. Dean, of St. Peter and St. Paul's church, Elmira, N. Y.—Feb. 4.
- Dechen Ernest Henry Charles, German geologist.—Feb. 17.
- Delamater Cornelius H., founder of Delamater Iron Works, at New York.—Feb. 7.
- Dopeyter Nicholas, member of famous Kuickerbocker family, at New York.—Feb. 19.
- Flood James C., Bouazza King, of California, death of, at Heidelberg.—Feb. 21.
- Fisk Mary H., writer, and wife of Stephen Fisk, well known litterateur, at New York.—Feb. 4.
- Friedrichs Gustave A., editor of *Pittsburg Volksblatt* at New York.—Feb. 2.
- General of Augustinian Order in Rome.—Feb. 25.
- Heller Michael, snake-bite doctor, at Reading, Pa.—Feb. 4.
- Hunt Col. Henry L., Governor of the Soldiers Home, in the district of Columbia.—Feb. 11.
- Kattimer Sarah J., philanthropist, at Plainfield, N. J.—Feb. 3.
- Cardinal Ledochowski, formerly primate of Poland and Archbishop of Posen.—Feb. 7.
- Loggworthy D. H. J., physician, of Rochester, N. Y.—Feb. 5.
- Lorway Capt. Charles M., commander of Canadian fishery cruiser, death of, at Sydney, C. B.—Feb. 18.
- McZeire Rev. H. N., senior bishop of Methodist Episcopal church south, at Nashville, Tenn.—Feb. 15.
- Minard Mrs. Margaret, dies at Sparta, Ont., aged 100 years, 6 months and 3 days.—Feb. 17.
- Mackenzie Beator, an old officer who accompanied Dr. Rae on the Franklin expedition, at Winnipeg.—Feb. 1.
- Merrick Judge William M., of the Supreme Court of District of Columbia, at Washington.—Feb. 4.
- Noodie Robert Baldwin, Western representative of Intercolonial Railway, at Toronto.—Feb. 3.
- Montgomery Mrs. Maria F., widow of late Gen. Bacon Montgomery, of St. Joseph, Mo., at Beverly, Mass.—Feb. 7.
- Pitra Cardinal John Baptiste.—Feb. 11.
- Prokopios Monsignor, Primate of Greece, at Athens.—Feb. 11.
- Republican, General Villucampa dies in prison at Madrid.—Feb. 17.
- Rowland Dr., port physician, at Quebec.—Feb. 22.
- Saccconi Cardinal Charles.—Feb. 25.
- Stewart Rev. James, senior Presbyterian Minister in Canada, at Toronto.—Feb. 20.
- Street John W., inventor of improved cattle car, at Chicago.—Feb. 16.
- Street Rev. George Charles, Canon of Cathedral of St. Peter and St. Paul, Chicago, dies in Florida.—Feb. 3.
- Young George Paxton, Professor of mental and moral science at University College, Toronto.—Feb. 26.
- Dechen Ernest Henry Charles, German geologist, death of.—Feb. 17.
- Delamater Cornelius H., founder of Delamater Iron Works, death of, at New York.—Feb. 7.
- Deists, Chicago Dental Society, annual meeting of.—Feb. 7.
- Dopeyter Nicholas, member of famous Kuickerbocker family, death of, at New York.—Feb. 19.
- Detroit, Canadian residents meet and form Canadian American league.—Feb. 13.
- Diphtheria, France, two professors of Pasteur Institution identify the gerative microbe of.—Feb. 5.
- Diphtheria, Kingsville, Ont., family of six attacked with disease.—Feb. 4.
- Diphtheria, Muskoka and Nipissing districts, Ont., Provincial Board of Health considering measures to check.—Feb. 15.
- DIPLOMATIC.—Great Britain and United States, Sir Julian Pauncefote, permanent under-secretary of State for the Foreign office, appointed to succeed Lord Sackville.—Feb. 3.
- Diplomatic and consular appropriation bill, conferees on, at Washington, reach an agreement.—Feb. 9.
- France, relations between President Carnot and Lord Lytton, British Ambassador, become strained on a point of etiquette.—Feb. 18.
- Great Britain and United States, Lord Salisbury denies that Sir Julian Pauncefote has been appointed.—Feb. 8.
- Great Britain and United States, Mr. Edwards, first secretary of legation at Washington, sails from England to assume charge of the affairs of the legation.—Feb. 9.
- Great Britain and United States, Dr. J. G. Selman, professor of philosophy in Cornell University, interviewed at Ithaca as to vacancy at Washington.—Feb. 27.
- Spain and United States, Mr. Belmont, new United States Minister received by queen regent of Spain.—Feb. 13.
- Divorce, Carlton Henry Guy, well known American journalist, sued by his wife.—Feb. 13.
- Divorce, France, Monbeger applies to Pope for, on the ground of irregularity of his marriage.—Feb. 5.
- Divorce, London, Eng., Aylesbury Lord, begins suit against his wife.—Feb. 15.
- Divorce, London, Eng., Mr. Izard against his wife the actress, Maria Temple, with Henry J. Leslie, proprietor of Lyric Theatre, as co-respondent, results in verdict with £5,000 damages for plaintiff.—Feb. 14.
- Dollinger Dr., proceedings at Munich as to congratulating him on the occurrence of his 90th birthday.—Feb. 23.
- Dollinger Dr., originator of Old Catholic movement, banquetted at Munich.—Feb. 28.
- Dominion Alliance, Ottawa, meeting of council, report of Executive Committee.—Feb. 8.
- Dominion Artillery Association, annual meeting of, at Ottawa.—Feb. 21.
- Dominion Rifle Association, Ottawa, annual meeting and election of Officers.—Feb. 20.
- Duels, France, Poet Catulle Mendes fights the writer Le Blanc at Paris.—Feb. 9.
- Duels, France, Deputies Laguerre and Lacroix, fight at Paris.—Feb. 3.
- Duel, Paris, Rochefort M., challenges M. Pilotelle, famous French artist, living in London.—Feb. 16.
- Dynamite, France, Chantres, Three post office officials injured by explosion of letter box.—Feb. 15.
- Earthquake, Grand Metis, Que., slight shock felt at.—Feb. 5.
- Earthquake, Edmonton, N. W. T., stock of, felt at.—Feb. 12.
- Earthquake, Marion, Ind., slight shock felt at.—Feb. 26.
- Earthquake, Naples shock of, Vesuvius in action.—Feb. 11.
- Earthquake, Bolton and Manchester, England, shock of, felt at.—Feb. 11.
- Earthquake, San Jacinto, San Diego Co., Cal., severe shock at.—Feb. 8.
- East Africa, bill adopted by German Bundesrath.—Feb. 2.
- ECCLESIASTICAL.—Chicago, Rev. George Charles Street, Canon of Cathedral of St. Peter and St. Paul, dies in Florida.—Feb. 3.
- Cardinal John Baptiste Pitra, death of.—Feb. 11.
- Cardinal Charles Saccconi, death of.—Feb. 25.
- Dollinger Dr., originator of Old Catholic movement, banquetted at Munich.—Feb. 28.
- Dublin, Archbishop Walsh speaks to pupils of Catholic school on the position of Irish Catholic Colleges.—Feb. 19.
- Elmira, N. Y., death of Very Rev. Dean Thomas Cunningham, Dean of St. Peter and St. Paul's church.—Feb. 4.
- England, presentation of Bishop of Lincoln, Lord Carnarvon signifies his intention of appeal to House of Lords to stop prosecution.—Feb. 23.
- Georgetown, Jesuits University celebrates its centennial.—Feb. 23.
- Greece, death of Monsignor Prokopios, primate, at Athens.—Feb. 11.
- Hamilton, appointment of Bishop Dewling of Peterboro to diocese of Hamilton ratified.—Feb. 12.
- Hamilton, deputation from church of England defence Association waits upon Bishop of Niagara, with reference to Ritualistic practices.—Feb. 2.
- McGlynn Dr., at New York, denounces the church for permitting burial of Crown Prince Rudolf with all honors.—Feb. 10.
- Merrick Rev. Joseph, death of, at Winnipeg.—Feb. 24.
- Mississippi, Mayor R. W. Millsap, president of Capital State Bank, Jackson, Miss., subscribes \$50,000 to build and endow college for Methodist Episcopal church.—Feb. 14.
- McZeire Rev. H. N., senior bishop of Methodist Episcopal church south, death of, at Nashville, Tenn.—Feb. 15.
- Newman Cardinal, observes 88th anniversary of his birth by celebrating pontifical high mass in London.—Feb. 21.
- New York, Catholic pilgrimage to Holy Land sails on the "Wieland."—Feb. 21.

## ECCLIASTICAL.—Continued.

Ohio, Bishop Heddoe, of stricken with paralysis at Nice.—Feb. 19.  
 Ontario, Bishop of, married to Miss Ada Leigh, at Paris, France.—Feb. 20.  
 Ottawa, meeting of Catholics, express sympathy with the Pope, and demand restoration of the temporal power.—Feb. 24.  
 Peterboro, Dean O'Connor, of Barrie, appointed Bishop of.—Feb. 13.  
 Rome, at consistory, Monsignor Stonor appointed Archbishop of Trebrizoni.—Feb. 11.  
 Rome, Pope at the consistory nominates for the cardinalate Monsignors Macchi and Dambrato and the Archbishop of Catania.—Feb. 11.  
 Rome, papal allocution on the position of the church in the modern world.—Feb. 13.  
 Rome, Pope and consistory preconizes new bishops of Detroit, Natchez and Wichita, Kansas.—Feb. 14.  
 Rome, Pope receives letter of sympathy in his trials from United States bishop.—Feb. 15.  
 Rome, General of Augustinian order, death of.—Feb. 25.  
 Scotland, Church of, Earl of Hopetown appointed Lord High Commissioner of.—Feb. 26.  
 Toronto, judgment in the case of Rev. T. W. Jeffery, late Pastor of Western Methodist Church, handed out.—Feb. 28.  
 Toronto, death of Rev. James Stewart, senior Presbyterian minister, in Canada.—Feb. 20.  
 Trial of the Right Rev. Bishop King of Lincoln, England, for Ritualism.—Feb. 12.  
 Truro, N. S., golden jubilee of Rev. Dr. McCullough as pastor of First Presbyterian church celebrated.—Feb. 14.  
 United States, Methodist church, Book Committee increases the salary of bishops of foreign missions.—Feb. 14.  
 Cardinal Levoelowski, formerly primate of Poland and Archbishop of Posen, death of.—Feb. 7.  
 Egypt, Soukim, Governor of, with cavalry escort, visits Handoub, and finds camp of 5000 huts hurriedly evacuated.—Feb. 16.  
 Egypt, Italian Government obtains from Sultan concession of Kismarza and ports to the Northward.—Feb. 17.  
 Egypt, Emin Pasha vanquishes Dervishes in Bah-el-Gazel provinces reported by deserter from Wady Halfa.—Feb. 27.  
 ELECTIONS.—France, Var, election of General Cluseret confined by Chamber of Deputies.—Feb. 5.  
 Albert County, N. B., nomination of candidates for local legislature.—Feb. 16.  
 Albert County, N. B., Emerson, Ministerialist elected for local house.—Feb. 23.  
 Burnley, England, Spencer Balfour, Gladstonian, elected to House of Commons.—Feb. 27.  
 Cardwell, application made to Queen's Bench, Toronto, for an order substituting name of Samuel Stubbs for that of Mr. Smith on the record protesting against Mr. White's return.—Feb. 9.  
 Ogden, Utah, municipal elections, Gentiles successful over the Mormons.—Feb. 11.  
 Hallimand, meeting of conservatives held in Hagersville resolves to protest election of.—Feb. 7.  
 London, Eng., election of Aldermen by the new council, a lady elected.—Feb. 5.  
 Pulaski County, representatives of, resign in Arkansas legislature, and committee on elections submit report in favor of seating the contestants.—Feb. 18.  
 Scotland, Perthshire, Kinloch, Gladstonian candidate, defeats Boaz, Unionist.—Feb. 19.  
 Electric light patents, those of Edison and Swan upheld against the Holland and Anglo-American patents, by decision of Court of Appeal, London, Eng.—Feb. 18.  
 Electric, National Electric Light Association, meeting of, at Chicago.—Feb. 22.  
 Elopements, Cleveland, Ohio, Cary Rollin, Advertising Agent of Lake Shore & Michigan Southern railroad, and wife of T. J. Meaba, assistant labor statistician, and manager of the *Industrial News*.—Feb. 22.  
 Elopements, St. Paul, Minn., Oakes Ames, cousin of Governor of Massachusetts, elopes with, and marries Emma Watson, assistant postmistress of St. Anthony Park.—Feb. 1.  
 Emigration, South America, 68 steamers in January take 25,000 emigrant to Buenos Ayres, official returns issued.—Feb. 11.  
 Emin Bey, letter received at Zanibar from Mr. Mackay, missionary at Usamboro, dated Nov. 26th, stating no direct news of, received.—Feb. 4.  
 Greek arrives at Cairo from Khartoum, and reports that Senasso has taken El Obeid.—Feb. 9.  
 Evansville, Md., Heidel George, disguises himself as a ghost, killed by Tompkins, a negro.—Feb. 1.  
 Evictions, Hlawarden Estate, Mr. W. H. Gladstone explains.—Feb. 14.

Explosions, New York, explosion on New York, New Haven and Hartford railroad between Williams Bridge and Hedford Park, 500 persons injured.—Feb. 11.  
 Express rates, New York, agreement signed by presidents of several companies re-establishing the rates existing in all competitive business prior to May 31, 1886.—Feb. 1.  
 FAILURES, (Hamilton, Ont., Vallancey E. Fuller, liabilities nearly \$1,000,000.—Feb. 2.  
 Birks County, Pa., Sheriff sells ten fine farms.—Feb. 8.  
 Boston, Glidden & Curtis, selling agents of Pacific Guano Company.—Feb. 8.  
 Hamilton, Ont., Fuller Vallancey E.—Feb. 5.  
 Indianapolis, Ind., Sullivan John E., County Clerk.—Feb. 1.  
 London, Ont., Speaker Printing Co., ordered to be wound up.—Feb. 7.  
 Morris, Man., creditors of the town refuse to come to terms.—Feb. 15.  
 New York, Hatch Edward, member of Stock Exchange.—Feb. 16.  
 New York, Wyatt C. A., woollen merchant.—Feb. 16.  
 Ohio and Western Coal and Iron Com any.—Feb. 9.  
 Ohio and Western Railroad assigns.—Feb. 11.  
 Rome, Marquis Theodule.—Feb. 4.  
 Toronto, Biale and Kerrigan statement of affairs presented.—Feb. 13.  
 Virginia, Bank of Bedford.—Feb. 12.  
 Woods, Hall, Mass., Great Pacific Guano Company.—Feb. 8.  
 Farmers, Central Institute of, Ontario, open session at Toronto.—Feb. 5.  
 Farmers, Central Farmers Institute, Toronto, Prof. Saunders lectures on agricultural matters.—Feb. 6.  
 Farmers, Central Farmers Institute of Ontario passes resolution that Government grant to Provincial exhibition should cease.—Feb. 7.  
 Farming, Birks County, Pa., sheriff sells ten fine farms.—Feb. 8.  
 Fertilizers artificial, duty on, discussed in Canadian House of Commons.—Feb. 12.  
 Fisk Mary H., writer, and wife of Stephen Fisk, litterateur, death of, at New York.—Feb. 4.  
 Flood James C., Bonanza King, of California, death of, at Heideburg.—Feb. 21.  
 Fort Saskatchewan, N. W. T., meeting held at, in connection with Railway terminus of Alberta and Athabasca Ry. Company.—Feb. 4.  
 FRANCE, Boulanger General, writes to Paul de Roulede, president of the Patriotic league, upon share it took in recent election.—Feb. 3.  
 Atchinnoff incident, official explanation from French Government.—Feb. 27.  
 Boulanger applies to the Pope for a divorce on the ground that his marriage was irregular.—Feb. 5.  
 Boulanger General, in an interview at Paris favors the establishment of a constitution similar to that of United States.—Feb. 11.  
 Boulanger General, interviewed in Paris says if he came into, he could induce England to evacuate Egypt, and thus remove the only difficulty between France and England.—Feb. 12.  
 Boulanger, General, M. Florens states that Boulanger's attitude at the time of the Schmaemel excitement in 1887 left nothing to be desired.—Feb. 11.  
 Boulanger Gen., mind reader, reads his thoughts.—Feb. 25.  
 Boulanger Gen., speaks on Atchinnoff incident, at soiree of artists and authors.—Feb. 28.  
 Chamber of Deputies, freedom and secrecy of the ballot, bill passed for.—Feb. 25.  
 Chamber of Deputies, The *scrutin d'arrondissement* bill tabled.—Feb. 1.  
 Chamber of Deputies, *scrutin d'arrondissement* bill, motion demanding urgency for, defeated.—Feb. 2.  
 Chamber of Deputies, election of General Cluseret as member for Var, confirmed.—Feb. 5.  
 Chamber of Deputies, Numa Gilly, proceedings against, for libelling Budget Committee, government questioned regarding delay.—Feb. 7.  
 Chamber of Deputies, grant priority to *scrutin d'arrondissement* bill, and decide to consider the bill for the revision of the constitution on Thursday.—Feb. 9.  
 Chamber of Deputies, Budget estimates presented by Minister of Finance.—Feb. 11.  
 Chamber of Deputies, *scrutin d'arrondissement* bill passed.—Feb. 11.  
 Chamber of Deputies approves an additional convention relative to the exchange of postal orders between France and United States.—Feb. 11.  
 Chamber of Deputies, The revision of the constitution, the government defeated.—Feb. 14.  
 Chamber of Deputies, Bill proposing to add to the expulsion of 1886 clause, assimilating to princes any person trying to compass the restoration of personal or dictatorial power for his own benefit, presented by Mr. Rondieux.—Feb. 26.

## FRANCE.—Continued.

- Chamber of Deputies, motion of Mr. Laffon to prevent candidate for chamber from simultaneously contesting two seats, discussed and referred to a committee.—Feb. 27.
- Chamber of Deputies. Atchinnoff incident, M. Spuller, minister of Foreign affairs, declines to discuss same.—Feb. 28.
- Chamber of Deputies. Tonquin question, Mr. Andrieux's motion attacking the cabinet on defeated.—Feb. 28.
- Chartres, three post office officials injured by explosion of dynamite in letter box.—Feb. 15.
- Grey ex-president, serious illness of.—Feb. 20.
- Senate committee of, discusses measure providing that persons publishing slanderous personal statements shall be summarily dealt with by the correctional tribunal.—Feb. 11.
- Senate, *Scrutin d'arrondissement* bill adopted.—Feb. 13.
- Chateau Chanouzeaux, owned by sister of M. Wilson, sold to Credit-Foncier.—Feb. 2.
- Duel, deputies Laguerre and Lacroix fight at Paris.—Feb. 3.
- Duels, Poet Catulle Mendes fights the writer Le Blanc at Paris.—Feb. 9.
- M. Ferrouillat, Minister of Justice, resigns.—Feb. 4.
- M. de Freycinet confers with General Boulanger, and it is said offered him a seat in the future Cabinet.—Feb. 4.
- Members of Ministry send in their resignation to President Carnot.—Feb. 14.
- M. Meune abandons the task of forming a cabinet, and President Carnot appeals to M. Rouvier to form a ministry.—Feb. 16.
- Ministerial crisis, Radical manifesto issued devoted chiefly to denouncing General Boulanger.—Feb. 18.
- M. Dr. Freycinet declines to join M. Meline's Cabinet.—Feb. 18.
- M. Meline endeavoring to form a cabinet.—Feb. 18.
- Ministry, M. de Freycinet summoned by President Carnot to form a cabinet.—Feb. 20.
- Ministry, Dr. Freycinet and Meline interview the president and endeavor to form a combinative cabinet.—Feb. 21.
- Ministry, President Carnot signs decree appointing new minister.—Feb. 21.
- New Cabinet, formation of.—Feb. 21.
- Minister of War issues circular reminding French Officers and soldiers that political demonstrations by troops are forbidden.—Feb. 9.
- Paris, rise of the Seine floods the suburbs.—Feb. 12.
- Paris Count of, instructs Count Dillon to sit with central conservative committee.—Feb. 28.
- Patriotic League, Paris, resolves to protest against France's treatment of Atchinnoff expedition.—Feb. 27.
- Patriotic League, Paul de Ranelde, president, and other leaders, arrested for signing Atchinnoff manifesto.—Feb. 28.
- Patriotic League. The committee meet in Paris, and protest against action of the Government.—Feb. 28.
- Radial ante-Boulanger declaration. Deputies Andrieux and Steenackers decline to sign.—Feb. 26.
- Paris, Socialists attempt to hold meeting in the Place Hotel de Ville, Paris, a number arrested.—Feb. 24.
- Relations between president Carnot and Lord Lytton, British Ambassador, become strained on a point of etiquette.—Feb. 18.
- Senate bill passed providing that press offences be dealt with by correctional police tribunals.—Feb. 15.
- Senate, Bill for construction of two cruisers approved.—Feb. 28.
- Senate and Chamber of deputies ministerial declaration read in.—Feb. 23.
- Socialist revolutionary societies, delegates present resolutions adopted at the workmen's conference at Bordeaux to Premier Floquet and other ministers.—Feb. 10.
- Guyot, Dessaigne] succeeds M. Ferrouillat as Minister of Justice.—Feb. 5.
- Rin General, placed under arrest for making speech against the government.—Feb. 5.
- Captain Trevier, French Naval officer, organizing expedition for purpose of solving some unsettled problems as to Lake Zanganzika, Africa.—Feb. 4.
- Colonel Zeanart's order commenting on action of German authorities in refusing passport to French Army Surgeon to go to Strasbourg to see dying mother, receives attention of Minister of War who orders commander-in-chief to report on the matter.—Feb. 7.
- Free Land League, Joseph Chamberlain, M.P., resigns from.—Feb. 25.
- Friedrichs Gustave A., editor of *Pittsburg Vaiklatt* death of, at New York.—Feb. 2.
- Frontenac, Archibald McGill appointed clerk of Crown for.—Feb. 19.
- Fruit growers, British Columbia Association of, formed at Vancouver, B. C.—Feb. 2.
- Funeral Directors Association for Province of Quebec, Annual Meeting at Montreal.—Feb. 7.
- Celician miners employed in Silesian coal pits ordered to quit the country.—Feb. 22.
- Gaolers, Ontario, Congress of, at Toronto.—Feb. 20.
- Gas natural, Collingwood, Ont., escapes from baptistry in Baptist Church.—Feb. 25.
- GERMANY, article in contemporary review on the Bismarcks forbidden to be published in Germany.—Feb. 1.
- Banking, *Boersen Zeitung* gives figures showing the rapid growth of banking business since 1865.—Feb. 4.
- Bersford Lord Charles, dines at Berlin with the Emperor and Empress.—Feb. 6.
- Berlin, Wissman Capt., leaves for East Africa.—Feb. 15.
- Berlin stock exchange, dealings in Bulgarian bonds forbidden on.—Feb. 26.
- Bismarcks feud with ultra-conservatives. Search ordered of offices of *Krenz Zeitung* for manuscript of article on chancellors conduct of Gelfcken enquiry.—Feb. 2.
- Bundesrath adopts East African bill.—Feb. 2.
- Bundesrath. Army expenditure, Bill introduced providing for raising loan of 12,492,304, marks to meet supplementary estimate.—Feb. 28.
- Empress Frederick leaves England for.—Feb. 26.
- Gelfcken Prof., publication of indictment against, debate in the Reichstag thereon.—Feb. 5.
- Gelfcken Prof., institutes action against Imperial prosecutor for violation of secrecy in private correspondence.—Feb. 16.
- Hanover, Province of, Count William Bismarck appointed president of.—Feb. 7.
- Max Bernstein, candidate for office of rabbi, sentenced to three months imprisonment for drawing blood from christian boy.—Feb. 22.
- Munich, proceedings in Municipal Council as to congratulating Dr. Dullinger, leader of old Catholics, on his 90th birthday.—Feb. 22.
- Prussian diet votes addition to Emperor's civil list.—Feb. 16.
- Reichstag, Samon, White book in reference to, introduced.—Feb. 16.
- Prussian diet, Emperor's civil list bill passes its second reading.—Feb. 9.
- Emperor William officially notifies Prince Alexander of Battenberg that he does not desire his presence in Berlin.—Feb. 11.
- English cartoon representing Prince Bismarck as Goliath assailed by the press as David, seized by German authorities.—Feb. 11.
- Reichstag, bill introduced providing for loan of sixty million marks for army, navy and state railways.—Feb. 2.
- Reichstag, Budget, third reading of.—Feb. 5.
- Samon Consul to be removed for exceeding his instructions.—Feb. 5.
- Glace Bay Mining Association, annual meeting of, at Halifax, N. S.—Feb. 4.
- Gladstone Mr. W. E., the Pope, Signor Crispi brings his influence to help Mr. Gladstone alter his determination as to calling upon the Pope.—Feb. 7.
- Gladstone Mr. W. E., arrival of, at Folkestone, he speaks on the Parnell Times commission.—Feb. 20.
- Gladstone Mr., writes to *The Times* as to the evictions at Hawarden.—Feb. 25.
- Gladstone Mr. W. H., explains as to evictions on Hawarden Estate.—Feb. 14.
- Glasgow, Scotland, conference of liberal and radical Unionists, speech by Mr. Chamberlain.—Feb. 13.
- Gold finds, Lower California. Special from Esazurda to San Francisco reports discoveries.—Feb. 26.
- Gold, Sib, discovered by a peasant near Irkutsk.—Feb. 28.
- Grain frosts for seed. Prof. Green, of State Agricultural College, St. Paul, Minn., completes his report thereon.—Feb. 24.
- Grain Examiners, Canada, pass resolution at meeting at Winnipeg, asking Dominion Government to establish separate board for Manitoba and Northwest to fix grain standards.—Feb. 15.
- Granite quarry, Graniteville, Mo. Five tons of powder exploded in Schneider quarry.—Feb. 24.
- Greece, death of Moosisgour Prokopius, primate of Greece.—Feb. 1.
- Guns powder, high railway rates, hardware section of Toronto Board of Trade waits upon freight manager of Grand Trunk Railway as to.—Feb. 12.
- Guo dynamite, United States secretary of war awards contract for to Pneumatic Dynamite Gun Company of New York.—Feb. 7.
- Half-breeds, St. John, Dakota, collection of taxes resisted, the Militia called out.—Feb. 15.
- Hamilton, Ont., Wentworth Pioneer and Historical Society hold their meeting, and adopt constitution.—Feb. 7.
- Harcourt Sir William Vernon, in speech at Derby, refers to proceedings of Round Table conference.—Feb. 27.
- Hartford, Conn., Park Central Hotel falls down through boiler explosion fifty persons buried.—Feb. 18.

Hartford, Conn., Thuer Alexander, engineer of wrecked Park Central Hotel, arrested for manslaughter.—Feb. 18.

Hartington Marquis of, speaks on Irish matters at Norwich, England.—Feb. 27.

Hawarden evictions. Gladstone Mr., writes to *The Times* as to.—Feb. 25.

HAYTI.—News received at Paris legation that troops of Legitime have defeated Hippolyte's forces, and that towns have surrendered.—Feb. 4.

French Envoy ordered to present his credentials to Legitime.—Feb. 5. Contreras (G.), disappears from Haytian consulate, New York, and is suspected as sailing on the "Caroudelet," carrying cargo of arms for Hippolyte.—Feb. 18.

Hippolyte's forces completely routed, between 200 and 300 men killed Feb. 9, reported Feb. 21.

Steamer "Madrid" bought for General Hippolyte, returns to Lower Bay, and is seized by United States authorities.—Feb. 19.

Hayti, assassination of Hippolyte by insurgents, report of, brought by officer of steamer "Victoria" at New York from San Domingo.—Feb. 27.

Heller Michael, Snake bite doctor, dies at Reading, Pa.—Feb. 4.

Hessian fly destroying wheat crop in Central Illinois.—Feb. 11.

Hirsch Baron, donates 120,000 francs yearly to Austria and to Hungary, for relief of tradesmen in danger of financial ruin.—Feb. 27.

Holland, King of, has a relapse.—Feb. 18.

Horses, San Francisco, sale of stallion Stamboul and broodmare "Sweet-heart," "Hobon Bon" and "Astrin" to W. S. Hobart.—Feb. 22.

Hudson Bay Company, Mr. Walter Vaughan Morgan elected director.—Feb. 7.

Hudson River, Poultry, Dog and Pet Stock Association, first show opens at Newburgh, N.Y.—Feb. 7.

Hungary, Duboka, epidemic of typhus fever at.—Feb. 8.

Hungary, army bill, Pesth, students make another riotous protest against.—Feb. 12.

Hungary, Diet, army bill considered amid wild disorder.—Feb. 15.

Hungary, Military bill, great demonstration against, at Pesth.—Feb. 17.

Hungary, Diet, Army bill, Premier Von Tizza speaks in defence of, amid a stormy scene.—Feb. 28.

Hunt Col. Henry J., Governor of the Soldiers home in the district of Columbia, death of.—Feb. 11.

Hydrophobia, Portsmouth, R.I., daughter of Rev. G. H. Patterson dies from.—Feb. 24.

Illinois House, Baseball on Sunday, bill introduced prohibiting.—Feb. 15.

Imperial Federation, Peterboro, Ont., meeting addressed by Mr. Dalton McCarthy, M.P.—Feb. 16.

Imperial Federation, Montreal, lecture by Mr. Parkin, of Fredericton, N.B.—Feb. 21.

Imperial Federation, Kingston, Ont., League founded at.—Feb. 23.

Imperial Institute, England, accounts published for 1898 show a deficit of 212,335, fresh subsidies being sought in India.—Feb. 14.

IMPERIAL PARLIAMENT.—Mr. W. H. Smith, Government leader, issues circular to his porters, urging attendance at opening of Parliament.—Feb. 11.

Re-assembling of, Queen's speech.—Feb. 21.

Irish policy of the Government, Mr. John Morley gives notice of motion of censure.—Feb. 21.

House of Commons, Mr. Parnell draws attention to treatment of Mr. Carew in prison, Mr. Balfour's defence.—Feb. 22.

House of Commons, Morley Mr., moves amendment to the address, condemning the administration in Ireland.—Feb. 25.

House of Commons, Parnell case, Home Secretary states that authorities were taking steps to secure extradition of Pigott from Paris.—Feb. 27.

House of Commons, Mr. Healy gives notice of want of confidence in the Attorney General.—The Irish debate resumed.—Feb. 28.

INDIA.—Dhuleep Singh sends a proclamation inviting the people to throw off the English yoke.—Feb. 12.

Indian troubles, Montana, Flat heads Indian arming themselves, settlers in Flat Head Lake valley in danger.—Feb. 19.

Indianapolis, Ind., Dudley Col. W. V., of the Republican national committee, warrant for arrest of issued.—Feb. 23.

Insanity, McAlisterville, epidemic of, at Soldiers' Orphans School.—Feb. 7.

Insanity, Baltimore, Lee Wiele, a young man from Virginia, attacks Francis Valentine, an old man, and kills him.—Feb. 5.

Insanity, Middleton, N. Y., John Powers, aged 11, becomes a maniac from the effects of cigarette smoking.—Feb. 12.

IRELAND.—arrest of Father McFadden, Father Covey speaks at Skibberen upon the death of Inspector Martin, and prays God to strengthen the hand that murdered him.—Feb. 6.

Carew James Lawrence, M.P. for North Kildare, arrested in Eastern Division of Perthshire, for refusing to answer a summons for violating the Crimes Act.—Feb. 19.

## IRELAND.—Continued.

Carew Mr., M.P., sentenced to four months imprisonment for violating Crimes Act.—Feb. 21.

Castle Connell, Father Marram sentenced to imprisonment for offences against Crimes Act.—Feb. 2.

Condon Mr. Thomas, M.P., sentenced to imprisonment for inciting boycotting.—Feb. 7.

Crimes Act, Mr. John Morley speaks on, at Newcastle, Eng.—Feb. 4.

Downpatrick, carlines stolen from arnary.—Feb. 7.

Dublin, Kilbride Mr., M.P., sentenced to imprisonment for breach of Crimes Act.—Feb. 8.

Dublin, Matt Harris at meeting of National League in Dublin refutes Le Caran's evidence, and condemns assassins.—Feb. 13.

Dublin, corporation adjourns without transacting business as mark of sympathy with Mr. O'Brien.—Feb. 4.

Dublin Court of Appeal refuses to grant order of appeal to William O'Brien, against recent sentence of four months imprisonment.—Feb. 16.

Dublin, Archbishop Walsh speaks on the position of Irish Catholic Colleges.—Feb. 9.

Dublin, Father Stephens, arraigned for advising tenants on Olypher estate not to pay their rents.—Feb. 25.

Donegal, O'Kelleys James, M.P., sentenced to imprisonment for inciting tenants to adopt plan of campaign.—Feb. 12.

Edinburgh, meeting at, letter read from Mr. Gladstone, protesting against treatment of Mr. O'Brien and others.—Feb. 20.

Ennis, two constables arrested for moonlighting and mutilating cattle.—Feb. 7.

Gweedore, murder of Police Inspector Martin, seven more arrests made.—Feb. 13.

Gweedore, police inspector Martin killed while trying to arrest Father McFadden.—Feb. 3.

Gweedore, Father Stephens arrested for advising Olypher tenants not to pay rent.—Feb. 24.

Hartington Marquis of, speaks on, at Norwich, England.—Feb. 27.

Home Rule, Dundee, meeting in favor of, attended by 29,000 persons.—Feb. 14.

Home Rule for, resolution in favor of, notice given in Canadian House of Commons.—Feb. 19.

Kilkenny, riot on arrival of Mr. Carew, M.P., several persons injured.—Feb. 21.

Kilkenny gaol, hair and beard of Mr. J. L. Carew, M.P., forcibly removed.—Feb. 22.

Killing of Inspector Martin, Irish Patriotic Union, issues political circular upon.—Feb. 25.

Kenmare estate, summons served on Mr. O'Brien in Clonmel gaol for illegal speeches on.—Feb. 7.

Kilbride Dennis, M.P., arrested at Leicester, for violating Crimes Act.—Feb. 4.

Letterkenny, Father McFadden taken to, the military charge the crowd.—Feb. 4.

Limerick, John Finucane, M.P., and others, imprisoned for offences under Crimes Act, released, meeting held in their honor.—Feb. 3.

McFadden Father, removed from Gweedore to Londonderry gaol.—Feb. 9.

Members send cablegram appeal for funds to Irish national league of America.—Feb. 19.

Mr. Morley, in British House of Commons, moves amendment to the address condemning administration in.—Feb. 25.

O'Brien, governor of prison informs Mr. O'Brien, he will compel him to do prison uniform, and in case he refuses food, will administer it artificially.—Feb. 1.

O'Brien declares he will not wear the prison garb.—Feb. 1.

O'Brien, protests by Lord Mayor of Dublin and others against prison treatment of.—Feb. 1.

O'Brien treatment of, mass meeting in Phoenix Park, Dublin, under presidency of Lord Mayor, denounces.—Feb. 2.

O'Brien ordered nourishing food by medical inspector.—Feb. 4.

O'Brien's clothing returned to him by prison officials.—Feb. 5.

O'Brien, Habeas Corpus granted for William O'Brien at Dublin, in order that he may be arraigned in Kildare Court.—Feb. 8.

O'Brien, treatment of, Mr. Balfour defends him—in long reply to a correspondent.—Feb. 10.

O'Brien, Mass meeting held in Hyde Park, London, to express sympathy with.—Feb. 19.

O'Brien and Balfour. The latter defends himself in letter to *The Times*.—Feb. 11.

O'Brien conveyed from Clonmel to Tralee. Escort attacked with stones at Clonmel.—Feb. 11.

O'Brien William, arraigned on summons issued against him for violating the Crimes Act.—Feb. 12.

O'Brien W., M.P., arraigned for offences under Crimes Act, Mr. Healy expelled from the Court.—Feb. 18.



## IRELAND.—Continued.

O'Brien's case resumed, and he is sentenced to six months imprisonment.—Feb. 19.

O'Brien Wm., removed to Galway gaol, an excited crowd witness his departure.—Feb. 21.

Policy of British government denounced in resolutions by Celtic Benefit Association of Ottawa.—Feb. 27.

Proceedings at round table conference referred to by Sir W. Vernon Harcourt in speech at Derby.—Feb. 27.

Sheehy Mr., M.P., appeals against sentence for making speeches at Dallyneety.—Feb. 1.

Tipperary, rioting in, 29 civilians and 12 police injured.—Feb. 1.

Wicklow, Father Clarke arrested for making speeches tending to excite the people to unlawful acts.—Feb. 25.

Irish American Societies, Chicago, decide after a hot debate to have a St. Patrick's day parade this year.—Feb. 17.

Iron Manufacturers, Canadian, deputation of, waits on Minister of Finance to have duty on malleable scrap iron increased.—Feb. 22.

ITALY.—Chamber, Italian spy named Schmidt arrested with plans of Italian front.—Feb. 6.

Budget Committee, Giolitti declares if Italy desires to maintain her military strength it will be necessary to increase budget by forty million francs.—Feb. 23.

Chamber of Deputies, Budget announcement.—Feb. 2.

Chamber of Deputies, Prime Minister Crispien scoffs at the Peace Society.—Feb. 5.

Milan, Radicals attempt to celebrate the revolt of 1853.—Feb. 10.

Rome, collisions between police and unemployed working men.—Feb. 8.

Prime Minister Crispien resigns.—Feb. 28.

Nice, Battle of flowers, Prince of Wales present at.—Feb. 28.

Rome, agitation in, Premier Crispien complains to Premier Bismarck that prominent German Socialists consorted with Frenchmen in causing the agitation.—Feb. 16.

Jersey City, Montgomery street caves in.—Feb. 4.

Japan constitution of the Empire proclaimed by the Emperor in person.—Feb. 11.

Japan, Tokio, Viscount Arimori Mori, Minister of Education, assassinated by a fanatic.—Feb. 14.

Japan and United States, supplementary treaty of commerce, amity and navigation between, signed.—Feb. 20.

Jesuits University, Georgetown, celebrates its centennial.—Feb. 23.

Journalism, Leslie Mrs. Frank, sells to W. J. Arkell her proprietary interest in her English and German illustrated papers.—Feb. 23.

Journalism, Winnipeg Free Press purchases the Morning Call.—Feb. 9.

Journalism, London, Eng., protest against the publication of New York Herald's Sunday edition.—Feb. 6.

Kansas Legislature, Petition from National Anti Horse-Thief Association, prays for enactment of law to authorize lynchings of horse thieves.—Feb. 8.

Kansas State Senate passes bill to prevent trusts, combinations and pools.—Feb. 27.

Kent, Ohio, serious riot between laborers engaged in grading new connection between the Pittsburg and Western and the Cleveland and Canton Railroads.—Feb. 24.

Kiel, storm at, causes much damage to shipping, and partially floods the town.—Feb. 24.

Kingston, Ont., Petition presented to City Council signed by 1214 representative citizens, asking reduction in number of liquor licenses, discourteously treated by aldermen.—Feb. 11.

Kingston, Ont., street car shed collapses.—Feb. 17.

Klein John C., American newspaper correspondent, charged with leading the natives of Samoa against the Germans, arrives at San Francisco.—Feb. 16.

Labor, New York, recent strike of street car employes, circular issued by advanced champions of labor, as to bribe takers and traitors.—Feb. 15.

Labor associations, Philadelphia, important conference of leaders at.—Feb. 14.

Labor Commission, Ottawa, insurance question discussed at sitting.—Feb. 2.

Labor Knights of, and boot and shoemakers' movement in Boston to sever the connection between.—Feb. 28.

La Porte County, Mo., twenty persons attacked with trichinosis.—Feb. 26.

Lattimer Sarah J., philanthropist, death of, at Plainfield, N.J.—Feb. 3.

Leather, boot and shoe men of Montreal go to Ottawa to protest against change in duty on fine leathers.—Feb. 11.

Leeward Islands, Society Group, French authorities express their intention of taking possession of, but are met with determined opposition by natives.—Feb. 19.

LEGAL.—France, tribunal in Paris decides adversely to demand of petitioners of old Panama Canal Company for dissolution.—Feb. 4.

England, Jos. Dodds, barrister, formerly M. P. for Stockton on Tees disbarred for embezzlement.—Feb. 19.

Halifax, Boston, Halifax and Prince Edward Island Steamship Co. brings action for libel against Halifax Herald Publishing Co.—Feb. 15.

Iowa State, Supreme Court decides that importations and sale of liquors in original packages contrary to law.—Feb. 7.

Ireland, Dublin Court of Appeal refuses to grant order of appeal to Wm. O'Brien against recent sentence to four months' imprisonment.—Feb. 16.

Kingston, Ont., Monthes, Joel F., seed wheat dealer, arrested at Renfrew, for transactions with farmers, enters an action for \$10,000 against Police Magistrate Eady.—Feb. 16.

Logan, Ohio, Boston Safe Deposit and Trust Company files petition in Court, praying foreclosure of mortgage on property of Ohio Western Coal and Iron Company.—Feb. 13.

London, England, Electric Light patents, Edison and Swan's patents upheld against the Holland and Anglo-American British patents.—Feb. 18.

New York, Court of claims gives judgment in favor of Central Pacific Railway in its suits against the United States for withholding dividends.—Feb. 18.

New York, Cleveland President, associates himself with law firm.—Feb. 4.

Ottawa, Manitoba Mortgage Company vs. Bank of Montreal, judgment delivered in the Supreme Court.—Feb. 8.

Paris, Panama Canal Company decided by Tribunal of Commerce to be Commercial Company.—Feb. 18.

Quebec, Appeal Court, Salvation Army case, reserved points, and motion for new trial argued.—Feb. 1.

Toronto, Cardwell election, application made to Queen's Bench for Order substituting name of Samuel Stubbs for that of Mr. Smith, on record protesting against Mr. White's return.—Feb. 9.

Toronto, case of the Queen versus the Corporation of City of London, Ont., decided.—Feb. 4.

Toronto, case of J. Baldwin Hands versus Law Society of Upper Canada, decided.—Feb. 4.

Washington, death of Judge William Merrick, of Supreme Court of District of Columbia.—Feb. 4.

Leases M., illness of, at Paris.—Feb. 12.

Label, Chicago, Inspector Bonfield and Captain Schnack sue The Times for \$1,500,000 damages for charging them with corruption, upon which they are suspended.—Feb. 6.

LITERARY.—Clement Scott, dramatic critic, left legacy of £10,000 by Miss Drew.—Feb. 14.

Liquors, Iowa State, Supreme Court decides importation and sale of, in original packages, contrary to law.—Feb. 7.

London County Council, election of officers.—Feb. 13.

London, Ont., annual report of School Board.—Feb. 6.

London, Ont., The Queen versus Corporation of, case decided at Toronto.—Feb. 4.

London, Ont., school board for 1889 organized.—Feb. 6.

Londonderry Iron Company, annual meeting at Montreal.—Feb. 13.

Longworthy Dr. H. H., death of, at Rochester, N.Y.—Feb. 5.

Lorway Capt. Charles M., commander of Canadian fishery cruiser, death of, at Sydney, C.B.—Feb. 18.

Lotteries, Missouri, People vote on constitutional amendment giving legislature power to establish.—Feb. 11.

Lumbermen, Canada, deputation waits on Government to have extra duty of \$2 per standard on Canadian cut logs exported to the States removed.—Feb. 21.

Lumbermen, Ontario Lumbermen's Association meets at Toronto, and passes resolution protesting against export duty on logs.—Feb. 7.

Mackenzie Hector, an old officer who accompanied Dr. Rae on the Franklin expedition, death of, at Winnipeg.—Feb. 1.

MANITOBA.—Legislature, bill introduced respecting real estate in Winnipeg, which will decentralize the Torrens system.—Feb. 1.

Legislature, bill providing for railway crossings receives second reading.—Feb. 4.

Legislature, Railway bill and probate bill passes.—Feb. 6.

Legislature, real property act read first time.—Feb. 7.

Legislature, real property Act passes its second reading.—Feb. 12.

Legislature, agreement between Northern Pacific and Manitoba railroads, bill embodying same introduced.—Feb. 14.

Legislature, Attorney General states that government will assist any municipality which enters suit against Canada North West Land Company for payment of taxes due. Brandon and South Western Railway incorporation bill read third time.—Feb. 26.

Legislature, Budget speech by treasurer Jones, estimates submitted.—Feb. 25.

Northern Pacific and Manitoba railways, bill relating to, amended contract read third time.—Feb. 20.

## THE INDEX OF CURRENT EVENTS.

- Marion, Ills., riots and race war in consequence of employment of colored men at Westbrook's tobacco factory.—Feb. 5.
- MARRIAGES.**—India, Tilley Lieut. W. T. R. P., son of Sir Leonard, Tilley, to Miss Lena Amesbury, daughter of surgeon of the brigade.—Nov. 21, reported Feb. 2.
- Duke of Newcastle and Miss Candy.—Feb. 20.
- Emperor of China.—Feb. 27.
- London, Eng., Lord William Neville, fourth son of Marquis Abergavenny, to the eldest daughter of Marquis de Saturey, wealthy financier, at the Brompton Oratory.—Feb. 12.
- Ottawa, White Miss Isabel, third daughter of the late Hon. Thomas White, and Major John Cotton, of the North-West Mounted police, Regina.—Feb. 19.
- Paris, France, Ontario, Bishop of, to Miss Ada Leigh.—Feb. 20.
- Prince Henry of Battenberg marries the opera singer, Loisinger.—Feb. 23.
- Prince Leopold, son of late Prince Frederick Charles, betrothed to Princess Sophie, sister of Empress of Germany.—Feb. 14.
- Russia, Czar gives his consent to marriage of his cousin The Grand Duke Nicholas to the daughter of Count Ignatieff.—Feb. 13.
- Tampa, Fla., Duke of Sutherland obtains license to marry Miss Blair, one of the ladies who accompanied him from England.—Feb. 28.
- Toronto, Lindsay George, son of registrar of Toronto, to Cora Bethone daughter of late Mr. James Bethune, Q.C., of Cornwall.—Feb. 14.
- Torquay, Eng., Lorillard Mrs. George, of New York, to Count de Casa de Agradá.—Feb. 11.
- St. Paul, Minn., Oakes Ames, cousin of Governor of Massachusetts, to Emma Watson, assistant postmistress of St. Anthony Park.—Feb. 1.
- Yankton, Dak., Indian Agency, Gertrude Bretton, seamstress, marries Wellington, a full-blooded Sioux.—Feb. 27.
- Masonic, Kingston, Ont., Grand Master Walkem prohibits dancing in Masonic halls.—Feb. 8.
- Meat, American Meat Company, formed in New York, as rival to "Big Four," best combination in Chicago.—Feb. 22.
- MEDICAL.**—France, two professors of Pasteur Institution identify the generative microbe of diphtheria.—Feb. 5.
- Sir Morel Mackenzie speaks his mind to the London College of Physicians.—Feb. 7.
- Quebec, Rowland Dr., port physician, death of.—Feb. 22.
- Reading, Pa., death of Michael Heller "Snake-bite doctor."—Feb. 4.
- Rochester, N. Y., Longworthy Dr. H. H., death of.—Feb. 5.
- Toronto, West end physicians form themselves into an association to uphold the interests of the profession.—Feb. 4.
- Washington, death of Dr. D. W. Bliss.—Feb. 21.
- Webster County, Ky., strange disease existing, upon which the doctors disagree and from which they run away.—Feb. 4.
- Merchants Manufacturing Company, Montreal, annual meeting of.—Feb. 12.
- Merrick Rev. Joseph, death of, at Winnipeg.—Feb. 24.
- MILITARY.**—Boston "Old Guard" celebrates its tenth anniversary.—Feb. 5.
- Belgium, Radical Congress, Brussels, supports military education, but demands abolition of corrupt law.—Feb. 24.
- Canada, Dominion Artillery Association, Annual Meeting of, at Ottawa.—Feb. 21.
- Dominion Rifle Association, Ottawa, Annual meeting, and election of officers.—Feb. 20.
- France, Minister of War orders commander-in-chief to report on Col. Zenart's order as to German authorities refusing passport to French army Surgeon to go to Strasbourg to see dying mother.—Feb. 7.
- France, Minister of War issues circular reminding French officers and soldiers that political demonstrations by troops are forbidden.—Feb. 9.
- France, General Des Bordes reported as murdered at Tonquin.—Feb. 27.
- Germany, Berckenheim, Lieut. Von Young, officer of Russian Army commits suicide at Potsdam.—Feb. 28.
- Italy, Signor Bionetti declares before budget committee if Italy desires to maintain her military strength it will be necessary to increase budget forty million francs.—Feb. 23.
- Ontario Artillery Association, annual meeting at Toronto.—Feb. 5.
- Russia, Grand Duke Pladimir ordered by Czar to resign commandership of the Guards.—Feb. 28.
- Millers, Indianapolis, In-1., two hundred in session as to perfect organization of millers of the country.—Feb. 7.
- Millers, Ontario, meeting of, at Toronto discusses present rate of duty on flour.—Feb. 19.
- Minard Mrs. Margaret, dies at Sparta, Ont., aged 100 years, 6 months and three days.—Feb. 17.
- Mining, Gold, Purcell J. T., old placer mines discovered.—Feb. 14.
- Mines, Carbondale, Pa. Mine of the Delaware and Hudson Canal Company settling down.—Feb. 6.
- Miners, Plymouth, Eng., miners rescued.—Feb. 12.
- Muners, Galician, employed in Silesian coal pits ordered to quit the country.—Feb. 22.
- Mining coal, Moongahsch and Zonghroghny rivers. Miners resume operations at old rates.—Feb. 4.
- Mining coal, Vancouver Coal Mining and Load Company, registration of.—Feb. 6.
- Mining, Glace Bay Mining Association, annual meeting of, at Halifax, N. S.—Feb. 4.
- Mining, Iron, Marquette, Mich., Gen. Ayer buys Pittsburg and Lake Superior Company's iron mine for \$800,000.—Feb. 13.
- Mining, Springhill, N. S., mines shut down on account of increased railway freight rates.—Feb. 4.
- Missouri, Lotteries, People vote on constitutional amendment giving legislature power to establish.—Feb. 11.
- Montana celebrates the admission of the territory to the Union as a state.—Feb. 23.
- Montana, Flat Head Indians arming themselves, settlers in Flat Head Lake valley in danger.—Feb. 19.
- Montgomery Mrs. Maria F., widow of late General Bacon Montgomery, of St. Joseph, Mo., death of, at Beverly, Mass.—Feb. 7.
- Montreal, Board of Trade, election of officers.—Feb. 12.
- Montreal Cotton Company, annual meeting of.—Feb. 12.
- Montreal Ice Carnival, commencement of.—Feb. 4.
- Moodie Robert Baldwin, Western representative of Intercolonial Railway, death of, at Toronto.—Feb. 3.
- Mormonism, Barret, Ga., two Mormon elders caught and whipped.—Feb. 19.
- Mormonism, Cheyenne, Wis., Norwegian and Swedish converts abandon their faith and assault Mormon missionaries.—Feb. 18.
- Norris, Man., creditors of the town refuse to come to terms.—Feb. 15.
- Morocco, Germany, in return for naval station promises to support Sultan in his endeavor to free that country from tutelage of the powers.—Feb. 23.
- MURDERS.**—Baltimore, Lee Wiele, from Virginia, while insane, attacks Francis Valentine, and kills him.—Feb. 5.
- Bertie County, N.C., Mrs. Fawcett, child and two negro women murdered by two unknown burglars.—Feb. 16.
- Boston John Graham shot by an Italian.—Feb. 3.
- Boston, Thomas Taylor fatally stabbed by John A. Ross.—Feb. 5.
- Bradford, Eng., John Gill Barrett, the milkman, re-arrested.—Feb. 5.
- Dundee, Scotland, woman discovered, badly mutilated squeezed into wooden chest, arrest of husband, supposed to be "Jack the Ripper."—Feb. 11.
- England, Devonshire, Lee exonerated from Babbicombe murder by deathbed confession.—Feb. 23.
- Fairburn on the Atlantic and West Point train, Captain John T. Hearn shoots a negro who refuses to give up his seat.—Feb. 4.
- Chicago, Bradley W. S., shoots his wife and kills himself at the Hotel Corland.—Feb. 6.
- Chicago, Phila Hylander, Swedish domestic, killed by Clark George W., a colored butler, who commits suicide.—Feb. 2.
- Chicago, McLellan Miss Maude, shot by John Dempsey, who kills himself.—Feb. 5.
- East Longmeadow, Keeny Isaac, dies from injuries inflicted on him by his son Ben Keeny, who is arrested.—Feb. 1.
- Fort Smith, Ark. Two white men, two negroes, and two half-breed Indians sentenced to death by U. S. Judge Parker for murders.—Feb. 2.
- Hannburg, Danth, the murderer; and robber, guillotined.—Feb. 23.
- Managua, Nicaragua, six atrocious murders committed in the same style as the Whitechapel murders.—Feb. 6.
- Manitow, Island, Two half-breds brought to Canada, Loo charged with murdering Christian Togash.—Feb. 2.
- Memphis, Tenn., Father Ashfield, Priest of St. Peter's church, stabbed by crank named Will Reed.—Feb. 11.
- Montreal, Holden William, killed by Luther McGrath.—Feb. 9.
- New York, Henry Corlera struck on the head by his wife Emma Corlera, and killed.—Feb. 22.
- Ottawa, Kelly Mrs. Caroline, found dead with deep wound at the base of her skull.—Feb. 23.
- Philadelphia, Woman found shot in vacant lot, George Frederick arrested.—Feb. 12.
- Randolph, West Pa., Thomas Foy arrested for assaulting his wife's sister and beating her to death.—Feb. 2.
- Rutherford County, Tenn., George Dinaway murders his uncle and aunt.—Feb. 20.
- Tonquin, General Des Bordes, French commander.—Feb. 27.
- Tokio, Viscount Arimori Mori, Minister of Education, assassinated by a fanatic.—Feb. 14.

## MURDERS.—Continued.

Upton, Wis., John Brogan kills his wife and two children, and commits suicide.—Feb. 20.

Westminster, Ont., man found killed in fence corner, near the fifth concession.—Feb. 26.

Wilkesbarre, Pa., Paymaster McClure and his assistant Flanagan, Michael Bizzol found guilty of murder in the first degree.—Feb. 11.

Napanee, Ont., Opera House collapses.—Feb. 7.

National Electric Light Association, meeting of, at Chicago.—Feb. 22.

National law and order league, Boston, session of, election of officers.—Feb. 19.

NAVAL.—American, Admiral Green and officers of flagship "Lancaster" held fête at Nice.—Feb. 7.

British, commander of British man-of-war punished for boarding French vessel and taking her into Zanzibar. Order issued by British Admiral notifying order to the squadron.—Feb. 4.

British, H. M. S. "Opal" returns to New Zealand after five weeks cruise among islands of the South Seas, after burning villages for improvised murders of Europeans.—Feb. 19.

British, Lord Brassey reads paper on "Our Naval position and policy" at United Service Institution, London.—Feb. 22.

Canada, Sons of England in session at Ottawa determine to establish naval reserve corps.—Feb. 14.

England, Admiralty official caught and discharged for abstracting valuable documents.—Feb. 11.

France, bill for construction of two cruisers approved by Senate.—Feb. 28.

Germany, four German ironclads at Genoa ordered to sail for Samoa immediately.—Feb. 22.

United States, President sends list of nominations to the Senate.—Feb. 14.

United States, Rear Admiral Chandler commanding Naval Squadron in Asiatic waters at Haug Kong, death of.—Feb. 10.

United States warship "Mulinan" leaves Mare Island, Cal., for Paonua en route to Samoa.—Feb. 7.

New Hampshire, U.S. Giltman Marston of Exeter, Senator for interim, when legislature will meet, to choose a successor to Senator Chandler.—Feb. 12.

New York, dynamite bomb explodes at Stevenson's brewery.—Feb. 8.

New York, second trial of Thomas C. Kerr, treasurer of Broadway Surface Railway, for attempting to bribe aldermen.—Feb. 15.

New York Senate, resolution of congratulation to Mr. Parnell passed by.—Feb. 27.

Nicaragua Canal Company, managers say they will begin work as soon as President Cleveland signs bill incorporating company.—Feb. 9.

Nicaragua Canal, bill signed by President Cleveland.—Feb. 19.

No Man's Land, Kas., Cowboys order citizens to vacate that territory within 48 hours under penalty of death.—Feb. 26.

Nova Scotia, Chief Justice McDonald sworn in, administrator of the Government.—Feb. 1.

Nova Scotia Sugar refinery, annual meeting held at Halifax, N. S.—Feb. 5.

Nova Scotia fish harvest, report as to, for year 1888.—Feb. 6.

Nova Scotia legislature, opening of session, speech of Lieut-Governor.—Feb. 21.

Ohio Western Coal and Iron Company, Boston Safe Deposit and Trust Company files petition in Court at Logan, Ohio, praying foreclosure of mortgage on.—Feb. 13.

Olivet, Md., factional church fight in which Simon Shore inflicts fatal injuries on Thomas Donohoe, a deacon.—Feb. 4.

Oleomargarine, Pittsburg, eleven produce merchants fined for selling.—Feb. 27.

Omnibus Territorial bill, Mr. Springer agrees that New Mexico shall be expunged from the bill, and that the two Dakotas shall be admitted as states upon executive proclamation.—Feb. 1.

Onslow Lord, New Governor of New Zealand, banquet to, in London, Eng.—Feb. 16.

Ontario Artillery Association, annual meeting of, at Toronto.—Feb. 5.

Ontario Cotton Mills sold to Mr. Edward Gurney, of Toronto.—Feb. 7.

ONTARIO LEGISLATURE, motion by Mr. W. R. Meredith for return us houses of industry and pauper labor, carried.—Feb. 4.

Bill to amend Ontario Factories Act read a second time.—Feb. 6.

Mr. French's amendment of libel bill providing that a woman need not prove special damage, discussion on.—Feb. 7.

Voters' lists bill read a third time.—Feb. 12.

Public accounts of the province up to 31st Dec., 1888, laid before the legislature.—Feb. 12.

Budget introduced by Financial Treasurer Ross.—Feb. 14.

Estimates discussed as to supplies purchased from supporters of the Government.—Feb. 21.

Provincial exhibition agreed to be continued for another year at London, Ont.—Feb. 20.

Ontario Lumbermen's Association meets at Toronto, and passes resolution protesting against export duty on logs.—Feb. 7.

Orange Free State and Transvaal, President of, decides to hold conference to discuss advisability of forming federal union of the two states.—Feb. 8.

Orange Lodge, Hamilton, Ont., election of officers.—Feb. 6.

PANAMA CANAL, shares reported in Paris to be a complete failure.—Feb. 4.

Company, Paris tribunal decides adversely to demand of petitioners for dissolution of old company.—Feb. 4.

Shares, new issue, subscribed, amounts to 9,000 shares.—Feb. 5.

Mr. De Lesseps announces that if the 60,000 bonds issued through the Banque Parisienne are not taken, the enterprise must be abandoned.—Feb. 6.

Leading financial houses in Paris trying to form combination to complete the canal.—Feb. 11.

United States Senate passes bill to enable the President to protect the interests of United States in.—Feb. 11.

Illness of M. de Lesseps at Paris.—Feb. 12.

United States, House Committee on foreign affairs reports favorably on Senate bill for protecting American interest and citizens of.—Feb. 15.

Large number of laborers discharged from.—Feb. 15.

Fourth drawing of lottery boards takes place at Paris.—Feb. 15.

2,500 men discharged from works at Tavernilla.—Feb. 16.

Tribunal of Commerce at Paris decides Company is a Commercial Company.—Feb. 15.

Bill to extend franchise to widows and spinsters defeated on second reading.—Feb. 27.

Over a thousand laborers leave the Isthmus.—Feb. 26.

PARNELL TIMES, Commission, evidence of chief constable Wilkenson, Mr. Barton, clerk of the Pearl Insurance Co., Inspector Jackson, and Mr. Daly, a Galway solicitor.—Feb. 1.

Commission, Patrick Molloy, witness for the Times, arrested for perjury.—Feb. 2.

Commission, continuation of Beach's evidence.—Feb. 5.

Commission, American evidence commenced. Beach, military organizer of the Fenians in 1865, gives evidence.—Feb. 5.

Commission, Witness Beach continues evidence, and attempts to prove Irish leaguers are allied to Dynamiters.—Feb. 6.

Commission, Beach *alias* Le Caron continues his evidence; cross-examination commenced.—Feb. 7.

Commission, Trial of Patrick Molloy for perjury resumed at Bow Street Police Court.—Feb. 9.

Commission, Beach's evidence as to what occurred between him and Egan and Sullivan at Milwaukee, denied at Milwaukee by Joseph G. Donnelly, registrar of probate in that city.—Feb. 8.

Commission, Trial of Patrick Molloy at Bow Street Police Court London, Eng., commenced.—Feb. 8.

Commission, Cross-examination of informer Le Caron *alias* Beach, continued.—Feb. 8.

Commission, Troy, N. Y., Samuel Merris contradicts evidence of informer Le Caron *alias* Beach.—Feb. 8.

Commission, Le Caron or Beach, examination of, continued by Sir, Charles Russell, and concluded.—Feb. 12.

Commission, Patrick Casey offers to testify as an independent witness.—Feb. 12.

Commission, Matt Harris, at meeting of National League in Dublin, refutes Le Caron's evidence, and condemns assassins.—Feb. 13.

Commission, trial of Patrick Molloy for perjury resumed at Bow Street police station, London, Eng.—Feb. 13.

Commission, Mr. Loames, Times solicitor, hands in seven of the alleged Parnell letters.—Feb. 14.

Commission, Patrick Molloy pleads not guilty at Bow Street to charge of perjury, and is committed for trial.—Feb. 14.

Commission, Times solicitor testifies as how Parnell letters were obtained and the price paid for them.—Feb. 14.

The Times prints *fac simile* of seven of Parnell's letters, also a *fac simile* of Davitt's letters.—Feb. 16.

Pigott's evidence, Mr. Labouchere, M. P., in an interview in London, admits paying him £500.—Feb. 16.

Le Caron, informer, interview with, printed in London edition of New York Herald.—Feb. 17.

Mr. Loames gives further evidence regarding Parnell's letters, and Mr. Macdonald, manager of Times, gives evidence.—Feb. 15.

Macdonald Mr., manager of the Times, cross-examined as to how he became possessed of the Parnell letters.—Feb. 19.

Mr. Houston, Secretary of the Loyal and Patriotic league, tells how he obtained the letters.—Feb. 19.

Houston cross-examined. Examination of Richard Pigott commenced.—Feb. 20.

Mr. Gladstone speaks thereon on his arrival at Folkestone.—Feb. 20.

## PARNELL TIMES.—Continued.

Pigott's evidence resumed.—Feb. 21.  
 Commission, permission granted Messrs. Harrington and O'Brien the privilege of inspecting files of *United Ireland, and the Irishman*, to defend themselves.—Feb. 23.  
 Commission, Pigott's cross-examination continued and he declares he does not think the Parnell letters genuine.—Feb. 23.  
 Parnellite M. P.'s meet in London and re-appoint officers for the session.—Feb. 25.  
 Commission, disappearance of Pigott, warrant issued for his arrest.—Feb. 26.  
 Commission, Pigott's confession of forgery stated in court.—Feb. 26.  
 Commission, Mr. Loanes continues his evidence, Pigott's last letter read.—Feb. 26.  
 Commission, Patrick Egan interviewed at Lincoln, Neb., on Pigott.—Feb. 26.  
 Commission, Mr. Parnell goes into the box and disowns the letter.—Feb. 26.  
 Commission, resolution of congratulation to M. Parnell passed by Senate of State of New York.—Feb. 27.  
 Scotch action against Mr. John Walter as proprietor of the *Times* dismissed.—Feb. 5.  
 Scotch case, rehearing demanded at Edinburgh by Parnell's counsel. The court by consent dismisses action with costs.—Feb. 26.  
 Paucercote Sir Julian, appointed to succeed Lord Sackville as British minister to United States.—Feb. 3.  
 Pennsylvania house, bill introduced making it an offence for anyone to treat another to intoxicating drinks.—Feb. 5.  
 Pennsylvania Senate, Saturday half-holiday bill defeated.—Feb. 14.  
 Peru, Rosa Amelia, daughter of Gen. Caceres, President of, dies at Lima.—Feb. 24.  
 Peterboro, Ont., voting on high license by law results in its adoption.—Feb. 26.  
 Phelps Minister, and wife, arrive at New York from England.—Feb. 9.  
 Philippine Islands, American and other foreign representatives at Madrid try to persuade Spanish Government to allow greater facilities to foreigners desiring to invest capital in land in Philippine Islands.—Feb. 18.  
 Phonograph, trial of, in connection with long distance telephone made at New York.—Feb. 4.  
 Phosphate, Canadian Phosphate Company, report of, issued.—Feb. 7.  
 Pilgrimage, Catholic, from New York to Holy Land sails on the "Wieland".—Feb. 21.  
 Pipes, steam and drain, deputation of manufacturers waits on Minister of Customs at Ottawa, and asks that duty on be increased.—Feb. 26.  
 Plymouth, Pa., explosion at squib factory, 10 girls and 1 man killed.—Feb. 25.  
 Pneumonia, Granite, Mont., terrible epidemic at.—Feb. 9.  
 Delivers allocation on the position of the Church in the Modern World.—Feb. 13.  
 Poona, Island of, burning of village of Si for murders of Europeans, by H.M.S. "Opal," which returns to New Zealand after five weeks cruise among islands of the South Seas.—Feb. 19.  
 Poland, Posen, Prussian poles hold a meeting, and denounce prohibition of Polish elementary schools.—Feb. 21.  
 Portugal, Cabinet resigns.—Feb. 12.  
 Postage rate, Canadian, Mr. Haggart announces in House at Ottawa, that it is not the intention of the government at present to reduce the two cent postage rate.—Feb. 11.  
 Postal orders between France and United States, French chamber of deputies approves an additional convention relative to the exchange of.—Feb. 11.  
 Powderly M., at Trenton, N.J., says he could prove that employes of Pennsylvania railroad had marked ballots for their employes.—Feb. 13.  
 Presidential inauguration, Gen. Harrison departs from Indianapolis to Washington.—Feb. 25.  
 Presidential inauguration, Gen. Harrison arrives at Washington.—Feb. 25.  
 Prince Edward county, Ont., County Council passes resolution demanding prohibitory liquor law.—Feb. 23.  
 Puddlers, Birdsbor, Pa., Brooke Iron Company reduce wages of, men do not seem inclined to accept.—Feb. 9.  
 Pureell, J. T., old gold placer mines discovered.—Feb. 16.

## QUEBEC.—Continued.

Legislature, Mr. Pelletier's election bill discussed.—Feb. 7.  
 Legislature, Controverted Elections Act, the premier's amendments adopted.—Feb. 8.  
 Legislature, Legislative Assembly, Controverted Election Act passes, Provincial Fisheries bill passes committee, Bill respecting presidency of Legislative Assembly passes, Bill to appoint Councilors *ex officio* Justices of the peace passes, Bill as to suing guarantee companies passes, Bill enabling railways and insurance companies to be incorporated by letters patent read a second time.—Feb. 12.  
 Legislature, Bill to amend the election law, debate resumed.—Feb. 13.  
 Legislature, returns ordered with respect to the dairy interests of the province, Bill to amend the election law passed.—Feb. 12.  
 Legislature, Budget introduced by Mr. Treasurer Shepley.—Feb. 14.  
 Legislature, Debate on the costs of the Interprovincial conference, Mr. Pelletier's election bill passed.—Feb. 14.  
 The Leclair case discussed, Hon. Mr. Lynch exonerated from all blame in the matter. Plans for embellishing legislative buildings discussed.—Feb. 15.  
 The bill to amend articles 4653 and 4698 of the revised Statutes of Quebec, by means of which railways can be incorporated by letters patent, passed. Bill, *in*, the speaker of the legislative Council, passed.—Feb. 19.  
 Report of Committee on Agriculture, Colonization and Immigration motion to concur in same debates, and adjourned.—Feb. 20.  
 Municipal loan fund, Mr. Leblanc moves for statement as to exemptions, Bill to disfranchise Civil servants read a third time, Annual report of the commissioner of Crown lands presented.—Feb. 21.  
 Motion as to commutations and missions of sentences.—Feb. 22.  
 Laval's *chef-lieu* bill passes third reading.—Feb. 25.  
 Legislation committee considers the bill proposing to provide for appointment of inspector to Building Societies and to amend the law.—Feb. 26.  
 Committee on legislation considers the bill to enable degree of B. A. to suffice for admission to the study for the learned professions.—Feb. 26.  
 House in Committee of supply items on administration of justice and Normal school discussed.—Feb. 26.  
 The legislation committee report the B. A. bill to the house.—Feb. 27.  
 Motion to have double sessions passed, grant to Berthier Beet Root sugar factory passed.—Feb. 27.  
 Bill to amend the Revised Statutes on Lunatic Asylums discussed and passes second reading.—Feb. 28.  
 Legislative Council Bill, to amend law respecting fishing in the province passes through Committee.—Feb. 23.

RAILWAYS.—Alberta and Athabasca Company, meeting held at Fort Saskatchewan, N.W.T., in connection with Railway terminus.—Feb. 4.  
 Boston and Albany stock, advances on, rumours of consolidation with New York, New Haven and Hartford road.—Feb. 7.  
 Boston and Albany road, United States railroad committee reports bill granting authority to increase its capital stock by \$10,000,000.—Feb. 13.  
 Brandon and Rock Lake Railway, Attorney General in Manitoba legislature states Government refused assistance to.—Feb. 6.  
 Brandon and South Western line, bill for incorporation read third time.—Feb. 26.  
 Brantford, Waterloo and Lake Erie, contract signed by the contractors at Brantford, Ont.—Feb. 9.  
 Cattle rates, orders issued that owing to refusal of Kansas Railroad Commissioners to change their decision as to weighting cattle, rates at all Kansas points must again be made by car load.—Feb. 7.  
 Central Pacific Railway has judgment given by Court of Claims in its suits against the United States for withholding dividends.—Feb. 18.  
 Chattanooga Company sells controlling interests to a Boston, New York and Philadelphia Syndicate.—Feb. 28.  
 Chicago, Burlington and Quincy railroad report as to gross earnings for year 1888.—Feb. 12.  
 Delaware, Lackawanna and Western railroad, annual meeting of, at New York.—Feb. 19.  
 Eastern Railway Companies bill passes Quebec Railway Committee.—Feb. 7.  
 Gaspé short line, bill passed by Quebec Railway Committee.—Feb. 6.  
 Germany, bill introduced in Reichstag for loan of sixty million marks for army, navy and state railways.—Feb. 2.  
 Government, subsidies to, Sir John Macdonald speaks on, to deputation at Ottawa.—Feb. 14.  
 Grand Trunk, Board issues in London correspondence between Mr. Gramshaw and Sir Henry Tyler as to Canadian management.—Feb. 8.

## RAILWAYS—Continued.

Grand Trunk and Canadian Pacific, relations between, Mr. Renton secretary of the Grand Trunk, interviewed in London, Eng., by correspondent of *Toronto Mail*.—Feb. 4.

Great Eastern Railway, meeting at Montreal.—Feb. 5.

Iowa railroad commissioners rates, established for roads in that state.—Feb. 4.

Intrastate Commerce Railway Association, Burlington and Northern refuse to join.—Feb. 28.

Lake St. John, bonds of, floated on London market.—Feb. 26.

Kingston and Pembroke Company, annual meeting at Kingston.—Feb. 13.

Line from Gaspé basin to the West, American syndicate manipulating same complete their connection with the Sault and the American system by means of the charter granted by Ontario legislature to the Pacific and Atlantic Railway.—Feb. 11.

Matane Railway Company, incorporation bill passed with certain amendments, by Railway committee of Quebec legislature.—Feb. 5.

New York Central and Hudson River Railway, statement of, for quarter ending 31st Dec.—Feb. 4.

N. P. & M. vs. Sutherland, arbitrators make an award for property taken at Winnipeg for Station purposes.—Feb. 8.

Northern Pacific and Manitoba roads, bill embodying agreement introduced into Manitoba legislature.—Feb. 14.

Northern Pacific and Manitoba Bill relating to amended contract between, read third time in Manitoba legislature.—Feb. 20.

Ohio and Western railroad assigns.—Feb. 11.

Pennsylvania, orders issued, no freight except perishables to run on Sunday, men to have holiday on Sunday.—Feb. 13.

Pennsylvania road, Powderly Mr., says at Trenton, N.J., he could prove that employes of railroad had marked ballots.—Feb. 13.

Rangoon Madalay railway opened.—Feb. 27.

Reading railroad begins payment of interests at Philadelphia, on preference income bonds for 18 months.—Feb. 1.

Stewiacke Valley and Lansdowne Railway Company offers £30,000 in 6 per cent. bonds.—Feb. 14.

Vandreuil and Prescott, Township of Clarence decides to devote bonus of \$8,000 towards completion of.—Feb. 21.

Vicksburg & Meridian Railway sold under foreclosure at Jackson Miss.—Feb. 4.

Revenue, Canadian, statement of revenue and expenditure for January issued at Ottawa.—Feb. 8.

Rhode Island legislature approves Australian ballot system.—Feb. 21.

Richelieu and Ontario Navigation Company, annual meeting of, at Montreal.—Feb. 4.

**RUSSIA**—Polish trades people forced by the Palm Vitna to sign declaration that they will not speak Polish among themselves or their customers.—Feb. 7.

And Afghanistan, General Kanaroff arrives at Bokhara, Ameer, causing 300 persons to be beheaded daily.—Feb. 14.

Government grants concession for 81 years to a company which proposes to join the Black Sea and the Sea of Azov.—Feb. 12.

Language in Schools, Curator of instruction of the district of Dorpat taking decisive measures to force the use of Russian language in the schools.—Feb. 11.

Marriage of The Grand Duke Nicholas to the daughter of Count Ignatieff, Czar gives his consent to.—Feb. 13.

Orenburg, Famine prevailing, many persons dying of starvation.—Feb. 18.

Reception given by Sir R. D. Morier, British Ambassador, at St. Petersburg.—Feb. 19.

Reform of the local government, Czar declares his approval of Count Toloto's measures for, but orders they be submitted in detail to the Senate for debate.—Feb. 11.

Samarcand, Afghan insurrectionary leader Ishak Khan being treated with great honor.—Feb. 13.

Troops ordered on hurried march to re-inforce frontier posts on Afghanistan.—Feb. 12.

Afghanistan, Komaroff Gen., ordered to attack Ameer's troops if they approach Russian frontier.—Feb. 22.

Atchinnoff incident, official explanation from French Government.—Feb. 27.

Grand Duke Vladimir ordered by the Czar to resign commandship of the Guards.—Feb. 28.

18,000 troops being messed on Afghan frontier.—Feb. 28.

Sackville Lord, United States congress, further papers sent to, including Mr. Hayward's letter to Lord Sackville, his reply, and other correspondence.—Feb. 20.

St. Catharines Milling and Lumber Company meeting at Ottawa.—Feb. 12.

St. John, N.B., meeting held at, as to Canadian steamers fulfilling government contracts combining their business to Canadian ports.—Feb. 21.

Salvation Army, Quebec, reserved points in case and motion for new trial argued before appeal Court.—Feb. 1.

**SAMOA**—Tamasee's supporters reduced to 800 men. British and American consuls decline to recognize the right of the Germans to establish Martial law.—Feb. 1.

United States Congress, message from President as to how the German declaration of war was received and the Martial proclamation resolved by Prince Bismarck.—Feb. 1.

United States Congress, official minutes of conference held at Washington in 1887, with additional correspondence sent by President.—Feb. 8.

British Consul warns British subjects not to supply natives with arms, and to maintain strict neutrality.—Feb. 14.

Action of Australian authorities, Secretary Bayard gives his opinion upon, at Washington.—Feb. 2.

Senator Frye speaks at Washington on probable action of Foreign Relations Committee.—Feb. 4.

United States department of State receives from Prince Bismarck proposition for continuance of conference which he proposes he held in Berlin.—Feb. 4.

German Consul to be removed for exceeding his instructions.—Feb. 5

Secretary Bayard, interviewed by New York *Herald's* Washington correspondent explains how correspondence carried out, and gives reasons for anticipating satisfactory settlement.—Feb. 5.

The *Hamburger Correspondent* publishes letter giving an account of recent events from German point of view.—Feb. 7.

German Reichstag, White book in reference to, introduced.—Feb. 15.

Arrival at San Francisco of John C. Klein, the American newspaper correspondent charged with leading the natives against the Germans.—Feb. 16.

Herr Branders, adviser of King Tamasee, recalled to Berlin.—Feb. 20.

Four German ironclads at Genoa ordered to sail immediately for Samoa.—Feb. 22.

Prince Bismarck speaks on the relation of Germany and United States at dinner given to members of Lower house of Prussian Diet.—Feb. 22.

San Diego, Cal., completion of great flume celebrated by speeches and a parade.—Feb. 22.

Savoy, Villages of Nivollet and St. Michael destroyed, and four persons killed by avalanches.—Feb. 24.

Scarlet fever, Bismarck Amdao, Dak., reaches a most alarming stage.—Feb. 24.

Schurman Dr. J. G., professor of philosophy in Cornell University, interviewed at Ithaca as to the vacancy at the head of British Embassy at Washington.—Feb. 27.

Scotland, Hopetown Earl of, appointed Lord High Commissioner of General Assembly of Church of Scotland.—Feb. 26.

Scott Act, Breton County, league formed to enforce act.—Feb. 1.

Scott Mr. Clement, dramatic critic, left legacy of £10,000 by Miss Drew.—Feb. 14.

Seal fisheries in Bebrings Sea, President transmits to United States Senate report from Secretary of State as to.—Feb. 12.

Seed, grain frosted for, Prof. Green of State Agricultural College, St. Paul Minn., completes his report thereon.—Feb. 24.

Servia, Gradually outlaws fire the village and kidnap all the girls, populace greatly excited over the outrage.—Feb. 18.

**SHIPPING**—British barque "Roseneath" from Dublin wrecked at Port Patrick.—Feb. 2.

American ship "Bridgewater" seized by Canadian authorities, official correspondence shows vessel released, Secretary Bayard asks British Government to see that her owner gets \$28,000 compensation.—Feb. 14.

Atlantic steamers, St. John, N.B., meeting passes series of resolutions as to steamers contracting with Government confining their business to Canadian ports.—Feb. 21.

Barque "Theodore Behrem" wrecked at Texal, Scotland, ten persons drowned.—Feb. 8.

Bossiere Steamship Company, Boissiere Mr., interviews Canadian Minister of Finance at Ottawa as to \$50,000 subsidy granted to that Company.—Feb. 25.

British barque "Premier McKenzie" from Rosario abandoned at sea, part of her crew landed at Rio Grande.—Feb. 9

British barque "Gen. Grant" wrecked at Holyhead.—Feb. 9.

British Barque "Largo Bay" collides with end sinks unknown four masted steamer off Beachley Head.—Feb. 4.

British ship "Anglo Indian" lost at Tamsin during a gale, mate and 8 men reach shore in a boat.—Feb. 11.

British ship "Anglo-India" from Shanghai for Philippine Islands wrecked at Formosa, part of crew lost.—Feb. 16.

Freight rates, New York, White Star line declares war against transatlantic lines who are cutting rates.—Feb. 14.

Halifax, Boston, Halifax and Prince Edward Island Steamship Company brings action for libel against Halifax *Herald* Publishing Company.—Feb. 16.

## SHIPPING.—Continued.

Kiel, destroyed by storm at.—Feb. 24.  
 London, Eng., steamer "Neoid" collides with British ship "Kittichan" of Dungeness, and both vessels go down, 24 persons drowned.—Feb. 3.  
 Nova Scotia barque "Jonie Troop" lost, and master and ten men drowned.—Feb. 22.  
 Schooner "C. R. Oliver" sinks in Chesapeake Bay. Owner and crew lost.—Feb. 1.  
 Spanish mail steamer "Hiliran" founders, all hands lost off Island of Hilarau.—Feb. 4.  
 Spanish mail steamer "Isle de Cuba," plying between Spain and Cuba, wrecked off Corunna.—Feb. 21.  
 Steamer "Esma" from London bound for Annapolis goes ashore at Harrington Head, and is wrecked.—Feb. 6.  
 Steamer "Glouce" sunk by barque "Largo Bay" off Beachy Head.—Feb. 3.  
 Steamer "Le Gascogne" struck by a tidal wave, Yves Neuron killed, and Chief Officer Masclat and other anchors injured.—Feb. 2.  
 Steamer "Pish Peket" sinks off Klang Straits light after colliding with steamer "Chow Phya."—Jan. 15, reported Feb. 22.  
 Steamer "Symington," wrecked at Ilfracombe, Devonshire, ten persons drowned.—Feb. 2.  
 United States whaling barque "Mary Frazier" of Edgar Town, Mass., seized while cruising off Azores, by Portuguese gunboat "Acor," and towed into Fayal.—Oct. 3, 1888, reported Feb. 7, 1889.  
 Siberia, Ikrut, gold discovered by a peasant near.—Feb. 28.  
 Silver mine, Moorfield, W. Va., discovered by son of a slave formerly located at the Moorfield, a company organized to develop.—Feb. 25.  
 Slunder, France, committee of senate discusses measure providing that persons publishing slanderous personal statements shall be summarily dealt with by the correctional tribunal.—Feb. 11.  
 Small-pox, Syracuse, N.Y., two more deaths at county poorhouse.—Feb. 3.  
 Small Pox, Michigan report of State Board of Health as to existence of.—Feb. 21.  
 Small pox, Fargal, Ont., serious outbreak.—Feb. 23.  
 Small pox, Richardson County, and Sao and Fox, Indian reservations, serious epidemic at.—Feb. 22.  
 Smuggling, New York, John Williams, linen steward on Cunard steamship "Servia," arrested for smuggling silk.—Feb. 20.  
 Smuggling opium, San Francisco British sealing schooners "Walter L. Rich" and "Pathfinder" seized by Revenue cutter "Rush" in Drakes Bay.—Feb. 2.  
 Socialists, Chicago, meeting of English-speaking Socialists held, for the purpose of organizing a "Central Educational Society" to agitate principles of Socialism.—Feb. 14.  
 Socialists, Chicago, furniture makers addressed by Jens Christensen, editor of Chicago *Arbeiter Zeitung*.—Feb. 26.  
 Socialism, France, Socialists attempt to hold meeting in the Place Hotel de Ville, Paris, a number arrested.—Feb. 24.  
 Sons of England, Ottawa, convention of their order in.—Feb. 12.  
 Sons of England in session at Ottawa determine to establish naval reserve corps for Canada.—Feb. 14.  
 Soudanese evacuate Haadoub and destroy the town by fire.—Feb. 10.  
 SPAIN, Don Carlos approves scheme for the re-organization of his party.—Feb. 5.  
 Anniversary of the proclamation of the republic in 1873, celebrated.—Feb. 11.  
 Madrid, banquet given by Republican club, to celebrate the proclamation of the Republic of 1873, breaks up in disorder.—Feb. 11.  
 Congress, Prime Minister Sagasta proposes large reduction of army estimates, in order to permit reduction of taxation without reversing Free Trade policy.—Feb. 16.  
 SPORT.—Hudson River Poultry, Dog and Pet Stock Association, first show opens at Newburgh, N.Y.—Feb. 7.  
 Aquatic, Tyne, Bear beats Norval in four mile boat race.—Feb. 18.  
 Aquatic, O'Connor the oarsman proposes to Pat Steady to go to Australia under Steady's management.—Feb. 26.  
 Baseball, "Bill" Sunday, well-known player, makes his appearance as an evangelist at Chicago.—Feb. 17.  
 Baseball, bill introduced into Illinois house prohibiting playing of, on Sunday.—Feb. 15.  
 Billiards, Boston, Jacob Schaeffer challenges Maurice Daly to a match game for \$1,000 a side.—Feb. 11.  
 Billiards, Chicago, match between Frank Maggiola and Joseph Schaeffer.—Feb. 24.  
 Boxing, Jim Smith and Charley Mitchell sign articles in London to box ten rounds on April 1st, for \$200.—Feb. 16.  
 Hockey, Quebec, match between Halifax and Quebec teams.—Feb. 28.  
 Ice Carnival, Montreal, commencement of.—Feb. 4.

## SPORT.—Continued.

New York, Amateur Athletic Union, Polevaulting contest, H. H. Baxter breaks indoor record.—Feb. 8.  
 Racing, Sandown, Grant prizes won by Hibbert's "Castilian."—Feb. 20.  
 Shooting, Kansas City, Gun Club, Joseph Underwood kills 52 live pigeons straight under Hurlingham rules.—Feb. 21.  
 Suowshoe races, Montreal.—Feb. 9.  
 Skating, Dartmouth, N. S., fifteen mile race between Dowd and Laidlaw.—Feb. 25.  
 The ring, Holic deposits £25 to back Pritchard of London to fight Dempsey for £1000 a side.—Feb. 28.  
 The Ring, London, Eng., articles signed for a fight between Jim Smith and Jake Kilrain for £2,000 a side.—Feb. 9.  
 The ring, Charlie Mitchell the pugilat severely injured in London Eng., by being thrown from a dogcart.—Feb. 17.  
 Springhill, N.S., mines shut down in consequence of increased railway freight rates.—Feb. 4.  
 Stallion "Mohican" owned by Mr. McKeen of Terra Haute, Md., death of.—Feb. 7.  
 Stanhope Mr. speaks at Brighton, Eng., on the national defeuco question.—Feb. 27.  
 STANLEY II. M., letter received at Zanzibar, from Mr. Mackay, a mission ary to Lambario, dated Nov. 25, stating no direct news of, received.—Feb. 4.  
 Reported killed in an engagement with natives near Maugamba.—Feb. 18.  
 Further news of, from Lieut. Baert who arrives at Brussels from Stanley Falls.—Feb. 22.  
 Nyangura district rumours that Stanley collecting men to make war on tribes to northward.—Jan. 24, reported Feb. 25.  
 Colliers, Wales, give notice that on March 1 they will demand an advance in wages.—Feb. 23.  
 Seamen, Clyde Shipping Company, men employed by, decide to accept 7 per cent. advance.—Feb. 27.  
 Steamship freights, New York, White Star Line declares war against transatlantic lines who are cutting rates.—Feb. 14.  
 Stormont Cotton Company, annual meeting of.—Feb. 21.  
 Street John W., inventor of improved cattle car, dies at Chicago.—Feb. 16.  
 STRIKES, coke men, Pennsylvania strike commenced.—Feb. 2.  
 Coke, Connellsville, Pa., ended, all mines at work except "Standard," "Quintown" and "Mammoth."—Feb. 7.  
 Coke, Pennsylvania, strike practically ended.—Feb. 9.  
 Cotton weavers, Cornwall, Ont., the strikers go to the mill, but finding their demands not complied with refuse to work.—Feb. 29.  
 Engineers, Minneapolis Motor Street railway.—Feb. 9.  
 France, North extending rapidly owing to agitation of Socialists.—Feb. 14.  
 Glassworkers, Charleroi, collisions between police and strikers.—Feb. 5.  
 Miners, Monoagahela and Youghogheeny rivers, coal miners resume operations at old rates.—Feb. 4.  
 Seamen, Cork, Glasgow shipping companies concede, advance demanded.—Feb. 4.  
 Seamen, Dublin, vessels unable to obtain crews.—Feb. 4.  
 Seamen, Glasgow, three thousand seamen and firemen out.—Feb. 1.  
 Seamen, British ports men freely signing articles at compromised rates.—Feb. 18.  
 Street car employes, secret circular issued by advanced champions of labor as to bribe takers and traitors.—Feb. 15.  
 Street car employes, New York, virtually ended.—Feb. 3.  
 Street car employes, New York, the executive committees declare the strike off.—Feb. 6.  
 Toronto, laborers on Dominion Improvement works.—Feb. 4.  
 Weavers, Cornwall, Ont., two hundred go out, citizens decide not to grant a bonus.—Feb. 14.  
 Stallion "Woodnut" sold by M. D. Halley, of Vallign, Cal., for \$50,000.—Feb. 12.  
 Sugalla, bombarded by French cruiser commanded by Admiral Aubry. Five members of Atchinoff expedition wounded and others captured.—Feb. 22.  
 Sunday *Herald*, publication of, in London, denounced from many pulpits.—Feb. 3.  
 Switzerland, extensive land slides at Flenvier, Neuchatel.—Feb. 14.  
 Switzerland, Obermalt and Solothurn, many houses destroyed and several deaths caused.—Feb. 22.  
 Tabiti, schooner "Tabiti" arrives at San Francisco, and reports great excitement prevailing there in consequence of news from Samoa.—Feb. 18.  
 Tea, New York, 50,000 boxes, valued at \$300,000, bought by one customer.—Feb. 8.

**TELEGRAPHS**, Australia and Canada, Australian colonies unite in inviting Canada to send delegates to Australia to consider the question.—Feb. 11.

**THEATRICAL**, Napanee, Ont., Opera House collapses.—Feb. 7.

Aldershot, Eng., Theatre Royal destroyed by fire.—Feb. 8.

Divorce suit, brought by Mr. Izard against his wife, the actress, Maria Temple, with Henry J. Leslie, proprietor of Lyric Theatre, as co-respondent, results in verdict with £5,000 damages for plaintiff.—Feb. 14.

France, Paris, "The Marquis," comedy in three acts, by Victorien Sardou, produced at the Vaudeville and was a failure.—Feb. 11.

London, England, Wilson Barrett's new play "Now-a-Days" produced at Princess' Theatre.—Feb. 28.

Minneapolis, Kate Claxton, the actress, has severe stroke of apoplexy.—Feb. 14.

New York, Hawthorn & Co. sue Mrs. Langtry for \$3,700 for furnishing kilts and plaids for Highlanders in play of *Maebeth*.—Feb. 15.

St. Louis, Mary Anderson adversely criticized by the newspapers.—Feb. 23.

Vienna, Sralh Bernhardt achieves enormous success in her impersonation of "Fedora."—Feb. 13.

Theftford, Asbestos Mining Co., applies for letters of incorporation at Quebec.—Feb. 24.

Trade, England, Lord Salisbury addresses Chamber of Commerce, London, England, as to revival of trade.—Feb. 27.

Transvaal and Orange Free State, Presidents, decide to hold conference to discuss advisability of forming federal union of the two states.—Feb. 8.

Trichinosis, La Porte County, Ind., twenty persons attacked with.—Feb. 26.

**TRUSTS**—Sewer pipes, nineteen of the largest firms in United States form combination.—Feb. 9.

"Big four" beef combination, American Meat Company formed in New York as a rival to.—Feb. 22.

Gas, Chicago, Standard Oil Company obtains control of.—Feb. 26.

Store founders, Maritime Provinces to, meet upper province competition.—Feb. 25.

Windsor glass, Pittsburg, Pa., importers of Belgian glass refuse to join, and trust falls through.—Feb. 6.

Tupper Sir Chas., responds to toast of the Colonial empire at banquet to Lord Onslow in London, Eng.—Feb. 16.

Turkey, Sultan exiles Aera, one of principal sheikhs of Zemen, for inciting Arabs to revolt.—Feb. 13.

Typhus Fever, Hungary, epidemic at Doboka.—Feb. 8.

Typhus fever, Belgium, outbreak at Hippage near Verriers.—Feb. 22.

Union League Club, Chicago, celebrate anniversary of Washington's birth.—Feb. 22.

Unionists, Liberal and Radical, conference at Glasgow, speech by Mr. Chamberlain.—Feb. 12.

Unionist meeting, Bristol, Eng., breaks up with cheers for Gladstone.—Feb. 12.

**UNITED STATES CONGRESS**, Samoa, message from President as to how the German declaration of war was received, and the Martial proclamation rescinded by Prince Bismarck.—Feb. 1.

Agreement between the Creek nation and the United States transmitted by the President for ratification.—Feb. 5.

Ministry, Evans Senator, offered Attorney Generalship, which he declines vide *New York Commercial Advertiser*.—Feb. 1.

Senate, British extradition treaty rejected.—Feb. 1.

Senate, Finance Committee hears evidence from John S. Bell, chief of the secret service of the Treasury as to counterfeiters in circulation.—Feb. 7.

Congress, Samoa, official minutes of conference held at Washington in 1887, and additional correspondence sent by President.—Feb. 8.

House of Representatives, proposed congress as to plan of arbitration for settling disputes, representative Townsend introduces bill to amend act so as to include Canada.—Feb. 12.

Senate, British extradition treaty, discussion on a motion to remove the injunction of secrecy from the proceedings.—Feb. 11.

Senate passes bill to enable the President to protect the interests of United States in Panama.—Feb. 11.

Senate, Seal fisheries in Behring's sea, President transmits report from Secretary of State as to.—Feb. 12.

Senate, naval nominations, President sends down list of.—Feb. 14.

Senate confirms the nomination of Carrol D. Wright, to be commissioner of labor.—Feb. 14.

**UNITED STATES-SAMOA.—Continued.**

Senate, bill for protection of Salmon fisheries in Alaska referred to foreign relations committee.—Feb. 28.

Backville case, further papers sent to Congress, Mr. Bayard's letter to Lord Salisbury, his reply, and other correspondence.—Feb. 20.

Mr. Morgan introduces resolution, inviting Parliament and officers of the Dominion to visit the United States and investigate the industries and institutions of the country.—Feb. 18.

House committee on foreign affairs reports favorably on Senate bill for protecting American interests and citizens of Isthmus of Panama.—Feb. 15.

And Japan, supplementary treaty of commerce, amity and navigation between, signed.—Feb. 20.

Utah, Ogden, Gentiles successful over the Mormons in municipal elections.—Feb. 11.

Vancouver coal mining and land company, registration of.—Feb. 6.

Villacampa Republican General, dies in prison at Madrid.—Feb. 17.

Washington's birth, anniversary of, celebrated by Union League Club Chicago.—Feb. 22.

Webster County, Ky., strange disease existing at, from which the Doc tor run away.—Feb. 4.

Wentworth Pioneer and Historical Society, Hamilton, Ont., hold their meeting and adopt constitution.—Feb. 7.

Wheat deal, Buffalo, N. Y., the largest cash wheat deal on record in the United States.—Feb. 20.

Western Assurance Company, Annual meeting at Toronto.—Feb. 21.

White caps, Renfrew, break into house of Adolphe Sauvé, one of them wounded by a shot from wife.—Feb. 25.

White Caps, Harrisburg, Va., two colored men severely handled.—Feb. 2.

Winnipeg, Mr. Erastus, interviewed at New York as to Mr. Townshend's bill for including Canada in proposed conference as to commercial union with the United States.—Feb. 15.

Wissmann, Captain arrives at Alexandria and proceeds to Cairo to recruit blacks for African expedition.—Feb. 25.

Wolves, Aitken Mine, two children attacked and devoured by.—Feb. 20.

Women's enfranchisement, association for, formed at Toronto.—Feb. 4.

**WRECKS**, Barrington Head, N.S., steamer "Esme" from London bound to Annapolis goes ashore.—Feb. 6.

Beachy Head, steamer "Glouce" sunk by barque "Largo Bay."—Feb. 3.

Beachy Head, British Barque "Largo Bay" collided with and sunk unknown four-masted steamer.—Feb. 4.

British Barque "Premier McKenzie" from Rosario abandoned at sea.—Feb. 9.

Chesapeake Bay, schooner "C. R. Oliver" sinks in a squall, owner and crew lost.—Feb. 1.

Chicomicomico, N. C., Nova Scotia barque "Josie Troop" lost, and master and ten men drowned.—Feb. 22.

Corunna, Spanish mail steamer "Isla de Cuba," plying between Spain and Cuba.—Feb. 21.

Formosa, British ship "Anglo-India" from Shanghai for Philippine Islands.—Feb. 16.

Holyhead, British barque "Gen. Grant."—Feb. 9.

Ilfracombe, Devonshire, steamer "Symington," ten persons drowned.—Feb. 7.

Island of Bilirau, Spanish mail steamer "Bilirau" founders, all hands lost.—Feb. 4.

Klang Straits light, steamer Piab Pekret collides with steamer Chow Phya, and sinks.—January 13th, reported Feb. 22.

London, Eng., steamer "Nereid" collides with British ship "Killochan" of Dungeness, and both vessels go down, 24 persons drowned.—Feb. 3.

Port Patrick, British barque "Rosenath" from Dublin.—Feb. 2.

Tamso, British ship "Anglo-Indian" lost during a gale, mate and 8 men reach shore in a boat.—Feb. 11.

Webster, Rhode Island, Julia Maher dies of paralysis after being gnawed by rats.—Feb. 11.

Wheat crop, Central Illinois, Hessian fly destroyed whole fields.—Feb. 11.

Napanee, Ont., two young men notified to go to work or quit the town.—Feb. 11.

Winnipeg *Free Press* purchases the *Morning Call*.—Feb. 9.

Y. M. C. A., Ontario and Quebec, convention at Ottawa.—Feb. 1.

Young George Paxton, professor of mental and moral science at University College, Toronto, death of.—Feb. 26.

I an  
with  
cul  
pul  
you  
libr  
  
find  
Cur  
I  
such  
year.  
M  
heart  
enter  
year  
Judg  
in all  
"It s  
refer  
M  
writ  
a des  
M  
congr  
its ex  
M  
the In  
impor  
  
Mr. I  
for som  
demand  
writers  
aide-me  
It is en  
necessa  
clear to  
date our  
render h  
tenting  
truck of  
this to  
plan the  
friends,  
which be  
or the pr  
to the ir  
great ric  
and servi  
advance.

The Ind  
versity str  
reviews re  
  
The Inc

Commencing with Vol. II No. I the dates given in the *Index* are the actual dates of the occurrences; not as hitherto the dates of publication.

The *Index* is published four times a month; but to form a complete file for the year it is necessary to preserve only the first issue in each month.

The intermediate issues contain the news of the current month to date.

We have to acknowledge with thanks the receipt of a large number of papers offered in exchange for the *Index*. As the *Index* is published principally for the use of editors, and has to depend chiefly upon its contemporaries for support, it is obviously impossible for it to indulge in the luxury of an exchange list.

The subscription is \$6 per annum, payable yearly or half yearly in advance. Remittances should be made to

HENRY DALBY,  
P. O. Box 864,  
MONTREAL, Que.

MR. MARTIN J. GIFFIN, LIBRARIAN OF PARLIAMENT, Ottawa, writes: "I am sending you a subscription for two copies of your '*Index*,' which will be most useful and which deserves encouragement. If you will take particular pains to give the dates and figures of elections and the dates of speeches of public men, with reference also to the place at which the speech was delivered, you will do a very grateful thing for public people and editors, and I may add librarians."

MR. JOHN M. DOANE, STATE LIBRARIAN of Ohio, writes:—"Enclosed please find six dollars, in payment for State Library subscription to the '*Index of Current Events*' for 1888."

I regard it as a very valuable publication, and hope that you may meet with such success as to warrant its continuance, for it will grow more valuable every year.

MR. HERRIES, OF THE BROOKLYN *Eagle*, writes:—"I congratulate you most heartily upon having done good thing, a very good thing, in starting the '*Index*' enterprise. I hope I may have the joy of congratulating you upon your success a year hence. A man with *Index* on the brain is one after my own heart. My judgment was formed upon Number 1; if the *Indexing* is kept up as thoroughly in all subsequent numbers it will be a great help to us."

SIR CHARLES TUPPER, BART., HIGH COMMISSIONER FOR CANADA, writes:—"It seems to me to be a very useful publication, and one that will be valuable for reference purposes."

MR. BURK, ASSOCIATE EDITOR OF THE PHILADELPHIA *Public Ledger*, writes:—"Your *Index* is highly appreciated at this office, where it has long been a desideratum."

MR. GOLDSCHMIDT OF THE "TORONTO *Empire*," writes:—"Allow me to congratulate you most cordially upon your admirable *Index*. The idea and its execution are alike worthy of all praise."

MR. YADEN, OF THE "NEW-YORK *Morning Journal*," writes:—"I find the *Indices* of great value, saving, as they do, much valuable time in looking up important events."

(FROM THE MONTREAL GAZETTE).

Mr. Henry Dalby, a well-known and respected journalist of this city, has been for some months past publishing a periodical which all persons, whose business demands accuracy of date, all students of contemporary history, all newspaper writers, and, in fact, all persons who would have within reach an unfailing *aide-memoire* as to the chronology of their own time, will find extremely useful. It is entitled "*The Index of Current Events*," and is published weekly. Though necessarily brief, the record of each successive noteworthy event is sufficiently clear to be no mistake as to its purport. Where fuller information is sought, the date supplies prompt indication of hundreds of authorities on the subject, as the reader has only to turn up the file of his local newspaper to bring all the particulars back to his mind. No memory however active and extensive could keep track of the rapid succession of occurrences of every nature and clime which, in this telegraphic age, form the raw material of history. But by this ingenious plan the searcher is never astray. Instead of perplexing himself and boring his friends, he consults his *Index*, and there, if a politician, he finds the election of which he desired the date; if a business man, the failure, or the rise in wheat or the promulgation of the new tariff; if an insurance agent, he is at no loss as to the time in which he is interested; if a sportsman, he can learn when the great race comes off. In fine, such a chronological record is invaluable to some and serviceable to all. The subscription is \$6, payable yearly or half-yearly, in advance. Address, 34 University street, Montreal.

(FROM THE ALBANY SUNDAY PRESS.)

The *Index of Current Events*, a weekly publication by Henry Dalby, 34 University street, Montreal, is an eminently valuable enterprise. It thoroughly reviews recent events, and is a great help to historically inclined readers.

# Photo-Engraving.

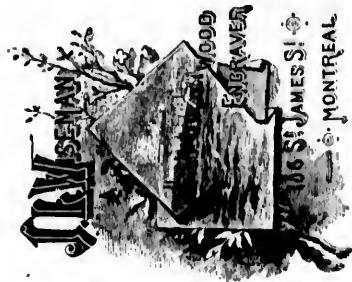

# Pen Drawing & Map Etching.

WHEN

YOU \* ARE \* READY

To order any more

**BINDING**

PLEASE CALL UP

TELEPHONE \* 230

Or send a POSTAL CARD to

**JOHN LOVELL & SON,**

23 & 25 St. Nicholas St., Montreal

Best work at moderate prices.

## APPOINTMENT WANTED.

POSITION WANTED as correspondent for any papers or journals of whatsoever character. Am well acquainted with the work.

H. S. PICKETT, 11 Scott, Buffalo, N. Y.



FLUCTUATIONS OF THE STOCK MARKET.

FEBRUARY.

	Friday 2	Saturday 3	Sunday 4	Monday 5	Tuesday 6	Wednesday 7	Thursday 8	Friday 9	Saturday 10	Sunday 11	Monday 12	Tuesday 13	Wednesday 14	Thursday 15	Friday 16	Saturday 17	Sunday 18	Monday 19	Tuesday 20	Wednesday 21	Thursday 22	Friday 23	Saturday 24	Sunday 25	Monday 26	Tuesday 27	Wednesday 28	Thursday 29	
Money on call, New York.....	.....	.....	.....	.....	.....	.....	.....	.....	.....	.....	.....	.....	.....	.....	.....	.....	.....	.....	.....	.....	.....	.....	.....	.....	.....	.....	.....	.....	.....
Sterling Exchange, New York.....	487	487	487	487	486½	486½	486½	486½	486½	487	487	487	487	487	487	487	487	487	487	487	487	487	487	487	487	487	487	487	487
<b>NEW YORK STOCKS CLOSING QUOTATIONS.</b>																													
Canadian Pacific.....	52½	52½	52½	52½	52½	52½	52½	52½	52½	52½	52½	52½	52½	52½	52½	52½	52½	52½	52½	52½	52½	52½	52½	52½	52½	52½	52½	52½	52½
New York Central.....	110½	110½	110	110	110	110	109½	109½	109½	109½	109½	109½	109½	109½	109½	109½	109½	109½	109½	109½	109½	109½	109½	109½	109½	109½	109½	109½	109½
Central Pacific.....	35½	35½	36	36	36	36	36	36	36	36	36	36	36	36	36	36	36	36	36	36	36	36	36	36	36	36	36	36	36
Eric.....	29½	29½	29½	29½	29½	29½	29½	29½	29½	29½	29½	29½	29½	29½	29½	29½	29½	29½	29½	29½	29½	29½	29½	29½	29½	29½	29½	29½	29½
Louisville & Nash.....	59½	59½	59	59	59	59	59	59	59	59	59	59	59	59	59	59	59	59	59	59	59	59	59	59	59	59	59	59	59
Lake Shore.....	104½	104½	104½	104½	104½	104½	104½	104½	104½	104½	104½	104½	104½	104½	104½	104½	104½	104½	104½	104½	104½	104½	104½	104½	104½	104½	104½	104½	104½
Northern Pacific Preferred.....	61½	61½	60½	60½	61	61	61	61	61	61	61	61	61	61	61	61	61	61	61	61	61	61	61	61	61	61	61	61	61
Northwest Preferred.....	.....	.....	.....	.....	.....	.....	.....	.....	.....	.....	.....	.....	.....	.....	.....	.....	.....	.....	.....	.....	.....	.....	.....	.....	.....	.....	.....	.....	.....
Reading.....	49½	49½	49½	49½	49½	49½	49½	49½	49½	49½	49½	49½	49½	49½	49½	49½	49½	49½	49½	49½	49½	49½	49½	49½	49½	49½	49½	49½	49½
St. Paul.....	66½	66½	64½	64½	64½	64½	64½	64½	64½	64½	64½	64½	64½	64½	64½	64½	64½	64½	64½	64½	64½	64½	64½	64½	64½	64½	64½	64½	64½
Union Pacific.....	64½	64½	64	64	64	64	64	64	64	64	64	64	64	64	64	64	64	64	64	64	64	64	64	64	64	64	64	64	64
<b>MONTREAL STOCKS SELLING PRICES.</b>																													
Bank of Montreal.....	226	226½	228	228½	230½	231	231	231	231	231	231	231	231	231	231	231	231	231	231	231	231	231	231	231	231	231	231	231	231
Merchants Bank.....	137	137½	137	137½	137½	137½	137½	137½	137½	137½	137½	137½	137½	137½	137½	137½	137½	137½	137½	137½	137½	137½	137½	137½	137½	137½	137½	137½	137½
Bank of Commerce.....	118½	118½	118	118	118½	118½	118½	118½	118½	118½	118½	118½	118½	118½	118½	118½	118½	118½	118½	118½	118½	118½	118½	118½	118½	118½	118½	118½	118½
Montreal Telegraph.....	89	89	90	90	90½	90½	91	91	91	91	91	91	91	91	91	91	91	91	91	91	91	91	91	91	91	91	91	91	91
Montreal Gas.....	198½	198½	200	200	201	201	201	201	201	201	201	201	201	201	201	201	201	201	201	201	201	201	201	201	201	201	201	201	201
Northwest Land.....	65	64	64	64	65	65	65	65	65	65	65	65	65	65	65	65	65	65	65	65	65	65	65	65	65	65	65	65	65
Richelieu & Ontario.....	55	55½	55½	55	55	55	55	55	55	55	55	55	55	55	55	55	55	55	55	55	55	55	55	55	55	55	55	55	55
Street Railway.....	187½	187½	187	187	187½	187½	187½	187½	187½	187½	187½	187½	187½	187½	187½	187½	187½	187½	187½	187½	187½	187½	187½	187½	187½	187½	187½	187½	187½
Canadian Pacific.....	52½	51½	52½	52½	52½	52½	52½	52½	52½	52½	52½	52½	52½	52½	52½	52½	52½	52½	52½	52½	52½	52½	52½	52½	52½	52½	52½	52½	52½

Washington's birth day.  
N. Y. Markets closed.

# THE INDEX OF CURRENT EVENTS.

VOL. II, No. 12.

MONTREAL, APRIL 4, 1889.

\$6.00 PER ANNUM.  
PUBLISHED WEEKLY.

## MARCH.

Abyssinia, army besieging Kassala, Senoussi's army marching on Khartoum.—March 7.

Abyssinia, war declared against, by King Menelek of Shoa.—March 9.

ACCIDENTS.—Drowning, Decatur Co., family of Ben Llynes, nine in all, drowned in a swamp near Tennessee river.—Feb. 27, rep. March 2.

Drowning, Mexico, Lake Chalpa in State of Julio 17 persons sailing capsized in a gale and drowned.—March 25.

Drowning, Mexico, Lake Chapala near Guadalupe, Steamer "Oceania" founders with large number of excursionists on board.—March 24.

Drowning, Stornoway, three fishing boats swamped, and twelve occupants drowned.—March 20.

Explosions, mines, fire damp in colliery kills 15 and injures 6 persons.—March 15.

Explosion, New York, explosion in electric subway at Twenty-third street and Fifth Avenue.—March 25.

Explosion, Brynally colliery, Wrexham, 20 persons killed.—March 13.

Explosion, Pittsburg, Pa., 4 men killed and others fatally injured by boiler explosion.—March 14.

Explosions, Roswell, Wurttemberg, seven persons killed at gunpowder factory.—March 12.

Fires, Berthier, Que., Ville-Marie Bank destroyed.—March 3.

Fires, Carberry, Man., Horison & Co's elevator destroyed.—March 19.

Fires, Charlottetown, P.E.I., hospital considerably damaged.—March 1.

Fires, Chicago, E. W. Blatchford's six story building, damages \$300,000.—March 29.

Fires, Dover, N. H., City Hall and adjoining buildings destroyed.—March 22.

Fires, Elizabeth, N.J., steamboat "Kill von Kull," of New Jersey Central Railroad, destroyed.—March 3.

Fires, Helena Mount, the lower works of the Anaconda Smelting Co. destroyed, \$1,000,000 damages.—March 14.

Fires, Halifax, N.S. The Citadel.—March 23.

Fire, Lawrence Station, N.B., McGregor Mrs., wife of Rev. Mr. McGregor, burned to death.—March 24.

Fires, London, Eng., Baltic timber yard near Buckingham Palace loss \$300,000.—March 28.

Fires, Milwaukee, building owned by Mrs. Bosworth, and occupied by J. E. Jenner & Co, milliners, 12 firemen buried.—Feb. 28, rep. March 2.

Fires, Portland, N.B., James Harris & Co's rolling mill destroyed.—March 12.

Fires, Prairie, Dakota, much damage done by.—March 30.

Fires, Russia, town of Pinsk destroyed, six persons burned to death.—March 22.

Fires, Sunnyside, Manitoba, stables of D. Gillespie.—March 31.

Fire, Ship "St. Cloud," on voyage from New York to Java, burned at sea.—Rep. March 19.

Fires, Weedon, England, British government small arms stores.—March 2.

Fires, Williamsburg, Eureka Stone Manufacturing Company, many employees badly injured.—March 26.

Fire arms, Winnipeg, Evans W. H., accidentally shot in New Douglas house by his companion C. Harker.—March 24.

Flooding, Atlantic City visited by destructive flood tide, several houses wrecked and foundations of others seriously weakened.—March 22.

Frozen, Prince Albert, N.W.T., Donald and John Finlayson, of Paris, Ont., overtaken by blizzard and frozen to death.—March 13.

Poisoning, Montreal, Boyne C. W., medical student, takes fatal dose of strychnine in mistake for chloral.—March 6.

Railway, Cotacau Landing, P. Q., John Hallinan, brakeman, crushed to death between two cars.—March 23.

Railway, Mativoto, North-bound passenger train from City of Mexico on Mexian National Railway wrecked, engineer and fireman killed.—March 25.

Railway, Oaklade, Freight train on Canadian Pacific Railway derailed.—March 24.

## ACCIDENTS.—Continued.

Railway, Lake and Tientsin Railway, resulting in many deaths.—March 27.

Railway, Paris, Ont., mixed train on Grand Trunk Ry., for Stratford, dashed into by freight train from Brantford, Mrs. Elizabeth Law and May Law killed.—March 1.

Railway, Illinois Express from Halifax, on Intercolonial Ry., collisions with special freight train, 4 men killed.—March 19.

Storm, New Hanover Co., N.C., young colored man killed by enormous hail-stones.—March 19.

Afghanistan, forces advancing from Herat and the Emir of Bokhara preparing to attack them.—March 1.

Afghanistan, Ameer of, denies that he has any designs against Russia.—March 11.

AFRICA EAST.—Zanzibar, Fight takes place between Arabs and Germans, latter re-occupy Lamuoy, Hushir Arab leader wounded.—March 3.

Tangiers, British channel squadron arrives at, to support England's claims regarding cable and other matters.—March 16.

Tangiers, two British ironclads sail from Gibraltar to join squadron at.—March 20.

Despatches report insurrection not spreading, German Company's employes collect duties in harbor occupied by rebels.—March 21.

Zanzibar, Arab show arrives at, and repairs being fired at by German gunboats and her captain killed.—March 6.

Zanzibar, Dr. Peters secures 100 Somalis to cover the advance of expedition under his command.—March 6.

Zanzibar, Missionaries captured by insurgents released on payment of \$3,000 in addition to ransom money, followers of Buschere retreating into interior.—March 12.

Zanzibar, notwithstanding blockade, arms being imported in large quantities.—March 12.

Zanzibar, Capt. Wissman and Dr. Peters arrive at.—March 31.

Zanzibar, party of 230 men land from German man-of-war "Schwalbe" and burn Koudutchi, despatch received.—March 28.

Algeria, soldier named Perduche sentenced to death in Oran for throwing quid of tobacco in face of Col. Thierry, while being tried for desertion.—March 15.

Anarchists, Aix-la-Chapelle, 5 anarchists arrested.—March 11.

Annexation Canadian, Wiman Mr. Erasmus and Denison Col. George, correspondence between, published.—March 4.

Architects, Ontario, meet at Toronto and organize for the purpose of securing legislation to place standard of entry into professional ranks.—March 21.

Arkansas State Senate pass act changing election law to that framed on Australian system.—March 6.

Asbestos and Antimony Co., Canadian prospectus of, issued.—March 5.

Atchinoff expedition, official Russian report issued as to.—March 5.

Atchinoff expedition, Czar orders official enquiry into.—March 8.

Atchinoff expedition, members who were brought to Sebastopol allowed to return home, Atchinoff detained.—March 20.

Atlantic city visited by destructive flood tide, several houses wrecked and foundations of others seriously weakened.—March 22.

Australian wheat crop falls short of estimated product for season.—March 23.

AUSTRIA.—On the alert for trouble in the Balkans, troops ordered to be in readiness on Servian frontier at Udina.—March 14.

Government orders Danube Navigation Co. to hold steamers for an emergency. Tugs and barges concentrated to enable troops from Nensatry to be transported to Servian shore, vide London Standard's Buda Pesth correspondent.—March 14.

Reichsrath, Lower House adopts bill prohibiting sale of foreign lottery tickets in Austria.—March 22.

Lottery prohibition, Greek Government protests against.—March 25.

Baldwin Detective, and posse who went into the wilds of Wyoming and McDowell counties, W. Va., to break up gang of distillers, surrounded, and lives threatened.—March 18.

Baltimore, New hospital, Emperor William, of Germany, send cheque for \$150.—March 27.

Banks, Denver, Col., Mr. Moffatt, president of First National Bank, compelled to make out and pay cheque for \$21,000.—March 29.

Street Railway.....  
Canadian Pacific.....

Bank, La Banque Nationale, Quebec, Hon. Edouard Thibaudan resigns presidency, Mr. A. Gagnon nominated in his stead.—March 7.

Banks, deposit receipts, Master in Ordinary, at Toronto, in the case of Morton & Black and Central Bank, holds that deposit receipts cannot be looked upon as negotiable securities.—March 9.

Bavaria, fiscal statement of government shows surplus of 12 million marks.—March 6.

Havaria, quarrel between Princes and Generals, several of latter dismissed.—March 6.

Bavaria, ministerial council instructs representatives in Federal Council to oppose passage of New German Anti-Socialist law.—March 30.

Behring Sea closed to all nations. Proclamation by General Harrison issued.—March 22.

Behring Sea, question discussed in Canadian House of Commons.—March 26.

Behring Sea, question asked in British House of Commons as to three sealing ships arrested in 1887.—March 28.

Belgium, Agriculture league federation adopts resolution favoring imposition of import duty upon all agricultural products.—March 20.

Bermuda, entire garrison officers and men of English Fort Cunningham desert.—March 14, Reported 25.

Biarritz, arrival of Queen Victoria at.—March 7.

Births, Princess Irene, wife of Prince Henry of Prussia, brother of Emperor of a son.—March 20.

Bismarck, Dak., opium smuggling trial closes as.—March 11.

Black Caps, Kingston, Ont., organization formed, secretary notifies idlers and wife beaters.—March 14.

Bokhara, Emir of, decorated by Czar with the White Eagle.—March 25.

Boodle Trial, New York, Kerr, verdict of not guilty returned.—March 15.

Booth Miss Mary L., editor of *Harpers's Bazaar*, New York, death of.—March 5.

Breach of Promise case, London, Eng., Broughton Miss Phyllis, actress, action against Viscount Dungen, compromised.—March 28.

Breweries, Chicago, three large breweries sold to British syndicate, represented by Mr. Bigelow, of Boston, for \$1,800,000.—March 5.

Breweries, New Hampshire, Frank Jones concludes deale of his two breweries to English investors.—March 18.

Breweries, Rochester, N.Y., three leading breweries purchased by English syndicate.—March 6.

Breweries, Syracuse, N.Y., Brewing and Malting Co., a failure.—March 21.

Bright Rt. Hon. John, M.P., death of, at Rochedale, Eng.—March 27.

Bright Mr. John, M.P., Lord Salisbury's exordium on, in British House of Lords.—March 28.

Bright Mr. John the late, Mr. Gladstone pronounces eulogy upon, in British House of Commons.—March 29.

British American Land Company, dividend of 30 shillings per share proposed.—March 27.

British American Association, Chicago council have a riotous meeting in Sherman House.—March 28.

British Columbia Canning Co., prospectus issued by.—March 3.

British Columbia Legislature, important railway project to bring San Francisco into closer communication with Victoria, discussed.—March 18.

Bucket shops, Toronto, Ont., Priestman Joseph, committed for trial for keeping a gaming house.—March 18.

Buckingham and Chandos, Duke of, death of.—March 27.

Bulgaria, M. Zankoff in interview at Vienna says the Czar declared he would not meddle forcibly with Bulgaria.—March 8.

Bulgaria, Prince Alexander of Battenberg writes to Government, claiming a million francs as purchase price of his estates.—March 12.

California Legislature, adjournment of *sine die*.—March 18.

Canada Company, meeting at London, Eng.—March 27.

Canada North-West Land Company, annual meeting at Edinburgh.—March 20.

Canada Northwest Land Co.'s report issued.—March 16.

Canadian Asbestos and Anthimony Co., prospectus of, issued.—March 5.

CANADA, PARLIAMENT OF.—The fisheries question, Hon. Mr. Laurier's amendment defeated.—March 1.

Frauds on Farmers Committee meet, Ignace Rousseau, farmer, of Ste. Apollinaire, Que., gives evidence.—March 1.

Commons, bill to amend winding up Act introduced, Ottawa and Montreal Boom Co. bill withdrawn, Sir Chas. Tupper in the House, North West Mounted Police, discussion on motion for return of crimes committed by members, and sentences passed upon.—March 4.

Commons, Budget speech by Hon. George Foster.—March 5.

Estimates submitted to the House.—March 5.

Commons, debate on the Budget.—March 7.

House, Budget debate continued by speakers on both sides.—March 8.

House, amendment to copyright, amendment to Supreme Court and Exchequer Court Act, Mr. Wilson's Labor Union bill, Montreal Harbor bill introduced.—March 11.

## CANADA, PARLIAMENT OF.—Continued.

Senate, resumed debate on Hon. John Macdonald's motion as to trade.—March 11.

House, Midnight closing resolution, a P.E.I. railway grievance discussed, Rocky Mountain Park, sale of liquor in.—March 11.

House, Budget debate, interesting figures quoted by Dr. Ferguson.—March 12.

House, the wreckage bill sanctioned, Mr. Brown's pigeon protection bill killed.—March 13.

House, Budget, debate on, continued.—March 14.

Bill to make further provision respecting the speedy trial of certain indictable offences passed. Inspection, cutting and measuring of timber bill for, introduced.—March 15.

Commons, grain and seeds, duty on, Mr. Platt's resolution, discussion on, L'Artois breakwater, motion for copies of correspondence.—March 18.

Senate, interest, legal rate of, Senator Power's 1% to change, thrown out.—March 18.

Budget debate concluded, Sir Richard Cartwright's resolution defeated.—March 20.

Senate, bills assented to by deputy governor.—March 20.

Committee of public accounts, militia clothing, contracts for, discussed.—March 20.

Commons, bill to permit foreign vessels to aid vessels wrecked or disabled in Canadian waters passed.—March 20.

Commons, Haggarty's bill to amend civil service act passed, Customs' amendment act, Hon. Mr. Bowell's resolution passed, North West Mounted Police, pensions for, resolution passed.—March 21.

Commons, cost of legislation, committee appointed to enquire into. The country's defences enquired into, the Forster's bill passes.—March 22.

Senate, bill of divorce for relief of George McDonald Bagswell passes third reading.—March 22.

Commons, Railway Committee, Canadian Pacific Bill passes.—March 22.

Commons, Fisheries, renewal of *modus vivendi* and Behring Sea question discussed.—March 26.

Commons, Jesuit Act, Col O'Brien moves his resolutions.—March 26.

Commons, Jesuit's Estates Act, discussion, continued speeches of Mr Dalton McCarthy and Sir John Thompson.—March 27.

Public Accounts Committee, military clothing. Evidence of Captain Bennett, Mr. Wilby and Lt.-Col. Houghton.—March 28.

Commons, Jesuit's Estates Act, Col. O'Brien's resolution defeated.—March 28.

Senate, Mr. Kirpatrick's wrecking bill defeated, Mr. Abbott's bill for expropriating land for public purposes passed.—March 28.

Senate, Railway Committee, Ottawa and Morrisburg Railway, bill incorporating same defeated.—March 28.

Commons, Committee of supply, maintenance of Rideau Hall.—March 29.

Senate, Fishing interests in Behring Sea discussed, Intercolonial Railway management debated.—March 29.

Canadian Manufacturers Association annual meeting at Toronto.—March 7

Canal tolls, Canadian, Cabinet decides to re-impose last year's rates for coming season.—March 2.

Carolina North, Negro exodus assuming serious aspect in.—March 11.

Carolina North, negro exodus from, mass meetings being held to form colonization of negroes in Arkansas.—March 18.

Cats wild, McLane Mountain, Wyoming County, W. Va., four boys, James and Thomas Loftus and Henry and Frank Mitchell attacked by.—March 22.

Chamberlain Joseph, M.P., in letter to his constituents says Government should present substitute for Mr. Gladstone's rejected bill.—March 20.

Chamberlain Joseph, M.P., and Cairne W. S., M.P., attend local option meeting London, Eng., and are hooded by the audience.—March 11.

Charleston, W. Va., Gen. Goff and Pres. Carr take oath of office as Governor, and demand that Gov. Wilson give up office, which he declines to do.—March 4.

Chigocto Marine Transport Company, prospectus of, issued in London.—March 18.

Chilian Government issues decree prohibiting the immigration of Chinese, but offering free passage, board and lodging to Europeans.—March 18.

CHINA.—Shanghai, English consulate burned by mob, and damage done to American consulate.—March 4.

Chin Kiang, serious outbreak at, British consulate and several other buildings belonging to Europeans destroyed, news brought by steamship "Belgic" to San Francisco.—March 9.

Chi Foo, native soldiers suspected of contemplating attack upon foreign settlement withdrawn by order of viceroy Le Hong-Chang.—March 11.

CHINA.—Continued.

Tien Tsin, despatch from, reports natives have risen on Kwang-Si frontier and killed 100 Frenchmen.—March 18.  
 Corea, interviews between Li-Hung Chang and Mr. Denny result in amicable understanding.—March 22.  
 Chi Hai Yu, missionary from, states Chinese have placarded houses of foreign residents, notifying tenants they will be massacred before long, news brought by steamer "Arabic" to San Francisco.—March 25.  
 Chinese troubles, Milwaukee, Chinese Ambassador at Washington sends word Chinese Government will insist upon full indemnification.—March 16.  
 Chinese, labor, Governor of West Prussia in view of scarcity of farm hands suggests introduction of.—March 13.  
 Cholera, Philippine Islands, 500 deaths at Zamboanga.—March 22.  
 Clesse Antoine, poet of Belgium, death of.—March 9.  
 Cleveland, Ohio, Huntington John, one of original members of Standard Oil Co., places \$200,000 in trust, the income to be devoted to a dozen charitable institutions.—March 9.  
 Cleveland, Ohio, Lake View Cemetery Association not first bondholders it is unable to raise the interest on its bonds.—March 7.  
 Collieries, Pittsburg, Pa., notices posted at, notifying men of suspension of six weeks.—March 25.  
 Coal, Anthracite Companies of Pennsylvania arrange plan for regulating coal trade during the year.—March 20.  
 Coal, New York, representatives of great companies meet and reduce prices.—March 12.  
 Coal, Cumberland Coal and Railway Co., R. G. Leckie resigns managing directorship.—March 13.  
 Coal-Lake, Coal Dealers Association meet at Cleveland and coplet mean organization.—Feb. 24, rep. March 2.  
 Colonial Institute, London, Eng., celebration of twenty-first anniversary.—March 14.  
 Commercial Union, resolutions fail to pass in United States Senate.—March 4.  
 Connecticut Legislature, House passes bill prohibiting use of tobacco for smoking by minors under 16.—March 14.  
 Contract labor law, Mr. Grace, special agent of United States Treasury department at Niagara frontier, to see it enforced.—March 11.  
 Copper syndicate, France, how they expect to get rid of their large stock, from *New York Herald's* Paris special.—March 7.  
 Copper at London, Eng., Metal Exchange closes at £5.5 a fa. of £17 since the previous day, and £20 on the week.—March 8.  
 Copper, London, England, large business done in G. M. B's. quoted at £50 to £51.10s cash.—March 11.  
 Copper Syndicate, London, Eng., agents of, fail to meet engagements, and force sale of 150 tons of copper.—March 18.  
 Corea and China, interviews between Li Hung Chang and Mr. Denny result in amicable understanding.—March 23.  
 Cornell University, New York, Association, annual dinner of Prof. Goldwin Smith, speech of.—March 28.  
 Corinth Canal, work on, suspended, owing to Paris financial crisis.—March 13.  
 Counterfeiters, Conway Co., Ark., Martin Thorp and Wm Garner, leaders of extensive gang, arrested.—March 7.  
 Customs, Beaver Harbor, N.B., seaman "Wm. H. Foye" seized for violation of Customs law.—March 5.  
 Customs, Booth Bay, Me., British Schooner "Gleaner," from St. John for New York, seized for non-curve.—March 8.  
 Customs, Grand Manan, N.B., American fishing schooner "W. H. Foye" seized for landing a dore without reporting or paying duty.—March 20.  
 CRIMES.—Suicide, France, Rochereau M. Denfert, director of Comptoir d'Escompte, Paris, asserted suicide of.—March 4.  
 Absconders, New Brunswick, N.J., Dexter Edward, deputy postmaster.—March 20.  
 Absconders, Chicago, Charlie Faw, clerk for Sing Kee, Chinese merchant, disappears with employer's savings.—March 25.  
 Absconders, New York, Henry Hardie brought before Judge Townsend at Halifax, and discharged and re-arrested on another charge.—March 25.  
 Bigamy, Toronto, Irwin Alexander tried and sentenced.—March 11.  
 Defaulters, Lynn, Mass., Edgar Swan, paying teller of National City Bank, brought before Commissioner Hallitt.—March 16.  
 Defaulters, New Brunswick, N.J., Dexter Edward, deputy postmaster.—March 20.  
 Defaulters, Philadelphia, Craven Robert, secretary and treasurer of Philadelphia, Wellington and Baltimore Railroad Company.—March 22.  
 Forgery, New York, Henry Hardie arrested at Halifax.—March 22.

CRIMES.—Continued.

Forgers, New York, Henry Hardie brought before Judge Townsend at Halifax, and discharged, and re-arrested on another charge.—March 25.  
 Manslaughter, Cornwall, Ont., Bogart Wm., acquitted of killing Huttie.—March 15.  
 Manslaughter, Hartford, Conn., Thuer Alex. and Reily Amos E., engineers at Park Central Hotel, committed for trial to the Supreme Court.—March 12.  
 Robbery, Memphis, Talbot Charles, clerk of Gayoso Hotel, who stole \$125,000 worth of diamonds from Panny Daveport, pardoned by Governor Taylor, of Tennessee.—March 20.  
 Robbery, Denver, Col., Mr. Moffatt, president of first National Bank, compelled to make out and pay cheque for \$21,000.—March 20.  
 Seduction, Toronto, John Archibald Watson and Miss Alice Kirby, jury bring in verdict for \$5,000.—March 28.  
 Suicide, Vienna, Signor Romano, a painter of some note, commits suicide.—March 12.  
 Suicide, Madrid, Ronald Pensonby, supposed to be Richard Pigott, shoots himself.—March 1.  
 Crofter, Emigration Committee, report of, discussed in British House of Commons.—March 20.  
 Cuba, in Spanish Senate, Minister of Interior said Government had no knowledge of scheme to sell Cuba to United States.—March 20.  
 Customs, U. S., Ogdenburg, Treasury department affirms action of collection of customs exacting fee on cars of Rome, Watertown and Ogdenburg Railway brought by ferry steamer.—March 30.  
 Customs, Vancouver, raid on China Town, seizure of Chinese wine and Manila cigars.—March 22.  
 Dairy Commission, wholesale Butter, Cheese and Egg Dealers Association of New York petition senate to appropriate \$100,000 for maintenance of dairy commission.—March 23.  
 Dakota, Prairie fires, much damage done by.—March 30.  
 Dakota, President nominates Arthur C. Mallette to be Governor, and Luther B. Richardson to be Secretary.—March 12.  
 Dakota, deplorable state of affairs amongst the farmers shown by the *Fargo Argus*.—March 21.  
 DEATHS.—Bartlett Sidney, the Nestor of the Suffolk Bar, at Boston.—March 6.  
 Booth Miss Mary L., Editor of *Harper's Bazaar*, New York.—March 5.  
 Bright Rt. Hon. John, M. P., at Rochdale, Eng.—March 27.  
 Buckingham and Chandos Duke of.—March 27.  
 Clesse Ant sine, poet of Belgium.—March 9.  
 Coen Rev. Father, of Woodford, Ireland, agitator of the land question.—March 6.  
 Davis Rear Admiral, retired, dies at Washington.—March 12.  
 De Gaspé Rev., curé of Lévis, Quebec.—March 10.  
 Deguistolle Francois V., private secretary of Gen. Montellot, who was with Napoleon at St. Helena, at Storm Lake, Ia.—March 3.  
 Dugas Mr. Firmin, ex-M.P. for Montcaim, death of.—March 18.  
 Erickson John, Civil Engineer, at New York.—March 7.  
 Frazer Lord, Judge of Outer House of Scotch Court of Session, death of.—March 24.  
 Gladstone Sir Thomas.—March 20.  
 Graham Mr. Ketchum, ex-M.P. for West Hastings, at Sydney, Ont.—March 9.  
 Hall Samuel Carter, death of.—March 18.  
 Howard Dr. R. P., Dean of Medical Faculty of McGill College, Montreal, death of.—March 28.  
 Heegan Thomas, of Jumata township, Pa., aged 108 years.—March 28.  
 Jaurès Admiral, French Minister of Marine.—March 13.  
 Kennedy Mr. H. C., editor and publisher of *Morrisburg, Ont., Courier*.—March 29.  
 McCormick Rosanna, eccentric woman, dies at Jordan's White Sulphur Springs, Pa.—March 24.  
 McKay Mr. Hugh, prominent citizen of Regina.—March 24.  
 Matthews Justice Stanley, at Washington.—March 22.  
 Maginnis D. J., actor, at Boston.—March 18.  
 Meier Mr., founder and manager of North German Lloyd Steamship Company.—March 11.  
 Prince Moritz of Hawaii.—March 25.  
 Peacock Richard, M.P. for Gordon division of Lancashire, England.—March 2.  
 Rochereau M. Denfert, at Paris.—March 5.  
 Schonvaloff Count Peter, death of, at St. Petersburg.—March 22.  
 Ellbaech Louis, French novelist.—March 16.  
 Viato Rev. W. S., of Quebec.—March 10.  
 Williamson Isaac P., millionaire philanthropist, at Philadelphia.—March 7.  
 Williamson J. V., will of, admitted to probate at Philadelphia.—March 11.

- Dequisselle Francis V., private secretary of Gen. Montellot, who was with Napoleon at St. Helena, death of, at Storm Lake, Ia.—March 3.
- Denmark, Rigsgad, Butterfield's claim, announcement that British Minister at Athens would act as arbitrator between United States and Denmark.—March 6.
- Denmark, Rigsgad, committee of Lower House advise ratification of convention between Denmark and United States providing for arbitration of claim of Mr. Butterfield against Denmark.—March 23.
- Denver, Col., James Flannigan, alias Jack the Kisser, &c., sent to goal for 18 months.—March 29.
- Diphtheria black, Gallitzen, Pa., epidemic of.—March 9.
- Diphtheria, Mono Centre and Helessey, Ont., outbreak of.—March 11.
- DIPLOMATIC.—Germany, Austria, Count Von Waldzerer to succeed Prince Henry of Reuss as German Ambassador to Vienna.—March 2.
- France and Germany, French Ambassador's dinner to Emperor William at Berlin.—March 9.
- Great Britain and United States, Sir Julian Pauncefote's appointment semi-officially confirmed in London.—March 1.
- Great Britain and United States, Queen approves of appointment of Sir Julian Pauncefote.—March 11.
- United States, President sends nominations to Senate.—March 11.
- United States, President Harrison receives the members of the diplomatic corps.—March 14.
- United States and France, Whitelaw Reid, of New York, appointed to be United States Minister to France.—March 19.
- United States and Germany, Murat Halstead, nominated by President as Minister to Germany.—March 23.
- United States Murat Halstead as Minister to Germany, nomination not confirmed by Senate, but it confirms Loring to Portugal, Lincoln to Great Britain, Thornycroft to Russia, Ryan to Mexico, and Egan to Chili.—March 30.
- United States and Great Britain, Lincoln, Robert T., appointed Minister.—March 28.
- United States, nomination of F. D. Grant to Austria-Hungary sent to Senate.—March 20.
- Distillers, rebate on grain brought from foreign countries. Farmers at Kingston, Ont., adopt resolution urging Parliament to rescind order-in-council granting such rebate.—March 12.
- Divorce, Gibbons Card., interviewed thereon, at Baltimore, by New York *Herald's* correspondent.—March 16.
- Divorce, London, Eng., Donegal Marchioness of, brings suit against her husband for cruelty and desertion.—March 21.
- Divorce, Ottawa, Middleton divorce case before the Senate.—March 20.
- Divorce, Bagswell, George McDonald, third reading of bill passes in Canadian Senate.—March 22.
- Divorce, McCombe James C., millionaire, applies for, on ground of incompatibility of temper.—March 23.
- Divorces, New Jersey, annual report of Dr. E. M. Hunt, secretary of Board of Health, Trenton, treats fully of same.—March 22.
- Divorce, New York, Bishop Mrs. Helen G., obtains absolute divorce against Washington Irving Bishop, the mind-reader.—March 27.
- Drexel A. J., purchases the Lonella Mansion at Wayne, Pa., and selects trustees and managers for the Drexel Industrial College for Women.—March 11.
- Duels, Emperor Willinn refuses to grant pardon to duellist who shot Dr. Halle.—March 8.
- Duel, Servia, proposed duel at Belgrade between M. Belimara Kovics, one of the Regents, and Nuhokovics, Chief of Staff, prevented by ex-King Milan.—March 14.
- Duel, Count Hoyos, trusted friend of late Crown Prince Rudolph, fights and shoots Count Balinzi, uncle of late Baroness Vetseni, duel fought in South of France.—March 27.
- Duel, Paris, M. de Loulay and Gernalt Richard fight. The former slightly wounded.—March 23.
- Duel, Rome, Italy, Deputy Cavalotti slightly wounds Signor Corveto, under-secretary of war department.—March 23.
- Dugas Mr. Firmin, ex-M.P. for Montcahn, death of.—March 18.
- Dundee, Socialist riot at.—March 21.
- Earthquake, Spain, strong shocks felt at Alhama and Grenada.—March 26.
- Earthquake, Guayaquil, several sharp shocks felt at.—March 4.
- Earthquake shocks in different portions of Pennsylvania and Maryland.—March 8.
- Earthquake, Italy, shock of, at Aquila.—March 9.
- Earthquake, Smyrna, shock felt at.—March 21.
- ECCLIESIASTICAL.—Ireland, The Pope, pastoral letters read in the Catholic churches express sympathy with the Pope's position.—March 3.
- Baltimore, Md., Cardinal Gibbons receives from Pope letter in reply to letter of condolence which Cardinal sent him.—March 16.
- Divorce, Cardinal Gibbons interviewed at Baltimore by New York *Herald's* correspondent.—March 10.
- ECCLIESIASTICAL.—Continued.
- England, Trial of Right Rev. Edward King, Bishop of Lincoln for ritualistic practices, defendant's counsel read extracts from Canon law.—March 12.
- Ireland, death of Father Coen, of Woodford, agitator of the land question.—March 6.
- Kingston silver jubilee of Superior of House of Providence celebrated.—March 25.
- Levis, Quebec, death of Rev. Curé de Gaspié.—March 10.
- Pope replies in letter to Cardinal Gibbons to one sent by American Archbishops as to liberty and right of Apostolic See.—March 30.
- Rome, Father Agostino preaches at church of San Carlo, riot ensues, many arrests made.—March 27.
- Rome, Bomb explodes in San Carlo Church, while Father Agostino preaching.—March 31.
- Rome, Pope raises to the cardinalate Monsignors Bianti, Lauranzi, Panuntelli and Christofori.—March 14.
- Rome, The Pope celebrates 79th anniversary of his birth.—March 2.
- Rome, American pilgrims received by the Pope.—March 18.
- Rome, Bishop Neave of Washington presents Miss Caldwell, benefactress of Washington University, to the Pope.—March 16.
- Queber, death of Rev. W. S. Viado, of Anglican Church.—March 10.
- Sherman Thomas Ewing, son of General Sherman, becomes a member of the Society of Jesus.—March 14.
- Toronto, Jesuits, Wilo Rev. Dr., takes up challenge of Whelan Rev. Father, to prove that oath of Jesuits sanctioned the doing of wrong that good may come of it.—March 3.
- Toronto, New Surgical Hospital for women, under control of Anglican sisterhood opened by Bishop of Toronto.—March 30.
- Washington University, Pope issues brief, approving statutes of.—March 13.
- Eighty Club, London, Eng., Earl Spencer and Mr. Parnell, guests of.—March 8.
- EGYPT.—Great battle on the White Nile, Emin Pascha defeats expedition sent against him by Khalepa Abdullah, news brought to Cairo by deserters from Khartoum.—March 1.
- Messenger arrives at Wady Halfa, and reports battle between followers of Senoussi and Mahdists at Sinnan, former victorious, 2 Mahdist chiefs killed.—March 16.
- Emin Pascha scores a victory, and kills 6000 Mahdists in the Soudan, news brought to Cairo by Mohammed Beravi.—March 24.
- Victory of Senoussi at Sinnan, report confirmed by despatch received at British Foreign office.—March 25.
- ELECTIONS.—Barnsley, England, Lord Compton, Gladstonian, returned to the House of Commons.—March 12.
- Chiselhurst, N. J., school trustees.—March 19.
- England, Enfield divisions of Middlesex, Captain Bowles, Unionist Candidate, returned.—March 29.
- England, Gorton division of Lancashire, Richard Peacock, Gladstonian returned.—March 23.
- England, Kennington division of Lambeth, Mr. Beaufoy, Gladstonian, elected.—March 15.
- Haldimand, return of Mr. Cotter protested.—March 11.
- Electricity executions by New York, final experiments by New York State authorities.—March 12.
- Electric Light, Edison Electric Light Co. and United States and Westinghouse Companies, Commissioner of Patents, Ottawa, decides against Edison Company.—March 7.
- Electric lighting, New York, U.S. illuminating company passes into the control of Westinghouse Electric Light Company.—March 20.
- Emigration, announcement made in British House of Commons that Government intends appointing committee to enquire into subject.—March 19.
- Emin Bey, Dr. Peters' expedition for relief of German Government decides to prevent it from proceeding into the interior of Africa.—March 2.
- Emin Pascha scores a victory and kills 6000 Mahdists in the Soudan, news brought to Cairo by Mohammed Jeraivi.—March 24.
- Ericson Coast Defence Company, certificate of incorporation filed in New York.—March 23.
- Erickson John, the Civil Engineer, death of, at New York.—March 7.
- FAILURES.—Boston, Gould Henry A., & Co., dealers in dyestuffs.—March 1.
- Antioch Company, meeting for voluntary liquidation convened at London, Eng.—March 14.
- Barrington, Mass., Adams Frank W., proprietor of Glondale woollen mills.—March 25.
- Boston, Cummings E., & Co., leather dealers.—March 27.
- Boston, North Chas. II., & Co., pork packing firm.—March 19.
- Columbus, Ohio, The Mhooning National Life Association.—March 6.
- England, Mandeville Viscount, eldest son of Duke of Manchester.—March 6.

THE INDEX OF CURRENT EVENTS.

FAILURES.—Continued.

France, Tavanda & Co., bankers of Lemans.—March 16.  
 London, Eng., Maudeville Lord, heir to Duke of Manchester, pronounced bankrupt.—March 28.  
 Montreal, Thurston Mr. J. D., wholesale boot and shoe manufacturer.—March 29.  
 Mimico, Toronto, Burgess Wm., dealer in canned goods, arrested at Buffalo, N. Y., on charge of defrauding his creditors.—March 15.  
 New York, Demott & Durant, stock brokerage firm.—March 20.  
 Ottawa, Brown ex-Ald., arrested on charge of attempting to defraud his creditors.—March 22.  
 Quebec, begin shoe manufacturing establishment.—March 16.  
 Quebec Shoe Company.—March 21.  
 Reading, Pa., Iron Works Company.—March 5.  
 Reading, Pa., Iron Works, meeting of creditors, report of committee on appraisement.—March 14.  
 St Leonards, Victoria County, N. B., Hamilton George V., general trader and lumberman.—March 22.  
 Toronto, Christie, Kerr & Co., lumber firm.—March 5.  
 Toronto, Risley and Kerrigan, meeting of creditors, estate ordered to be sold by auction.—March 5.  
 Toronto, Risley & Kerrigan, wholesale merchants, stock disposed of to Samuel Benjamin & Co.—March 15.  
 Farms experimental, report upon, to Canadian Government.—March 9.  
 Farmers, Kingston, Ont., adopt resolution urging Parliament to rescind order-in-council granting rebates to distillers on grain brought from foreign countries.—March 12.  
 Fisheries Question, Canadian Government decides to renew the issue of license to American fishermen under *modus vivendi*.—March 25.  
 Fisheries, renewal of *modus vivendi* discussed in Canadian House of Commons.—March 26.  
 Fisheries, Newfoundland, fishermen returning to Gloucester, Mass., from Fortune and Placentia Bays, say cutters patrolling and every port strictly guarded.—March 14.  
 Flood James C., will of, filed at Redwood City, Calif.—March 4.  
 Flour, St. Louis, millers of winter wheat holding secret meetings for purpose of forming combine to control the output of flour.—March 7.  
 Flour, freight on, Chicago, Burlington and Northern Road gives notice at meeting of North-Western division of West Freight Association to reduce rate on.—Feb. 28, rep. March 2.  
 FRANCE.—Armentières, workmen on strike attack the factories, soldiers called out.—March 7.  
 Academy, Duc d'Annale, elected director of.—March 18.  
 Admiral Krantz appointed Minister of Marine.—March 16.  
 Alsace-Lorraine Society hold meeting at Paris to decide whether to give banquet in honor of M. Antoine. Unpropitious proceedings.—March 27.  
 Antoine M., recently member of Reichstag for Metz, issues farewell address to his constituents.—March 16.  
 Antoine M., enthusiastically greeted on his arrival at Paris.—March 29.  
 Antoine M., professes hostility to Gen. Boulanger, since the latter abandoned the Revanche policy.—March 21.  
 Antoine M., banquet given to, at Paris, and he gives advice as to discussions.—March 22.  
 Boulanger Gen., denounces, at reception at Paris, M. Tirard for striking down league of Patriots.—March 3.  
 Boulanger, officers ordered not to salute or recognize him in the Bois de Boulogne.—March 6.  
 Boulanger Gen., in letter to electors of department of the North announces the circumstances requiring him to represent the department of the Seine.—March 17.  
 Boulanger, on journey from Paris to Tours, meets with enthusiastic greetings.—March 17.  
 Boulanger, Ministry decides to prosecute.—March 29.  
 Cabinet decides to abandon scheme for creation of a minister of the colonies.—March 12.  
 Chamber of Deputies, suppression of the patriotic league, the Government sustained in its action.—March 2.  
 Chamber of Deputies, Panama Canal. The Government refuses aid to.—March 7.  
 Chamber of Deputies, Amnesty to persons imprisoned under laws dealing with strikes, public speaking and press offences, proposal for immediate discussion negatived.—March 9.  
 Chamber of Deputies, Duke d'Annale revocation of banishment of, brought by M. Pelletan. The Government's conduct endorsed.—March 9.  
 Chamber of Deputies, patriotic league, Government authorized to prosecute leaders of.—March 11.  
 Chamber of Deputies, deputies belonging to patriotic league to be presented, General Boulanger defiant challenges to fight duels.—March 14.

FRANCE—Continued.

Chamber of deputies, Patriotic League, M. Laguerre attacks M. Constans, Minister of Interior, exciting scene in the Chamber.—March 16.  
 Chamber of deputies, financial crisis discussed, motion that Government take steps to ascertain who were responsible for crisis, and to make law respected, adopted.—March 21.  
 Chamber of deputies, the copper collapse discussed, authors of syndicate described as ruined.—March 21.  
 Chamber of deputies, distribution of sewage of Paris on the plain of Acheres, bill passed for.—March 25.  
 Chamber of deputies, treasurer, general department, resolution adopted in favor of introduction of bill to organize department.—March 26.  
 Chamber of deputies, Rye, bill passed doubling import duties on rye, and adding 5 francs per hundred weight to duty on rye meal.—March 28.  
 Chamber grants credit of 20,000,000 francs for erection of memorial of revolution.—March 28.  
 Chamber of deputies, slanderous press attack on public officials, bill dealing with, urgency voted for.—March 30.  
 Comptoir d'Escompte de Paris, six directors announce readiness to pay on demand all moneys deposited with the company.—March 6.  
 Comptoir d'Escompte de Paris, the Bank of France advances a hundred million francs to.—March 8.  
 Comptoir d'Escompte, Shanghai branch compelled to suspend until supplies arrive.—March 11.  
 Comptoir d'Escompte, Minister of Finance appoints two experts to ascertain exact position of.—March 14.  
 Comptoir d'Escompte, M. Michard appoints liquidator, an emission nominated to compile statutes of a new Comptoir National d'Escompte.—March 19.  
 Comptoir d'Escompte, twenty million francs subscribed on condition Bank of France subscribes a million.—March 24.  
 Comptoir d'Escompte, Tribunal of Commerce decides there is no ground for dissolution, but nominates provincial administrators.—March 24.  
 Comptoir d'Escompte, report of Trustees appointed by Paris Tribunal of Commerce.—March 28.  
 Comptoir d'Escompte directors appear before M. Friet, examining Magistrate.—March 30.  
 Copper syndicate, Société des Métaux gives notice of its inability to take deliveries of copper from the mines.—March 19.  
 Deputation from Boulogne visits Boulanger, and presents him with sword of honor.—March 5.  
 Duc d'Annale has interview at Paris with President Carnot.—March 12.  
 Financial crisis, seventy-five million francs taken out from Bank of France, in addition to hundred million francs advanced to Comptoir d'Escompte.—March 16.  
 Financial crisis, Financiers meet, M. Rouvier makes appeal which meets with success.—March 17.  
 Havre, M. Antoine given a banquet at, he protests against anything approaching dictatorship for France.—March 24.  
 Kneib M., formerly police inspector at Avricourt, sent to prison for 2 years as a German spy.—March 25.  
 M. de Loulay and Gerault Richard fight duel at Paris, former slightly wounded.—March 23.  
 Newfoundland, deputation urges Premier Tirard and M. Chamberlain, French minister of foreign affairs to deal with neutralization of fishing season.—March 25.  
 obtains permission from Germany to transfer remains of Generals Carnot and Mareau to France.—March 23.  
 Paris, Bank panic, great meeting of bankers presided over by M. Rouvier sits at Ministry of Finance.—March 8.  
 Paris, Eiffel tower inaugurates, Premier Tirard delivered an oration.—March 31.  
 Patriotic League, Paris, 5,000 letters seized in the offices of.—March 4.  
 Patriotic league, public presentation at Paris sends to Minister of Justice an indictment under secret societies law against officers of patriotic league.—March 9.  
 Patriotic league, Manifesto, published by MM. Naquet, Laguerre, Laisant and Turquet, in which they say "Parliament is already doomed."—March 11.  
 Patriotic League, Paris police search houses of many members of, committee of liberal union formed, and issues manifesto protesting against Caesarism and the radicalism which produced it.—March 15.  
 Patriotic league, police make further searches in residences of members of.—March 17.  
 Patriotic league, Senator Naquet and Deputies Laguerre and Turquet arraigned before examining magistrate at Paris.—March 10.  
 Patriotic league, *Journal des Debats* says Government abandoned prosecution of Deputy Laguerre.—March 25.

THE INDEX OF CURRENT EVENTS.

FRANCE.—Continued.

Senate passes bill constituting itself a high court of justice in cases of plots against the state.—March 29.  
 Société des Métaux, M. Moreau appointed Judicial liquidator of the Society.—March 21.  
 Vaselet's exhibit of busts prohibited by Paris Exhibition authorities, because bust of Boulanger in the collection.—March 4.  
 Frazer Lord, Judge of Outer House of Scotch Court of Session, death of.—March 28.  
 Freight, West Freight Association, Chicago, Burlington and Northern Road gives notice of its intention to reduce rate on flour.—Feb. 28, rep. March 2.  
 Fur sales, Hudson Bay Company, satisfactory prices, London, Eng.—March 27.  
 Gerh. Jt Prof., eminent physician of Berlin, entertained at dinner in London, Eng., by Sir Andrew Clarke.—March 20.

GERMANY.—

laden-Baden estates of the late Duchess of Hamilton sold to land speculator.—March 2.  
 Antoine M., member of Reichstag from Metz, who was expelled-Germany, resigns his seat.—March 14.  
 Antine M., recently member for Metz in Reichstag, issues farewell address to his constituents.—March 16.  
 Anti-Socialist law, Bavarian Ministerial Council constructs representatives in Federal Council, to oppose passing of law.—March 30.  
 Berlin charges brought against Dr. Weiz, member of West Prussian Diet, with fraudulently appropriating 104,000 marks.—March 23.  
 Berlin *Volk's Zeitung* suppressed by Government under Socialist law.—March 18.  
 Berlin, memorial service in honor of late Emperor William.—March 10.  
 Bismarck Count Herbert, starts for London, the German papers say to settle the rapprochement between England and Germany.—March 21.

Charlottenburg, editor of local paper, sentenced to imprisonment for libelling Bismarck.—March 20.  
 French Ambassador's dinner to Emperor William.—March 9.  
 Government orders manufactory for steel rifles to be erected at Spandau.—March 22.  
 Hamburg, young officer in German navy, son of Herr Goebel, shoots himself and Mülle, Langener, an opera singer, his minorera.—March 22.  
 Duellist who shot Dr. Halle, Emperor William refuses to grant pardon to.—March 8.  
 Monument to Emperor Frederick on battlefield of Werth, Emperor William sanctions the project.—March 4.  
 Reichstag, Artillery, supplementary estimates for increase and re-organization of, discussed.—March 15.  
 Reichstag, aged workmen's insurance bill, Bismarck denies he is dying.—March 29.  
 Samoan difficulty, Government issues White book on.—March 22.  
 Swords and rifles in large quantities ordered by Government.—March 25.  
 United trades guild, central committee of, received by Emperor William, and speaks as to object of his European tour.—March 16.  
 Zurich, student killed and others wounded while making bombs, many arrests made.—March 8.

Gladstone Mr. W. E., writes letter to candidate at Kensington, Eng., that struggle regarding Ireland will terminate in his favor.—March 14.  
 Gladstone Sir Thomas, death of.—March 20.  
 Gold, Big Sandy and Montana, excitement caused by development of gold mines in Sweet Grass Hills, special despatch *N. Y. Tribune*.—March 18.  
 Gold bars, amounting to \$1,250,000 taken from assay office New York for export to Europe.—March 15.  
 Gold Fields, Santa Clara mining districts, 1,500 people in Santa Clara mining district, rich finds.—March 8.  
 Gold Fields, South Carolina, contradictory reports regarding the diggings.—March 13.  
 Gold Fields, California, New York *Wacht's* correspondent returns from Santa Clara gold region and describes California gold excitement as a delusion and a fraud.—March 14.  
 Gold Fever, California, James Kerraner of Los Angeles returns from the camp and gives account of successful finds.—March 8.  
 Gold Mine, Dufferin, Salmon River, Halifax County, N.S., sold by auction for \$145,000.—March 14.  
 Gold mines, Santa Clara, Lower Cal., correspondent of *San Francisco Examiner* says they are a "glittering delusion."—March 28.  
 Gold, New York, one million dollars ordered for shipment to London.—March 22.  
 Gold, Queen's county, N. S., bonanza lead struck in Molega Gold Mining Company's areas.—March 25,

Gold, Townsend, Mont., discovered in the bluffs on Missouri river.—March 23.  
 Gould Jay, interviewed on Interstate law by *New York Tribune*.—March 23.  
 Gould Mr. Jay, interviewed at St. Louis on the railroad situation.—March 12.  
 Graham Mr. Ketchum, ex M.P.P. for West Hastings, death of. at Sydney Ont.—March 9.  
 Grain rates, Grand Trunk Railway issues notice as to rates to Montreal from Toronto and points east.—March 26.  
 Greece, Government protests against Austria's lottery prohibition.—March 25.  
 Greece, Chamber of deputies votes dowry of \$80,000 to Princess Alexandra and \$108,000 to build residence for Duke of Sparta.—March 26.  
 Griffin W. G., American Consul at Sydney, N.S.W., arrives at San Francisco, and is interviewed as to the trade relationship of New South Wales to United States.—March 20.

Hall Samuel Carter, English writer, death of.—March 18.  
 Hanau, Prince Moritz of, death of.—March 25.  
 Harrison President, on Civil Service Reform, Cleveland *Leader's* Washington correspondent telegraphs as to interview with President by party of congressmen.—March 12.  
 Harrison President, receives the members of the diplomatic corps.—March 14.  
 Hartford, Conn., Thuer Alex. and Reiley Amos E. engineers at Park Central Hotel, committed for trial for manslaughter to the Supreme Court.—March 12.  
 Hartington Lord, addresses meeting on Irish affairs at Islington, London, Eng.—March 13.  
 Hartington Lord, addresses Council of Liberal Unionists on prospects of Home Rule.—March 22.  
 Hawaiian Islands, proposed annexation to United States, New York *Herald* interviews Minister of Hawaiian Islands at Washington thereon.—March 16.

HAYTI.—Legitimate's forces defeat Hyppolite's Army, towns in North captured, General Gabien killed, Gen. Nzeze captured. Advice brought by steamer "Audes" to New York.—March 6.  
 Legitime sends telegrams to European Governments announcing rebellion crushed, and demanding recognition of his Government.—March 7.  
 Legitime's warship, the "D. salines" arrives off Gonaves and is fired upon by two forts. The Southern army burns the town of Grand Soline and commits outrages on females.—Reported March 13.  
 Legitime meets with success in department of Lartibonite, Army of South captures province of Iron.—reported March 28.

Steamer "Caroline Miller" arrives at New York, and reports that twelve of Legitime's soldiers taken prisoners by Hippolyte shot in public square at Cape Haytien.—March 15.  
 Holland, Minister Heemskerck appointed regent, reported at the Hague.—March 22.  
 Holland, the Queen undertakes temporarily the duties of regent.—March 25.  
 Holland, Lower House, Prime minister announces Cabinet decides that the King is incapacitated from carrying on Government.—March 26.  
 Honorable Artillery Company, London, Eng., Queen restores to the company its ancient privileges.—March 16.  
 Horses, Cambridge City, Md., Luckey, Carmony sale closes at.—March 22.  
 Horses, "Prince Wilkes" owned by George A. Slingerly, of Philadelphia, sold in New York for \$30,000 to J. R. Hubbard.—March 25.  
 Howard Dr. R. P., Dean of Medical faculty of McGill College, Montreal, death of.—March 28.  
 Hudson Bay, fur sales, satisfactory prices, London, Eng.—March 27.  
 Hungary, Herr Von Tisza, prime minister, tendered reception by Liberal Club at Pesth, and receives an ovation.—March 13.  
 Hungary, Pesth, rioting renewed, 100 persons arrested, Prime Minister Tisza receives full powers from Emperor to stop outbreak.—March 21.  
 Hungarian diet, Tisza Premier, arrives, riotous scenes in the Chamber.—March 20.  
 Hungary Diet, Herr Orlean denounces the police for interfering with students' demonstrations.—March 22.  
 Hungary, Pesth, rioting renewed, military called out, several persons arrested.—March 25.  
 Hungary Diet, Lower House, army bill considered, motion against second year's service for volunteers rejected.—March 26.  
 Immigrants, New York, ten Arab immigrants shipped back to Europe.—March 23.

IMPERIAL PARLIAMENT.—House of Commons, Irish debate, Mr. Gladstone replies to Mr. Chamberlain.—March 1.  
 Ireland, Mr. Morley's amendment to the address rejected.—March 1.  
 Commons, Robert Gent Davis, M.P., resigns his seat.—March 4.  
 Commons, closure carried on the Queen's speech.—March 6.

INDI  
 Ince  
 Indi  
 India  
 Inlan  
 Insan  
 Insnr

## IMPERIAL PARLIAMENT.—Continued.

Commons, Navy, Lord George Hamilton asks for twenty-one million pounds to be spent on new vessels.—March 7.

Commons, Samoa, Sir James Ferguson states England has no right to interfere in the matter.—March 7.

Commons, Mr. Bradlaugh's motion to expunge from the records the particulars of his expulsion from the House in 1889 defeated.—March 8.

Commons, Army estimates, Mr. Stanhope says that owing to increased protection afforded the colonies, Government had provided for increase in colonial contributions.—March 11.

Commons, Irish Secretary states there is £18,000 unspent of Parliamentary grant for emigration from congested districts of Ireland.—March 11.

Commons, Naval, Lord George Hamilton announces that Australia has promised to give £35,000 annually for ten years towards building war ships, and to fully maintain vessels when completed.—March 12.

Commons, Samoa, Government questioned as to conduct of German Consul Knapps.—March 12.

Commons, political prisoners, Mr. O'Connor's bill relative to, rejected.—March 13.

Commons, Trusts discussed in connection with salt syndicate.—March 15.

Commons, Parnell *Times* case, Home Secretary questioned as to action of Anderson, an official of the Home office.—March 15.

Commons, Emigration, announcement made that Government intended to appoint a committee to enquire into subject.—March 19.

Commons, closure, Mr. Smith gives notice he will exercise it to force on the estimates, discussion led by Sir W. V. Harcourt thereon.—March 19.

Commons, Ireland, Gladstonian attack on Ministers, opening of campaign.—March 19.

Commons, supply bill discussed till 4 a.m.—March 19-20.

Commons, Crofter emigration, committee report of, discussed.—March 20.

Commons, Parnell *Times*, Home Secretary announces that council for Parnellites would be allowed same freedom of access to convicts as granted council for *Times*.—March 20.

Commons, Postmaster announces Government will lay a submarine cable between Bermuda and Halifax.—March 21.

Commons, Chief Secretary for Ireland's salary, stormy discussion on Mr. Bradlaugh's motion to reduce, rejected.—March 21.

Commons, Seagrave Captain, who commanded convicts in Mitchells-town riots in 1887, previous record of, announced by colonial secretary, a scene of disorder follows.—March 21.

Commons, Sir Richard Webster, Attorney General, sustained by small majority.—March 22.

Commons, Parnell *Times*, the Pigott letters, Sir Charles Russell upholds the veracity of Sir Richard Webster.—March 25.

Commons, slave trade, resolution adopted declaring Government should ascertain whether powers are willing to meet in conference to discuss the question.—March 26.

Commons, Behrings Sea, question asked as to three sealing ships arrested in 1887.—March 28.

Commons, Bright the late Hon. John, Mr. Gladstone pronounces eulogy upon.—March 29.

Lords, Earl Carnarvon's bill providing for the expulsion of peers for discreditable conduct rejected.—March 21.

Lords, John Bright, Lord Salisbury's exordium on.—March 28.

Morocco Sultan of, and England, announcement made that British channel squadron gone to Tangier.—March 19.

Samoa, blue book on Samoan affairs issued.—March 20.

INDIA.—Cashmere, discovery of plot against the life of British resident, the Maharajah offers to abdicate.—March 9.

Cashmere, Maharajah of, official enquiry ordered into alleged conspiracy by, to poison British resident.—March 11.

Incendiarism, York, Pa., incendiaries arrested at.—March 20.

Indian troubles, Semite Indians, affray among, in the Everglades, eight Indians killed.—March 2.

Indians, Arizona, Chitcheum, a rebellious chief and 15 warriors entrenched, 14 miles north of San Carlo's agency and defying military authorities.—March 25.

Indians, Major McGibbon, of Indian department, visits Winnipeg, and makes excellent reports concerning Indians.—March 25.

Inland Revenue, New Haven, Ct., 11,000 pounds of oleomargarine seized a factory of N. J. Nathan & Co.—March 25.

Insane, Calico, Lake Como, Leopold Landner, noted diamond merchant of Berlin, arrested.—March 8.

Insanity, Ramberg, Austria, frolic of 5 persons all insane, prayed continuously for three days and nights.—March 12.

Insurance Underwriters Canadian, convention of, at Montreal.—March 28.

Interstate commerce commission renders decision at Washington in the case of the North Western Iowa Grain and Stock Shippers Association vs. The Chicago and North Western Railway Company.—March 22.

Interstate law, Jay Gould interviewed thereon, by New York *Tribune*.—March 23.

Interstate Commerce Commission at Washington cites Grand Trunk Railway for violating law by granting rebates.—March 26.

Interstate Commerce, commission issues circular calling attention of carriers to act of Congress amending Interstate Commerce Act.—March 8.

IRELAND. Clonmel, Tanner Dr., M.P., arrives at.—March 3.

British Cabinet decides to introduce at next session of Parliament Land purchase scheme, and in 1891 Irish Local government bill.—March 29.

Clongorry, thirteen tenants evicted from their holdings.—March 28.

County Clare, Greagh Mr., a landlord and his sister fired upon while driving to Church.—March 10.

Chamberlain Mr., in letter to his constituents, says Government should present substitute for Mr. Gladstone's rejected bill.—March 20.

Emigration, Irish Secretary states in House of Commons that there are £18,000 unspent of Parliamentary grant for emigration from congested districts of Ireland.—March 11.

Father Coen of Woodford, the famous agitator of the land question, death of.—March 6.

Gladstone Mr., writes letter to candidate at Kensington, Eng., that struggle will terminate in his favor.—March 14.

Gweedore, McFadden Father, trial of, for offence under Crimes Act begun.—March 29.

Home Rule, prospects of, Lord Hartington addresses council of Liberal Unionists upon.—March 22.

Letterkenny, Father Stephens, of Falcagh, sentenced to six months imprisonment for offences under the Crimes act.—March 4.

McCarthy Justin, presides at Nationalist banquet in London.—March 18.

O'Brien Wm., M.P., British Government, abandons idea of prosecuting for conspiracy.—March 13.

O'Brien William, refuses to accept his liberty on condition imposed by Parnell *Times* commission.—March 18.

Oliphert estates, twenty-three tenants tried for resisting officers sent to evict them, and sentenced to imprisonment at Enniskillen.—March 11.

Queenstown, Doneghy Michael and wife, arrested for having revolvers and ammunition among their baggage from America.—March 10.

Tanner Dr., M.P., arrested in the smoking room of his hotel, London, Eng.—March 1.

Tanner Dr., M.P. for Cork, convicted of violation of Crimes act, and sentenced to imprisonment.—March 7.

Tipperary, Mr. O'Mahoney, editor of *Tipperary Nationalist*, sentenced under Crimes Act for intimidation.—March 20.

Townarville, County Donegal, number of tenants evicted by 300 policemen assisted by troops.—March 20.

Walsh Archbishop, sends telegram to Card. Rampolla, Papal secretary of state, instancing case of Pigott as proving that Parnellites have been misrepresented at the Vatican.—March 2.

Irish National League, British spies in America, resolution adopted urging joint action by congress of United States, as to.—March 3.

Irish World, decision of Judges in London, Eng., holds the Land League responsible for general tenacity of its policy.—March 5.

Iron Works, Pennsylvania, closing down of rolling mills at Naomi and Gibraltar and the Keystone rolling mill of Reading, in consequence of failure of Reading Iron Works.—March 6.

ITALY, New Cabinet, Crispi Signor, charged with formation of.—March 2.

Cabinet, Crispi Signor presents to King Humbert cabinet list composed of members of the left, but proposes King entrust Signor Branchieri with formation of transition Cabinet.—March 6.

Cabinet, constitution of.—March 7.

Chamber of Deputies, Crispi Prime Minister explains why he consents to remain in power.—March 18.

Chamber of Deputies, Signor Cavalotti calls Signor Corvetto, under secretary of War, a liar, challenge to duel, passes between them.—March 22.

Florence, sixty sudden deaths take place in an hospital, all preceded by intestinal disturbance.—March 23.

Rome, Deputy Cavalotti in a duel slightly wounds Signor Corvetto, under-secretary of war department.—March 23.

Rome, Father Agostino preaches at church of San Carlo, riot ensues, many arrests made.—March 27.

Rome, Bomb explodes in San Carlo Church, Rome, while Father Agostino preaching.—March 31.

Iridentist Agitation being revived throughout the provinces, meetings held in many places.—March 12.

Japan, Navy, 85,000,000 despatched to France as payment for last man-of-war ordered.—March 9.



- Jesuits, Toronto, Wilo Rev. Dr., takes up challenge of Whelan Rev. Father, to prove that oath of Jesuits sanctioned the doing of wrong that good may come of it.—March 3.
- Jesuits and *The Mail*, Toronto, action for \$50,000 for libel entered at Montreal.—March 5.
- Jesuits Estates Act, Toronto, great meeting at.—March 25.
- Jesuits Estates Act, Lord Kuntzford, British Secretary of State for colonies, presented with memorial from Protestant alliance on the subject.—March 26.
- Joachim, Jubilee of his *début* as a violinist observed at Berlin.—March 1.
- Kennedy Mr. H. E., editor and publisher of Morrisburg, Ont., *Courier*, death of.—March 20.
- Kerr bundle trial, New York, verdict of not guilty returned.—March 15.
- Kootenay, British Columbia, Smelting and Trading Company, registered in London, Eng.—March 7.
- Labor question, New York, dismissed at meeting of business men's Republican Club.—March 26.
- Lord, American, Mexican Government takes steps to prevent introduction of.—March 22.
- LEGAL**, Boston, death of Sidney Bartlett, the Nestor of the Suffolk Bar.—March 6.
- Divorce, London, Eng., Marquis of Donegal's case against, dismissed, counter-suit brought by the Marquis against Lady Donegal also dismissed.—March 21.
- Divorce, McCombe James C., millionaire, applies for, on ground of incompatibility of temper.—March 20.
- Justice Stanley Matthews dies at Washington.—March 22.
- London, Eng., *Irish World* by decision of Judges the Land League held responsible for policy of the paper.—March 5.
- Montreal, Jesuits v. *The Mail* Printing Company of Toronto, action entered for \$50,000 for libel.—March 5.
- New York, Arcade Railway, at the suit of J. J. Astor and others Court of Appeal decides that Arcade railroad law is unconstitutional.—March 12.
- New York, ex-president Cleveland, elected active member of bar association.—March 12.
- New York, Totten Clara sues C. H. Reid of Hoffman House for \$100,000 for breach of promise of marriage.—March 25.
- New York, divorce obtained by Mrs. Helen G. Bishop against Washington Irving Bishop, the mind-reader.—March 27.
- Ottawa, Mrs. Bell v. Sir Charles Tupper, case concluded, verdict for defendant.—March 15.
- Russia, Supreme Court at St. Petersburg decides that Princess Eohen-lohe, wife of the Statthalter, of Alsace-Lorraine, is indebted to Bank of Commerce in 6,000,000 roubles.—March 18.
- Scotland, Frazer Lord, Judge of Outer House Scotch Court of Session, death of.—March 28.
- Toronto, Watson J. A., charged with seducing Miss Alice Kirby, jury bring in verdict for \$5,000.—March 28.
- Toronto, Morton and Black and Central Bank, Master in ordinary holds that deposit receipts cannot be looked upon as negotiable securities.—March 9.
- Toronto, Chancery Divisional Court, action of John A. Macdonnell to unseat Hon. S. H. Blake as member of law Society dismissed.—March 5.
- LITERARY**—Sangster Mrs. Margaret E., accepts position of editor of *Harper's Bazaar*.—March 25.
- Lonsdale Lord, arrives at the Ramparts Arctic circle, last outpost of Hudson Bay Company.—March 16.
- Lord's Day Alliance meeting of, at Ottawa, election of officers.—March 22.
- Luxembourg, Council of State resolves to invite Duke of Nassau to become regent.—March 30.
- McCormick Rosanna, eccentric woman, dies at Jordan's White Sulphur Springs, Pa.—March 24.
- McKay Mr. Hugh, prominent citizen of Regina, sudden death of.—March 24.
- McMaster University, senate in session at Toronto.—March 7.
- Maldstone, Terre Haute, Ind., applied to daughter of John Kirk, of Bush County.—March 25.
- Mail* subsidies, Canadian Gazette publishes details regarding.—March 14.
- Maine House passes bill providing severe punishment to person selling his vote.—March 7.
- MANITOBA** legislature, real property act passed.—March 1.
- Legislature, Hudson Bay Railway, four and a half million guarantee act repealed, and act passed, granting cash bonus of \$2,000 per mile passed.—March 2.
- Legislature, prorogation of.—March 5.
- Manitoba Mortgage Company, annual meeting held at London, Eng.—March 24.
- MARRIAGES**—Germany, Princess Sophie of Prussia, formally betrothed by proxy in Berlin to son of King of Greece.—March 7.
- Breach of promise, New York, Totten Clara sues C. H. Reid of Hoffman House for \$100,000.—March 25.
- Count Condeshore to daughter of Count Von Taafé, Austrian Premier, betrothal of, announced.—March 22.
- Halifax, Bouchier Rev. Mr., Chaplain of Royal Navy, to Miss Katherine Thomson, grand-daughter of late Hon. Joseph Howe.—March 23.
- Keyser, W. Va., (Ohio Poland), aged 13, married to Joe Snow, aged 14.—March 13.
- Milwaukee, Pauline Fuller, fifth daughter of Chief Justice Fuller, to J. Matt Aubrey, jun., of Chicago.—March 20.
- New York, Langtry Mrs., reported to be married to Mr. Gebhard.—March 5.
- New York, Boucicault Mr. Dion to Miss Louise Thornlyke.—March 7.
- Portland, Duke of, engagement announced to Miss Dallas Yorke.—March 4.
- Mason J. W., of West Virginia, appointed commissioner of Internal Revenue at Washington.—March 18.
- Massachusetts Senate passes bill to regulate telephone charges in the state.—March 7.
- Massachusetts Legislature bill granting municipal franchise to women defeated.—March 12.
- Matthews Justice Stanley, death of, at Washington.—March 22.
- Mensles, London, Eng., serious epidemic of.—March 16.
- MEDICAL**—London, Eng., Gerhardt Prof., eminent physician of Berlin, entertained at dinner by Sir Andrew Clarke.—March 20.
- Seranton, Pa., needle taken from foot of Charles Nier, by suburban electric railway dynamo.—March 21.
- Germany, Dr. Schwoninger, Prince Bismarck's physician undergoes painful surgical operation.—March 22.
- Montreal, Howard Fr. B., D. D., Dean of Medical Faculty of McGill College, Montreal, death of.—March 28.
- Mexican International Improvement Company adjudge of a fraudulent concern.—March 15.
- Mexico, Cabinet dismisses Lower California, and decides to protect the frontier.—March 9.
- Mexico, two steamers sail from San Diego for Eusemada, loaded with miners and prospectors, Gov. Torres telegraphs the Mexican Secretary of war for additional troops.—March 14.
- Mexico Government takes steps to prevent introduction of American herd.—March 22.
- Mexico, Lake Chapala, State of Jalisco, excursion party of 17 persons drowned.—March 25.
- MILITARY**, Bavaria, quarrel between Princes and Generals, several of latter dismissed.—March 6.
- Algeria, Soldier named Perjoie sentenced to death in Oran for throwing quid of tobacco in face of Col. Thierry while being tried for desertion.—March 15.
- Bermuda, entire garrison officers and men of English Fort Cunningham, desert.—March 14, rep. 25.
- British, Honorable Artillery Company, Queen restores to the Company its ancient privileges.—March 16.
- Britain, Wolsey Gen. Lord, speaks on national defences at dinner given by Volunteer Medical staff at London, Eng.—March 1.
- British, Mr. Stanhope in explaining army estimates in House of Commons says, that owing to increased protection afforded the colonies, Government had provided for increase in colonial contributions.—March 11.
- Canada, general orders as to Long course certificates, and changes in Quebec regiments.—March 1.
- Canadian Parliament, committee of public accounts, Militia clothing contracts for, dismissed.—March 20.
- Court of Enquiry at Halifax report with reference to alleged attempt to blow up *duckynard* Magazine.—March 20.
- France, request accorded to, by Germany, for permission to transfer remains of Generals Carnot and Marceau to France.—March 23.
- Germany, Government orders manufactory for steel rifles to be erected at Spandau.—March 22.
- Germany, 80,000 swords of new pattern and large number of repeating rifles ordered by Government.—March 25.
- Germany, artillery, supplementary estimates for increase and re-organization of, discussed in Reichstag.—March 15.
- Germany, General Count Von Haebel, commander of sixth division of Third Army Corps, to succeed Count Von Valdezer as Quartermaster General of Imperial Army.—March 2.
- Hungary, Army bill considered, motion against second year's service for volunteers rejected.—March 26.
- Italy, Crisp Signor warns Prince Bismarck and Count Kalnoky, that development of Italian Army must undergo period of suspension.—March 6.

## MILITARY.—Continued.

- Montreal, Prince of Wales Rifles Association, annual meeting of.—March 12.
- Prussia, 70th Anniversary of entry of Count Von Moltke into army celebrated at Berlin.—March 8.
- Russia, Czar incensed against Col. Atehinoff, commander of Cossack expedition to East Africa, and orders his trial immediately on his arrival at Odessa.—March 4.
- Russia, officials report favorably upon invention for applying revolver of the present to barrels of the Borden rifles.—March 21.
- Russia, arrangements for army transportation in case of war completed.—March 26.
- United States, Youngstown, N.Y., General now among troops stationed at.—March 15.
- Mining, Dufferin gold mine, Halifax County, N.S., sold by auction for \$145,000.—March 14.
- Mining, gold, Santa Clara, Lower Cal., correspondent of San Francisco *Examiner* says they are a *glittering delusion*.—March 28.
- Mining, Santa Clara, Cal., armed Mexican hold quartz claim, Governor Torres asks for troops.—March 28.
- Mining, Pittston, Pa. region, notices posted at collieries notifying men of suspension of six weeks.—March 25.
- Minnesota State Senate, Bill confirming title of Duluth and Winnipeg Railway to land in North Minnesota defeated.—March 20.
- Missouri Legislature refuses to order engrossment of bill to prohibit Sunday base-ball players.—March 25.
- Moltke Count Von, 70th anniversary of entry into Prussian Army celebrated at Berlin.—March 8.
- Montenegro, Russian Imperial family subscribes cost of several thousand American repeating rifles and ammunition for Prince of Montenegro vide Vienna "Political Correspondence."—March 18.
- Moonshiners, Wyoming and McDowell countries, W. Va., Detective Baldwin says and posse surrounded, and their lives threatened.—March 18.
- Morocco and England, announcement made in British House of Commons that British squadron gone to Tangier.—March 19.
- Morocco, England demands indemnity for massacre and pillage at Fort MacKenzie factory, at Cape Jubay.—March 22.
- Morocco and England, Sultan of Morocco gives satisfactory assurances to all demands of English Government.—March 25.
- MURDERS.—Calgary, N.W.T., Squaw named Rosalie found murdered in room over Turf Club Saloon.—March 1.
- Bonn, Pfeiffer, youth named, killed by a soldier of the garrison; townspeople incensed at apathy of military in the matter.—March 30.
- Calgary, Squaw Rosalie, Coroner's Jury return verdict of wilful murder against William Fisk.—March 2.
- Augusta Centre, Norton Metcalf, his murderer, Virgil Jackson, hanged at Utica, N.Y.—March 14.
- Charleston, S.C., Dawson Capt. F. W., editor of the *News and Courier*, shot by T. B. McDow, a physician.—March 12.
- Chicago, millionaire Snellman, supposed to be Tascott the murderer, arrested at Nauvau, B.C.—March 15.
- France, Monte Carlo, M. Griscendorf, son of Swiss Consul at Cannes found murdered near railroad track.—March 26.
- Guelph, Ont., Harvey W. H., shoots his wife and two children, murderer arrested in Toronto.—March 26.
- London, Johnson, colored cook on schooner, shot by Theodore Noa.—March 27.
- Megantic, Morrison, expedition starts from Montreal to effect capture of the outlaw.—March 29.
- Mexico, Quarry, four Americans from El Paso kill two Mexican policemen.—March 28.
- Minneapolis, Tollefsen, car driver. Two men Tim and Pete Barrette hanged for the crime.—March 22.
- Montreal, Bridget Doyle, Benson on trial.—March 13.
- Ottawa, Kelly Mrs Catherine, verdict of Coroner's Jury.—March 1.
- San Francisco, Len Yum, ticket taker at Chinese theatre, killed on the street.—March 25.
- Watford, Ont., Marshall Miss Sarah, shot by Albert Wilson.—March 10.
- Winnipeg, Hatfield wife case, Jury returns verdict of manslaughter.—March 18.
- Yellowstone National Park, five French travellers murdered and horribly mutilated by Indians, news brought to Cheyenne by half-breed hunter.—March 10.
- Musical, Joachim, jubilee of his *debut* as a violinist observed at Berlin.—March 1.
- NAVAL.—British, Lord George Hamilton in House of Commons asks for twenty-one million pounds to be spent on new vessels.—March 7.
- American warships "Trenton," "Vandalia," and "Nipsic," wrecked at Samoa.—March 29.

## NAVAL.—Continued.

- British man-of-war "Sultan" wrecked off Island of Comino.—March 7.
- British, H. M. S. "Icarus" arrives at Victoria, B.C., and goes into dry dock having received injury from Lieberg in strait of Magdalen.—March 11.
- British, announcement in Commons that Australia has promised £35,000 annually for ten years towards building war ships, and to fully maintain war ships when completed.—March 12.
- British Channel squadron arrives at Tangiers to support England's claims regarding the cable and other matters.—March 16.
- British two ironclads sail from Gibraltar to join squadron at Tangiers.—March 20.
- British, Warship "Lilly" arrives at Halifax with case of yellow fever on board.—March 20.
- France, Admiral Jaurès, Minister of Marine, death of.—March 13.
- France, Admiral Krautz appointed Minister of Marine.—March 16.
- France, Torpedo boat founders off Cherbourg, Captain and fourteen of crew drowned.—March 22.
- German, warships "Olga," "Adler" and "Eider" wrecked at Samoa.—March 29.
- Japanese, \$5,000,000 dispatched to France as payment for last man-of-war ordered.—March 9.
- United States, Rear Admiral Davis retired, death of, at Washington.—March 12.
- United States, favorable report on gunboat "Yorktown" made by the board at Washington.—March 21.
- Nebraska Legislature, bill to tax sleeping and dining cars passes both houses.—March 21.
- Negro exodus, North Carolina, Emigration Society organized for forming colonization of negroes in Arkansas.—March 18.
- Negro problem, Richmond, Va., Secretary of commonwealth, Henry W. Flournoy, speaks upon, before Pughlinton Democratic Club.—March 11.
- New Brunswick Legislature, Franchise bill introduced by Government.—March 16.
- Newfoundland, banks of, deputation urges Premier Tizard and M. Spuller, French minister of Foreign affairs, to deal with neutralization of, during fishing season.—March 25.
- New Jersey Legislature, Australian ballot bill passed by.—March 27.
- New Jersey Assembly, Wertz local option repeater bill passed.—March 19.
- New South Wales, Ministry resigns after defeat on question of protection.—March 6.
- New York Assembly, resolutions congratulating Parnell on his vindication from the charges of London *Times*, adopted.—March 1.
- New York Assembly, bill allowing women to vote at municipal elections, defeated.—March 25.
- Nice beauty show, Mrs. Pierie of New York awarded first prize, which she returns to be devoted to charitable purposes.—March 21.
- Nihilism, Russia, circular issued by Nihilist committee as to apparent inactivity of Nihilist leaders.—March 9.
- Nihilists, Russian detectives sent to Switzerland to negotiate for extradition of.—March 27.
- Nova Scotia Legislature Franchise bill introduced by the Government.—March 15.
- Nova Scotia Legislature, House of Assembly rejects proposition to allow Dominion Government officials to vote at municipal elections in Nova Scotia.—March 21.
- Oklahoma Station, boomers at that point fired upon by regular troops, and further violence expected.—March 19.
- Oklahoma J. T., fear of conflict between troops and boomers bring General Weaver and Captain Couch to the scene.—March 21.
- Oklahoma Territory, great enthusiasm on issuance of proclamation opening new country.—March 28.
- Oleomargarine, New Haven, Ct., 11,000 pounds of, seized at factory of N. J. Nathan & Co.—March 25.
- Ontario Association of Architects organized at Toronto.—March 22.
- ONTARIO LEGISLATURE.—School books, dearness of, discussed.—March 6.
- Debate on the use of the French language in public schools.—March 8.
- Debate on Mr. Craig's motion on the teaching of French in the public schools of the province resumed, motion for return carried.—March 11.
- Toronto registership bill strongly opposed, the bill goes into committee.—March 12.
- Bill to amend anatomy act discussed.—March 13.
- Railway resolutions introduced by Provincial Treasurer.—March 15.
- License law, Mr. Meredith's resolution on the Government supported on a division.—March 15.
- Meredith Mr., challenges Government policy in three divisions.—March 18.

## ONTARIO LEGISLATURE.—Continued.

Language in schools, Mr. Craig's want of confidence, motion defeated.—March 19.

Text books in Schools, Mowat Premier, declares that the education department has no control over text books used in separate schools of Provinces.—March 19.

Halfway bill discussed.—March 20.

Insolvency bill of Mr. Bronson, M.P.P., passed.—March 21.

Closing of session.—March 21.

Oppia, Sultanate of, an Somali coast, Italy, assumes protectorate over.—March 15.

Opium smuggling trial closes at Bismarck, Dak.—March 14.

Orange Grand Lodge of Ontario west opens session at Hamilton, Ont.—March 13.

Paper makers, England, fourteen of the largest form syndicate to raise prices.—March 20.

PARNELL-TIMES.—Commissioner, Pigott commits suicide at Madrid.—March 1.

Commission, Mr. Labouchere gives evidence as to his dealings with Pigott.—March 1.

Commission, reading of articles in *Irish World* resumed, as to Mr. Davitt's actions.—March 5.

Commission, Coleman, ex-American Fenian gives evidence.—March 7.

Commission, Mr. Frederic Harrison writes protesting against retention of Sir R. E. Webster in the Cabinet.—March 9.

Commission, sitting resumed, evidence regarding the books of the Hilbermann Bank.—March 12.

Commission, Land League's books, evidence as to, Mr. Parnell's private account ordered to be investigated, Mr. Colffe, reporter from Cork, arrested by order of the Court.—March 12.

Mr. Parnell brings an action against the *Times* for £100,000, and Mr. Campbell his Secretary another for £5,000.—March 12.

Commission, Soames Mr., solicitor for *The Times*, gives testimony.—March 13.

Lord Hartington addresses a meeting at Islington, London, Eng.—March 13.

Harcourt Sir William Vernon, at meeting at Ely, reads letter from Pigott to Sir Hugo Childers, written in 1885, offering to sell secrets of the alliance between Parnellites and Tories.—March 14.

Parnell Mr. C. S., M.P., London, Eng., great demonstration in his honor in St. James' Hall, London, Eng.—March 13.

New York Assembly, resolutions congratulating Parnell adopted.—March 1.

Home Secretary questioned in House of Commons as to action of Anderson, an official of the Home office.—March 15.

Patents, Edison Electric Light Co. and United States and Westinghouse Companies, Commissioner of Patents at Ottawa decides against Edison Company.—March 7.

Panmoult Sir Julian, appointment of, as British Minister to United States semi-officially confirmed in London.—March 1.

PANAMA CANAL.—British vessel "El Dorado" passes through from Aspinwall to Chagres, distance of fifteen miles.—March 7.

The French Government refuses aid to debate in chamber of deputies.—March 7.

Company announces in Paris that further extension of provisional contract has been arranged with contractors.—March 18.

Penceock Richard, M.P., for Gordon Division of Lancashire, England death of.—March 2.

Persia, Russia demands the exclusive right to navigate rivers flowing into Caspian Sea and to build railways.—March 15.

Persia and Russia, Persian government engages to grant no railway concessions without consulting Russia.—March 20.

Peru, Vergmas bridge on the Grogga railway swept away by floods.—March 23.

Philippine Islands, 500 deaths from cholera at Zamboonza.—March 22.

Pilgrims, American, received at Rome by the Pope.—March 18.

Pilgrims American, Rome, grand dinner in their honor in the American College.—March 19.

Pilgrims, American, arrive at Naples.—March 25.

Pittsburg, Pa., uproar at the Academy of Music by anti-Germans.—March 9.

Plainfield, N.J., hotelkeepers decide to close up, owing to refusal of Common Council to grant licenses.—March 1.

POPE, THE, Celebrates 79th anniversary of his birth.—March 2.

Ireland, Pastoral letters read in the Catholic churches express sympathy with the Pope's position.—March 3.

Portland, Me., Board of Trade banquet, speech by Mr. Erastus Winou.—March 20.

Portugal, anti-slavery society formed in Lisbon with King Louis, as president.—March 22.

Postal, Philadelphia, Fle' ' is offer of Philadelphia postmaster'ship.—March 25.

Postal, United States, informs member of Congress partisanship would not be sufficient cause for removal of postmasters, *vide W. Star*.—March 23.

Prince Edward Island Legislature, opening of, speech from the throne.—March 14.

Prohibition, Wanamaker Postmaster General, interview thereon, at Philadelphia, Pa.—March 17.

Providence, R. I., Republican State convention re-nominates Royal G. Taft for Governor, but on his refusing nominates Herbert W. Ladd, of Providence.—March 21.

Prussian Government grants 5,000,000 marks to aid in reconstruction of canal connecting the Elbe and Trave rivers.—March 19.

Prussia, West, governor in view of scarcity of farm hands suggests introduction of Chinese labor.—March 13.

Prussia, Diet refuses to sanction proposed partition of Schleswig-Holstein.—March 25.

Prussia East, Vistula overflows its banks, and bridge at Lublen destroyed.—March 25.

QUEBEC LEGISLATURE.—Budget, want of confidence resolution defeated.—March 1.

House in Committee of supply.—March 2.

Council of public instruction, correspondence relating to resignation of members moved for, appointment of Forest rangers in Gaspé discussed.—March 4.

Public accounts committee, examination of Mr. W. E. Lockwood commenced.—March 4.

The Provincial boundaries, explanation from Hon. Mr. Mercier.—March 5.

Mr. Taillon denies charges in *L'Electeur* against the Ross-Taillon ministry, Lunatic Asylum's bill discussed.—March 7.

Premier's resolutions as to railway grants to Provincial roads, House in committee of supply, Desjardins's non-confidence motion defeated, Bill respecting the executive administration of the law passed.—March 8.

Want of confidence, motion of Mr. Beauchamp defeated, committee of supply vote on reappointment.—March 9.

Lockwood investigation resumed, Mr. Cook, advocate, examined.—March 9, 11.

Arbor day discussed, Montreal magistrates' salaries discussed, The B. A. bill the debate resumed.—March 11.

*L'Electeur* charges commission, resumption of.—March 11.

Mr. Lohlan's vote condemning the Government defeated, Budget considered, Mr. Taillon's vote of want of confidence defeated.—March 12.

Bills amending law respecting interments and disinterments and grants to railways read a third time.—March 12.

*L'Electeur* charges, Mr. Pacand of *L'Electeur* testifies.—March 12.

Lockwood case, Messrs. Rivard and Taché testify.—March 12.

Report of committee on Ross-Taillon, *L'Electeur* charges discussed, "Le Dictionnaire du Langage des nombres" discussed.—March 13.

Committee on *L'Electeur* charges, Mr. Whelan, contractor, gives evidence.—March 13.

The *L'Electeur* charges, Mr. Pacand's refusal to answer questions discussed, The B. A. bill passes the Assembly.—March 14.

*L'Electeur* charges, special committee meets, Mr. Whelan examined.—March 14.

*L'Electeur* charges, committee resumes, Mr. Whelan, Mr. Blanchet and Mr. Charlebois give evidence.—March 15.

Committee of supply, grant for colonization purposes discussed, Report of Ross-Taillon *L'Electeur*, special committee presented.—March 15.

Travelling expenses of members of the Government, want of confidence motion defeated.—March 16.

Agricultural schools discussed, agricultural schools report of Agricultural commission as to, discussed, ex-ministers make declaration as to *L'Electeur* charges.—March 18.

Ross-Taillon Commission on *L'Electeur* charges, bill to appoint, passes the Assembly.—March 19.

The Jesuits Grant question by Mr. Robertson, Government expenditures on land surveys discussed, *L'Electeur* charges, commission bill thrown out.—March 19.

License bill, Montreal, passed, the Lockwood case vote passed.—March 20.

The B. A. bill rejected.—March 21.

Prorogued.—March 21.

RAILWAYS.—Conference of State railroad commissioners and Interstate commerce commissioners at Washington, safety appliances on Freight cars discussed.—March 7.

Arcade Railway, New York city, Court of Appeals decides in suit of J. J. Astor and others that Arcade railroad law is unconstitutional.—March 12.

## RAILWAYS.—Continued.

Rockville and Westport, seizure of rolling stock made by Grand Trunk Railway.—March 14.

Canada Atlantic decides to extend its line from Glen Robertson to Hawkesbury on Ottawa river.—March 11.

Canadian Pacific bill passes Railway Committee of Canadian House of Commons.—March 22.

Canadian Pacific, Guelph branch, city of Guelph passes by law to raise \$18,000 amount for making branch remaining unpaid.—March 25.

Cape Breton line, contract for construction of bridge across Grand Narrows, awarded to Messrs. Simms & Slater, price \$525,000.—March 28.

Caracquet railway, meeting in London, Eng.—March 28.

Chicago, Burlington and Quincy Company, report for 1888 issued.—March 19.

Chicago division of Wabash railway sold to purchasing committee for \$3,500,000.—March 11.

Chicago, Milwaukee and St. Paul Road announces reduction of five cents per 100 pounds on wheat and flour from Minneapolis to Chicago.—March 8.

Chignecto Marine Company, prospectus issued in London.—March 18.

Chignecto Company, cable from London, Eng., says issue a complete success, shares being quoted at a premium.—March 21.

Colorado and Pacific Company, articles of incorporation filed at Denver.—March 23.

Cumberland Coal and Railway Company, R. G. Leckies resigns managing directorship.—March 13.

Duluth and Winnipeg Company, bill confirming land to, in North Minnesota defeated in Minnesota Senate.—March 20.

Freight Agents meet at Toronto and decide as to prices for the year.—March 23.

Grand Trunk cited by Interstate Commerce Commission at Washington for violating law by granting rebates.—March 26.

Grand Trunk issues notice as to grain rates to Montreal from Toronto and points east.—March 26.

Grand Trunk, Alfred, Ont., municipal council votes bonus of \$6,000 for new Vandriell and Prescott line.—March 9.

Hudson Bay, Manitoba legislature repeals 44 million guarantee act and passes act granting cash bonus of \$2,000 per mile.—March 2.

International and Great Northern, Jay Gould and Russell Sage resign from the directorate at meeting at Palestine, Tex.—Feb. 18, reported March 2.

Jay Gould interviewed at St. Louis on the situation.—March 13.

Kingston Street Car purchased by Folger Bros.—March 12.

Kingston, Smith's Falls and Ottawa Company, by-law granting \$20,000 passed in the township of Leeds and Lansdowne.—March 12.

Kingston, Smith's Falls and Ottawa Company, by-law granting subsidy passed in South Crosby Township.—March 2.

Manitoba and North Western notified by Attorney General of Manitoba of the intention of Government to repeal Act as to selling lands of the company.—March 4.

Measures pass the railway committee, Ottawa.—March 12.

Northern Pacific railroad bill passes committee at Ottawa.—March 15.

Northern Pacific and Manitoba, loan negotiated with New York syndicate for six millions in bonds of the road.—March 18.

Northern Pacific secures control of Wisconsin Central.—March 23.

New York and Northern Railroad and New York and New England Road, syndicate formed for combining the working of both.—March 7.

Ontario legislature, resolutions introduced by Provincial Treasurer.—March 15.

Ottawa and Morrisburg railway, bill incorporating, defeated in Senate Railway committee.—March 25.

Quebec and Lake St. John Railway reduces its freight tariff by 8 per cent.—March 16.

Rome, Watertown and Ogdensburg, action of collector of customs exacting fee on cars brought to Ogdensburg by ferry steamer, affirmed by U. S. Treasury department.—March 30.

Russin, Train on Transcaspian railway wrecked, owing to removal of rails by robbers.—March 9.

Ship railway from Georgian Bay to Toronto, scheme presented by Mr. Kivas at Toronto Board of Trade.—March 13.

Temiscouata railway, £50,000 investment mortgage debenture bonds offered on London market by Armstrong & Co.—March 9.

Temiscouata Railway, Town Council of Fraserville, P.Q., decide to pay bonus of \$25,000 to.—March 7.

Union Pacific men start from Butte Mont to hold Jefferson Canon, and Northern Pacific men start from Helena for same place.—March 5.

Valley railway of Canton, Ohio, sold to New York capitalists.—March 12.

Warned of recent amendments to Interstate Commerce Act.—March 8.

## RAILWAYS.—Continued.

West Virginia Central Road, Emmons Blaine elected vice-president with headquarters at Baltimore.—March 12.

Reading, Pa., Scott Foundry rolling mill, the new pipe mill and force of the facted iron works close down.—March 12.

Rhode Island Senate passes resolution re-submitting prohibitory amendment to the people.—March 13.

Rochereau M. Deufert, death of, at Paris, France.—March 5.

Rossa O'Donovan issues circular addressed to "Irish revolutionists," Rossa interviewed by *New York Journal*.—March 29.

Romania, Late President of chamber of Deputies receives letter threatening the destruction of chamber by dynamite.—March 8.

Rumania, Prince Ferdinand, King Charles' nephew, proclaimed Crown Prince of.—March 26.

RUSSIA, Czar incensed against Col. Atchinnoff, commander of Cosack expedition to East Africa, and orders his trial immediately on his arrival at Odessa.—March 4.

Atchinnoff expedition, Czar orders official inquiry into.—March 8.

Nihilism, St. Petersburg, circular issued by Nihilist committee as to apparent inactivity of their leaders.—March 9.

Transcaspian railway train wrecked, owing to removal of rails by robbers.—March 9.

Arrangements for army transportation in case of war completed.—March 26.

Narrow escape of Czar and Czarina while travelling from St. Petersburg to Gatchina, story published by *New Vienna Telegraph*.—March 27.

New four per cent. consolidated stock, applications for, so numerous that lists closed.—March 27.

Germany, Government issues White book on.—March 22.

Russia, military officials report favorably upon invention for applying revolver of the present to barrels of the Berdan rifles.—March 21.

St. John, N.B., decides to amalgamate with Portland, N.B., under the name of the "City of St. John."—March 19.

St. John, N.B., deputation from, interviews the Government at Ottawa, and asks that St. John be made the winter port of Canada.—March 13.

Salvation Army, Berlin, prohibited from carrying on its work.—March 9.

Salt trust, operators in Hutchinson, Kas., receive propositions from English salt trust.—March 20.

SAMOA and Germany, Stuebel, formerly consul general at Copenhagen, despatched to replace German consul Knappier recalled.—March 2.

Truce declared between German consul and Matafa until after Berlin conference.—March 4.

Humour current in Naval circles at Kiel that conflict has taken place between American man-of-war and German corvette "Olga."—March 4.

Steamship "Zealandia" arrives at San Francisco and reports things quiet, German consul made repeated overtures to Matafa looking towards conclusion of peace.—March 16.

Sir James Ferguson speaks upon, in British House of Commons, and states England has no right to interfere in the question.—March 7.

An American Warship said to have been blown up with all hands, by German Frigate "Olga."—March 8.

Robert Louis Stevenson, the novelist, writes from Hawaii, commenting vigorously upon the high handed action of Germans in Samoa.—March 9.

Humour of engagement between United States man-of-war "Nipsic" and German "Olga" denied.—March 14.

Tasmania, federal council in Hobart adopts address to the Queen as to conduct of Germany.—Feb. 7, reported March 16.

British residents warned to leave Saadna, German Admiral having announced his intention to bombard the place, despatches to German papers.—March 18.

Blue book on Samoa affairs issued in London, England.—March 20.

All quiet, Samoan *Times* resumes publication reported by Capt. C. N. Schoonmaker of U. S. Steamer "Vandalia" under date 23rd February.—Reported March 25.

German Government request John C. Klein, the journalist, be arrested at San Francisco and returned to Apia, to be tried for murderous assault.—March 29.

Terrific hurricane, American and German warships destroyed.—March 29.

Sungster Mrs. Margaret E., accepts position of editor of *Harper's Bazaar*.—March 25.

Scarlet fever, Delapere Township, Dak., Epidemic commencing great averages.—March 14.

Schleswig, Holstein, Prussian Diet refuses to sanction partition of.—March 25.

Schawaloff Count Peter, death of, at St. Petersburg.—March 22.

Sealing schooner "Wolf" arrives at St. John's, Newfoundland, with 28,000 seals.—March 20.

- Selkirk, Man., Governor Schultz offers one-fourth of his land as a grant in aid of an hospital.—March 7.
- SERBIA, King Milan abdicates the throne.—March 6.  
The regents grant permission to the young King to see his mother Ex-Queen Natalie.—March 7.  
Proclamation by regents as to their policy.—March 7.  
Service held in cathedral at Belgrade in honor of accession of King Alexander.—March 17.  
Ex-premier Garašanin announces he will publish true reasons for King Milan's abdication.—March 19.  
King Alexander requests his mother Ex-Queen Natalie to remain away from Serbia.—March 20.  
Belgrade, Pashies M., exiled revolutionist, returns to, and is welcomed by enthusiastic crowds.—March 22.  
Ex-King Milan returns to Belgrade.—March 23.
- SHIPPING, British barque "Port Gordon" from Liverpool for Puget Sound wrecked near Cape Flattery.—March 6.  
American bark "Agnes Barton" from Nassau to Baltimore driven ashore half a mile north of Dum Neck life saving station Virginia coast, six lives lost.—March 14.  
Antwerp, steamship "Indiana" run into by unknown schooner, staying hole in port how above water line.—March 23.  
Barque "E. L. Pettengill" of Portland, Maine, wrecked in Chesapeake Bay, supposed loss of crew of 13 men.—March 16.  
Bouth Bay, Me., British schooner "Gleaner" from St. John for New York seized for non-entry.—March 8.  
British steamer "Sultan" from New Orleans abandoned in sinking condition.—March 2.  
British ship "Vandulia" from Perth Amboy for London sunk by collision with unknown steamer off Bangor.—March 7.  
Canadian ship "Boek Terence" wrecked at Dum Neck, news brought to San Francisco by American missionary steam packet *Moving Star*.—March 23.  
Compagnie Générale Transatlantique of Paris decides to support movement to prevent Atlantic liners from traversing the Newfoundland cod fisheries.—March 15.  
German bark "Johanne Auguste" from Moodyville lost, crew arrive at Valparaiso.—March 20.  
German barque "Leonidas" lost on Goodwin Sands.—rep. March 11.  
Meier Mr., founder and manager of North German Lloyd Steamship Company, death of.—March 11.  
Norwegian bark "Ovear Odd" from Brunswick, Ga., for Buenos Ayres, abandoned at sea, crew arrive at St. Michaels.—March 20.  
New steamer "City of Paris" built by Thompson of Clyde Bank, for the Inman Company arrives at Liverpool.—March 22.  
New York, steamers "Alaska" and "Aurania" arrive after race across the ocean.—March 31.  
Ostend, steamer "Comtesse of Flanders" run into and sunk, 14 persons drowned.—March 30.  
The "St. Cloud" on voyage from New York to Java burned at sea, crew landed at Rio Janeiro.—reported March 19.  
Samoa, German barque "Peter Godfrey," one other barque and seven coasters wrecked.—March 20.  
Schooner "Adventure" from Seattle, W. T., arrives at Port Eyete, Alaska, after drifting for two months.—March 20.  
Santander, Norwegian barque "Ocean" burned, Captain Taraldsen and boy killed.—March 6.  
Spanish steamer "Rennis" with Spanish military expedition on board lost off Philippine Islands.—March 13.  
Spanish Mail steamer "Mindanao" sunk by collision with Spanish steamer "Visayas" which arrives at Manila.—March 20.  
Steamer "Ootlan" on Lake Chapala, near Guadalupe, Mexico founders with large number of excursionists on board.—March 26.  
Steamer "Colorado" picks up bodies of two sailors on raft, and later on passes large quantity of wreckage.—March 23.  
Steamboat "Kill von Kull" of New Jersey Central Railroad destroyed by fire at Elizabeth, N. J.—March 3.  
Toronto, schooner "Morning Star" first vessel in port.—March 24.
- Slavery—Anti, Portugal, society formed in Lisbon with King Louis as president.—March 22.  
Slave trade, resolution adopted by British House of Commons declaring Government should ascertain whether powers are willing to meet in conference to discuss the question.—March 26.  
Socialism in America, Chicago, lecture by Judge Grannell at the Kenwood Club.—March 16.  
Socialism, Germany, Berlin *Volk's Zeitung* suppressed by Government.—March 18.  
Shoa, King Menelek of, declares war against King John of Abyssinia.—March 9.  
Silver, West End Silver Mountain Mine, at Port Arthur, splendid streak found on drift working east.—March 5.  
Smallpox, Fingal and Southwold, Ont., 23 cases and 8 deaths.—March 7.  
Smallpox, Hamilton, N. Y., two cases of, discovered at.—March 7.
- Smallpox, London, Ont., Graham Mrs., taken ill with.—March 1.  
Smallpox, Southwold, two more deaths occur from.—March 14.  
Smuggling, Bismarck, Dak., Opium smuggling trial closes.—March 14.
- SPAIN—San Sebastian, Queen Victoria, meets Queen Regent Christina.—March 27.  
Spanish Senate, Cuba, Minister of Interior said Government had no knowledge of scheme to sell Cuba to United States.—March 20.  
Spies British, in America, resolution adopted by Irish National League urging action by congress of United States as to.—March 3.
- SPORTS, Aquatics, O'Connor Wm., of Toronto, defeats Gandour Jacob, of St. Louis, Mo., over three mile course of Alamada Creek.—March 3.  
Aquatics, American cup, Earl of Dunraven interviewed in London, Eng., as to his yacht and conditions of proposed contest.—March 28.  
Aquatics, University boat race, England, Cambridge won by four lengths.—March 30.  
Base ball, Chicago and all American base ball clubs sail from Quebec to New York.—March 28.  
Base ball, Missouri House refuses to order endorsement of bill to prohibit playing on Sunday.—March 25.  
Chess, New York, tournament, Weiss wins from D. G. Baird, Burn from J. W. Baird, Tschorn from Martinery, 3rd from Pollock, and Lelpschutz from Burrite.—March 29.  
Fishing, monster pike 4 feet long and 28 pounds weight captured at mouth of Perchouca river, Lake St. John.—March 25.  
Fishing, Parolise Club of Anglers of New York purchases 70,000 acres of Forest and 50 trout lakes in various parts of the country.—March 13.  
Football, Montreal Club, annual meeting of, held.—March 29.  
Kilrain Jake, sails from New York for England.—March 13.  
Lacrosse, Montreal, annual meetings of Beaver, Red Star and Dominion clubs held.—March 29.  
Racing, Lincoln Spring meeting, Lincolnshire handicap of 1000 sous won by Jardine's "Wise Man."—March 27.  
Racing, Lincoln, Spring meeting Balthany stakes won by Lord Dudley's "Poem."—March 25.  
Racing, Liverpool Spring meeting, Prince of Wales, plate won by Hammond's "Aintree."—March 28.  
Racing, Liverpool Spring meeting, Sefton Park plate won by Mr. Chitwick's "Barbette."—March 29.  
Racing, Liverpool, Grand National steeple chase, "Frigate" wins.—March 29.  
Racing, Derby Hunt meeting, Devonshire handicap hurdle race won by Tomes.—March 20.  
Skating, Halifax, N. S., Laidlaw defeats Dowd in ten mile race.—March 12.
- Springfield, Ill., colored people decide to erect monument to Abraham Lincoln and soldiers of late war.—March 14.
- STANLEY, H. M.—Private letters from Zanzibar report him to be marching towards east coast of Africa.—March 21.
- STRIKES, France, workmen at Armentieres on strike attack the factories.—March 7.  
Cabinetmakers and polishers, Nuremberg action regarded as signal for general strike among Trade's Union in South Germany.—March 30.  
Germany, the outbreak widespread, Berlin masons decide to inaugurate general strike in the building trades.—March 30.  
Miners, Salineville, Hocking Valley, strike ordered because operators insist upon using screens not regular in size.—March 15.  
Ostrich feather workers, the girls return to work at manufacturers' terms.—March 20.  
Painters and decorators, Berlin, meeting held at Hamburg, and strike determined upon.—March 15.  
Russia, crisis in relations between workmen and employers at St. Petersburg threatens to produce general strike.—March 4.  
Stonecutters, Cornwall canal works, for advance in wages.—March 9.  
Ship builders, Belfast, 1000 men idle, and strike spreading.—March 18.  
Weavers, Cornwall, (1st.), decide to return to work.—March 19.  
Weavers, Cornwall, settlement of.—March 20.  
Weavers, Fall River, Mass., the Executive Committee decides to reject proposition of state arbitrators.—March 15.  
Weavers, Fall River, Mass., weavers vote to continue strike, several more mills shut down.—March 21.  
Weavers, Cornwall, several employes of Stormont Cotton Co. accept terms offered, and return to work.—March 8.  
Weavers, Fall River, Mass., weaving departments of 50 mills shut down.—March 11.  
Weavers, Fall River, Mass., 3000 weavers assemble in the Park, agent at Pocasset Mill offers to compromise with strikers.—March 11.  
Weavers, Fall River, Mass., strike ends.—March 27.  
Weavers, Stormont Cotton Company close down their mill until the 1st May.—March 12.

Sugar, New York sugar trust raises prices of, all refined sugar cent a pound.—March 15.

Suicide, Antwerp, Ferdinand Vanderaetelen, merchant prince, kills himself.—March 28.

Suicide, Germany, Guebel Herr, shoots himself and a young Bavarian opera singer.—March 22.

Suicide, Hamilton, Ont., Cook William, caretaker of James Street Market, cuts his throat.—March 23.

Suicide, Lennoxville, P.Q., Gallagher Mrs. John, cuts her throat.—March 31.

Surveyors, Quebec, Provincial Land, yearly official table published.—March 4.

Sweden, Riksdag, second chamber of, rejects bill to improve duty on iron ore.—March 14.

Sweden, Diet, First Chamber, iron ore, bill for imposition of export duty upon, rejected.—March 16.

Switzerland, Bern, three more students arrested for complicity in the manufacture of bombs.—March 20.

Switzerland, Zurich, establishment for manufacture of bombs discovered. Two Russians arrested.—March 19.

Switzerland, Federal council recommends to Parliament the adoption of a credit for fertilizing St. Gothard.—March 28.

Sydenham, Ont., dynamite outrage at Methodist parsonage.—March 29.

Baltimore, Morris Miss Clara, cancels her engagement in consequence of sickness.—March 24.

Tammany Society, New York, Cleveland ex-president, elected a member.—March 20.

Telegraphs, Bermuda and Halifax, Postmaster announces in British House of Commons Government will lay cable.—March 21.

Theatrical, New York, Bonicaudt Mr. Dion married to Thorndyke Miss Louise.—March 7.

Anderson Miss Mary, by direction of her physician, cancels her Baltimore engagement.—March 13.

Langtry Mrs., suffering from acute tonsillitis, and cancels her engagement at New York for remainder of week.—March 14.

London, Eng., Love Miss Mabel, mysterious disappearance from the Gaiety Theatre.—March 20.

London, Eng., Hroughton Miss Phyllis, action for breach of promise against Viscount Dangan, compromised.—March 28.

London, Eng., Mabel Love, young Gaiety Theatre actress, found in Dublin.—March 22.

Maginnis D. J., actor, death of, at Boston.—March 18.

New York, Langtry Mrs., reported married to Mr. Gebhard.—March 5.

Paris, "Belle Manan" by Sardon and Des Landes produced at the Gymnase.—March 15.

Pittsburg, Pa., uproar at Academy of Music by anti-Germans.—March 9.

Tinplate, American consumers syndicate offers to purchase all tinplate works in South Wales.—March 15.

Tin ore, Pecos County, Tex., discovery of.—March 28.

Submarine Telegraph Co. accepts offer of British Government for purchase of that Company's cables.—March 26.

Toronto, schooner "Morning Star" first vessel in port.—March 24.

Tramps, Fairbury, Neb., publicly flogged for impudent and boisterous conduct.—March 25.

Treasury department, Washington, Tickener Geo. C., of Illinois, appointed assistant secretary.—March 9.

TRUSTS, Flour, St. Louis, Millers of winter wheat holding secret meetings for purpose of forming combine to control the output of flour.—March 7.

American Preservers Association of jellies and preserves comes to grief at Philadelphia.—March 15.

Binding twine, buys up most of the twine in Minneapolis.—March 14.

British Parliament, discussed in House of Commons.—March 15.

Lake Coal Dealers Association meet at Cleveland and complete a combination.—Feb. 28, rep. March 2.

Oranges, Florida, formation of, being pushed in New York.—March 21.

Paper makers, England, fourteen of the largest form syndicate to raise prices.—March 20.

Salt, operators in Hutchinson, Kas., receive propositions from English salt trust.—March 20.

Sugar, New York sugar trust raises prices of all refined sugar cent a pound.—March 15.

Tinplate American consumers syndicate offers to purchase all tinplate works in South Wales.—March 15.

Telephone, Frederickton and St. John, N.B., connection made between.—March 3.

Tupper Sir Charles, arrives at New York, and interviewed there.—March 1.

Tupper Sir Charles, High Commissioner, report of, issued at Ottawa.—March 9.

Turkey, Constantinople, meeting breaks out among portion of Cossacks attached to Atchinnoff's expedition.—March 17.

Ulbaech Louis, French novelist, death of.—March 16.

Underwriters, Canadian, convention of, at Montreal.—March 28.

UNITED STATES and Canada. The failure of excursion proposal, Mr. Erasmus Wiman interviewed thereon by *Mail and Express* of New York.—March 1.

Cabinet, President sends nominations to the Senate.—March 5.

Cabinet confirmed by the Senate.—March 5.

Cabinet, President signs commission of all the members, and they are formally inducted into office.—March 6.

Congress House, Commercial Union with Canada, motion carried as to appointing commissioners to assimilate import duties when Canada is ready.—March 1.

Presidential inauguration, General Harrison's inaugural address.—March 4.

Senate, Commercial Union with Canada, resolutions fail to pass.—March 4.

Senate, presidential nominations for diplomatic service.—March 11.

Senate, special committee on relations with Canada proposed and elected.—March 12.

Senate, Louis Riel, papers in the case of, presented and laid on the table.—March 12.

Senate, President sends nominations of Assistant Secretary of State, examiner of claims for the department of state, and assistant secretary of the interior.—March 13.

Senate, committee on interstate commerce meets at Washington, and makes arrangements for pursuing investigation of Canadian transportation matters.—March 19.

Senate, nominations by President of F. D. Grant, J. C. New and Seligman Bros.—March 20.

Senate, nominations of Calkins for commissioner of General land office, William M. Meredith of Illinois for public printer, and Murat Halstead, Minister of Germany, sent in by President.—March 22.

Senate refuses to confirm nomination of Murat Halstead as Minister to Germany, but confirms Loring to Portugal, Lincoln to Great Britain, Thornbyke to Russia, Hynn to Mexico, and Egan to Chili.—March 30.

Direct tax bill, vetoed by President Cleveland.—March 2.

Virginia West, decision of Supreme Court as to Governorship.—March 12.

Virginia West, Governorship, Supreme Court at Charleston decides that old Governor shall hold office till legislature meets.—March 16.

Wales, Penbryn Cardiganshire, attack by mob on policemen and other agency men serving title distrains, many men injured.—March 20.

Wanamaker, Postmaster General, on prohibition, interview at Philadelphia, Pa.—March 17.

Washington University, Bishop Keane presents Miss Caldwell to the Pope.—March 16.

Washington University, Pope issues brief, approving statutes of.—March 13.

Washington, riot by Pennsylvania troops in.—March 5.

Weavers, strikes among, in Massachusetts, weaving departments of 50 miles shut down.—March 11.

Weavers, Cornwall, Ont., strikers decide to return to work.—March 19.

Weavers' Executive committee, Fall River, Mass., decides to reject proposition of state arbitrators.—March 15.

Weavers, Fall River, Mass., vote to continue strike, several more mills shut down.—March 21.

Weavers, Fall River, Mass. Strike ends.—March 27.

Weavers, strike of, Cornwall, settlement of.—March 20.

Westphalia, Diet of, sends petition to Home Secretary to permit flogging of retractory inmates of workhouses.—March 22.

Wheat and flour, Milwaukee and St. Paul railroad announces reduction of five cents per 100 pounds from Minneapolis to Chicago.—March 8.

Wheat, Chicago, aggregate of transactions in very heavy sales of, may run away up into tens of millions of bushels.—March 12.

White Caps, Georgetown, Ontario, Mr. Crowe, an alleged wife-beater, flogged by the gang.—March 7.

Williamson Isaiah V., millionaire philanthropist, death of, at Philadelphia, Pa.—March 7.

Wiman Mr. Erasmus, interviewed as to failure by Congress to vote the sum necessary to entertain the members of the Canadian Dominion and Provincial Legislature, in New York *Mail and Express*.—March 1.

Wolsley General Lord, speaks on British National defences at dinner given by volunteer medical staff at London, Eng.—March 1.

WRECKS.—Bangor, British ship "Vandalia" from Perth Amboy for London sunk by collision with unknown steamer.—March 7.

British steamer "Solton" from New Orleans abandoned in sinking condition.—March 2.

## WRECKS.—Continued.

- Canadian ship "Rock Terra," news brought to San Francisco by missionary steam packet "Morning Star."—March 23.
- Cape Charles, bodies of two sailors picked up from life raft by steamer "Colorado," and later on passes large quantity of wreckage.—March 23.
- Cape Flattery, British barque "Port Gordon" from Liverpool for Puget Sound.—March 6.
- Chebourg, French torpedo boat founders, captain and fourteen of crew drowned.—March 22.
- Cheapeake Bay, Barque "E. L. Pettengill" of Portland, Me., supposed loss of 13 lives.—March 16.
- German bark "Johanne Auguste" from Moodyville lost crew, arrive at Valparaiso.—March 20.
- Goodwin Sands, German barque "Leonidas."—reported March 11.
- Island of Comino, British man-of-war "Sultan."—March 7.
- Norwegian bark "Orvar Odin" from Brunswick, Ga., for Buenos Ayres, abandoned at sea, crew arrive at St. Michaels.—March 20.
- Ostend, steamer "Countess of Flanders" run into and sunk, 14 persons drowned.—March 30.
- Philippine Islands, steamer "Premis" with Spanish military expedition on board lost.—March 13.
- Philippine Islands, Spanish steamer "Reims" on Jan. 30. China advices to San Francisco bring particulars.—March 19.
- Samon, United States and American warships wrecked in a hurricane.—March 29.
- Samon, German Bark "Peter Godefroy," one other bark and seven coasters.—March 29.
- Spanish mail steamer "Madianoa" sunk by collision with Spanish steamer "Visayas" which arrives at Manila.—March 20.
- Virginia coast, American bark "Agnes Barton" from Nassau to Baltimore driven ashore half a mile north of Dam Neck Life-saving station, six lives lost.—March 14.
- Windsor, Ont., Perry James, plasterer, going to Detroit with tools sent back by customs officer.—March 13.
- Yellow fever, Halifax, British Warship "Lily" arrives at, with case on board.—March 20.
- Yellow fever, Rio Janeiro, abatement of epidemic.—March 22.
- Wiman Mr. Ernest, speech of, on Commercial Union at Board of Trade banquet, Portland, Me.—March 30.
- Wissman Capt. and Peters Dr., arrive at Zaazibar.—March 31.

## THE SPECIAL FEATURES OF THE YOUTH'S COMPANION

For the year, include SIX SERIAL STORIES, and ONE HUNDRED and FIFTY SHORT STORIES, fully illustrated.

ALSO TALES OF ADVENTURES,  
ILLUSTRATED SKETCHES OF TRAVEL,  
HUMOROUS ARTICLES,  
SCIENTIFIC AND HISTORICAL ARTICLES,  
HOUSEHOLD ARTICLES,

One Thousand Anecdotes, timely Editorials on the leading questions of the day, and a whole page each week for the little ones.

### THE COMPANION

has won a place in the home life obtained by no other paper, and is read every week to nearly Half a Million families. With its Double Holiday Numbers at Thanksgiving, Christmas, New Year's and Easter, its Weekly Illustrated Supplements, its fine paper and beautiful pictures, no other weekly literary paper can approach it in value. It is really a \$2.50 paper for only \$1.75 a year.

Every subscriber receives the Supplements and Double Holiday Numbers, and the Annual Premium List with 500 Illustrations. Address,

THE YOUTH'S COMPANION,  
BOSTON, MASS.

## Photo-Engraving.

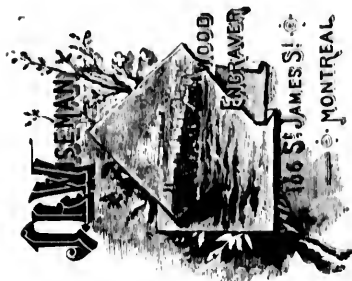

## Pen Drawing & Map Etching.



WHEN

YOU \* ARE \* READY

To order any more

**BINDING**

**PLEASE CALL UP**

**TELEPHONE \* 230**

Or send a POSTAL CARD to

**JOHN LOVELL & SON,**

23 & 25 St. Nicholas St., Montreal

Best work at ma-



## APPOINTMENT WANTED.

**POSITION WANTED** as correspondent for any papers or journals of whatsoever character. Am well acquainted with the work.

H. S. PICKETT, 11 Scott, Buffalo, N.Y.

FLUCTUATIONS OF THE STOCK MARKET.

MARCH 1 to 30.

	Friday 1	Saturday 2	Sunday 3	Monday 4	Tuesday 5	Wednesday 6	Thursday 7	Friday 8	Saturday 9	Monday 10	Tuesday 11	Wednesday 12	Thursday 13	Friday 14	Saturday 15	Monday 16	Tuesday 17	Wednesday 18	Thursday 19	Friday 20	Saturday 21	Monday 22	Tuesday 23	Wednesday 24	Thursday 25	Friday 26	Saturday 27	Monday 28	Tuesday 29	Wednesday 30			
Money on call, New York.....	2	2	2 1/2	2 1/2	2 1/2	2 1/2	2 1/2	2 1/2	2 1/2	2 1/2	2 1/2	2 1/2	2 1/2	2 1/2	2 1/2	2 1/2	2 1/2	2 1/2	2 1/2	2 1/2	2 1/2	2 1/2	2 1/2	2 1/2	2 1/2	2 1/2	2 1/2	2 1/2	2 1/2	2 1/2	2 1/2	2 1/2	
Sterling Exchange, New York.....	487	487	487	487	487	487	487	487	487	487	487	487	487	487	487	487	487	487	487	487	487	487	487	487	487	487	487	487	487	487	487	487	
<b>NEW YORK STOCKS CLOSING QUOTATIONS.</b>																																	
Canadian Pacific.....	52	51 1/2	50	50	50	50	50	50	50	50	50	50	50	50	50	50	50	50	50	50	50	50	50	50	50	50	50	50	50	50	50	50	
New York Central.....	106 1/2	103 1/2	104	104	104	104	104	104	104	104	104	104	104	104	104	104	104	104	104	104	104	104	104	104	104	104	104	104	104	104	104	104	104
Central Pacific.....	33 1/2	33 1/2	33 1/2	33 1/2	33 1/2	33 1/2	33 1/2	33 1/2	33 1/2	33 1/2	33 1/2	33 1/2	33 1/2	33 1/2	33 1/2	33 1/2	33 1/2	33 1/2	33 1/2	33 1/2	33 1/2	33 1/2	33 1/2	33 1/2	33 1/2	33 1/2	33 1/2	33 1/2	33 1/2	33 1/2	33 1/2	33 1/2	
Erie.....	29 1/2	30	29 1/2	29 1/2	29 1/2	29 1/2	29 1/2	29 1/2	29 1/2	29 1/2	29 1/2	29 1/2	29 1/2	29 1/2	29 1/2	29 1/2	29 1/2	29 1/2	29 1/2	29 1/2	29 1/2	29 1/2	29 1/2	29 1/2	29 1/2	29 1/2	29 1/2	29 1/2	29 1/2	29 1/2	29 1/2	29 1/2	
Louisville & Nash.....	60 1/2	61 1/2	61 1/2	61 1/2	61 1/2	61 1/2	61 1/2	61 1/2	61 1/2	61 1/2	61 1/2	61 1/2	61 1/2	61 1/2	61 1/2	61 1/2	61 1/2	61 1/2	61 1/2	61 1/2	61 1/2	61 1/2	61 1/2	61 1/2	61 1/2	61 1/2	61 1/2	61 1/2	61 1/2	61 1/2	61 1/2	61 1/2	
Lake Shore.....	104 1/2	104 1/2	103 1/2	103 1/2	103 1/2	103 1/2	103 1/2	103 1/2	103 1/2	103 1/2	103 1/2	103 1/2	103 1/2	103 1/2	103 1/2	103 1/2	103 1/2	103 1/2	103 1/2	103 1/2	103 1/2	103 1/2	103 1/2	103 1/2	103 1/2	103 1/2	103 1/2	103 1/2	103 1/2	103 1/2	103 1/2	103 1/2	
Northern Pacific Preferred.....	63	62 1/2	62 1/2	62 1/2	62 1/2	62 1/2	62 1/2	62 1/2	62 1/2	62 1/2	62 1/2	62 1/2	62 1/2	62 1/2	62 1/2	62 1/2	62 1/2	62 1/2	62 1/2	62 1/2	62 1/2	62 1/2	62 1/2	62 1/2	62 1/2	62 1/2	62 1/2	62 1/2	62 1/2	62 1/2	62 1/2	62 1/2	
Northwest Preferred.....	144	144	140	140	140	140	140	140	140	140	140	140	140	140	140	140	140	140	140	140	140	140	140	140	140	140	140	140	140	140	140	140	140
Reading.....	47 1/2	47 1/2	47 1/2	47 1/2	47 1/2	47 1/2	47 1/2	47 1/2	47 1/2	47 1/2	47 1/2	47 1/2	47 1/2	47 1/2	47 1/2	47 1/2	47 1/2	47 1/2	47 1/2	47 1/2	47 1/2	47 1/2	47 1/2	47 1/2	47 1/2	47 1/2	47 1/2	47 1/2	47 1/2	47 1/2	47 1/2	47 1/2	47 1/2
St. Paul.....	62 1/2	62 1/2	62 1/2	62 1/2	62 1/2	62 1/2	62 1/2	62 1/2	62 1/2	62 1/2	62 1/2	62 1/2	62 1/2	62 1/2	62 1/2	62 1/2	62 1/2	62 1/2	62 1/2	62 1/2	62 1/2	62 1/2	62 1/2	62 1/2	62 1/2	62 1/2	62 1/2	62 1/2	62 1/2	62 1/2	62 1/2	62 1/2	62 1/2
Union Pacific.....	66 1/2	67	66 1/2	66 1/2	66 1/2	66 1/2	66 1/2	66 1/2	66 1/2	66 1/2	66 1/2	66 1/2	66 1/2	66 1/2	66 1/2	66 1/2	66 1/2	66 1/2	66 1/2	66 1/2	66 1/2	66 1/2	66 1/2	66 1/2	66 1/2	66 1/2	66 1/2	66 1/2	66 1/2	66 1/2	66 1/2	66 1/2	66 1/2
<b>MONTREAL STOCKS SELLING PRICES.</b>																																	
Bank of Montreal.....	231 1/2	231 1/2	230	230	230	230	230	230	230	230	230	230	230	230	230	230	230	230	230	230	230	230	230	230	230	230	230	230	230	230	230	230	230
McGowan's Bank.....	139	139	139	138	138	138	138	138	138	138	138	138	138	138	138	138	138	138	138	138	138	138	138	138	138	138	138	138	138	138	138	138	138
Bank of Commerce.....	120 1/2	120 1/2	121 1/2	120 1/2	120 1/2	120 1/2	120 1/2	120 1/2	120 1/2	120 1/2	120 1/2	120 1/2	120 1/2	120 1/2	120 1/2	120 1/2	120 1/2	120 1/2	120 1/2	120 1/2	120 1/2	120 1/2	120 1/2	120 1/2	120 1/2	120 1/2	120 1/2	120 1/2	120 1/2	120 1/2	120 1/2	120 1/2	120 1/2
Montreal Telegraph.....	95 1/2	95 1/2	95 1/2	95 1/2	95 1/2	95 1/2	95 1/2	95 1/2	95 1/2	95 1/2	95 1/2	95 1/2	95 1/2	95 1/2	95 1/2	95 1/2	95 1/2	95 1/2	95 1/2	95 1/2	95 1/2	95 1/2	95 1/2	95 1/2	95 1/2	95 1/2	95 1/2	95 1/2	95 1/2	95 1/2	95 1/2	95 1/2	95 1/2
Montreal Gas.....	205 1/2	205 1/2	205	205	205	205	205	205	205	205	205	205	205	205	205	205	205	205	205	205	205	205	205	205	205	205	205	205	205	205	205	205	205
Northwest Land.....	70 1/2	71	72 1/2	72 1/2	72 1/2	72 1/2	72 1/2	72 1/2	72 1/2	72 1/2	72 1/2	72 1/2	72 1/2	72 1/2	72 1/2	72 1/2	72 1/2	72 1/2	72 1/2	72 1/2	72 1/2	72 1/2	72 1/2	72 1/2	72 1/2	72 1/2	72 1/2	72 1/2	72 1/2	72 1/2	72 1/2	72 1/2	72 1/2
Richelieu & Ontario.....	55 1/2	55 1/2	55 1/2	55 1/2	55 1/2	55 1/2	55 1/2	55 1/2	55 1/2	55 1/2	55 1/2	55 1/2	55 1/2	55 1/2	55 1/2	55 1/2	55 1/2	55 1/2	55 1/2	55 1/2	55 1/2	55 1/2	55 1/2	55 1/2	55 1/2	55 1/2	55 1/2	55 1/2	55 1/2	55 1/2	55 1/2	55 1/2	55 1/2
Street Railway.....	200	200	200 1/2	201	201 1/2	201 1/2	201 1/2	201 1/2	201 1/2	201 1/2	201 1/2	201 1/2	201 1/2	201 1/2	201 1/2	201 1/2	201 1/2	201 1/2	201 1/2	201 1/2	201 1/2	201 1/2	201 1/2	201 1/2	201 1/2	201 1/2	201 1/2	201 1/2	201 1/2	201 1/2	201 1/2	201 1/2	201 1/2
Canadian Pacific.....	514	514 1/2	514 1/2	514 1/2	514 1/2	514 1/2	514 1/2	514 1/2	514 1/2	514 1/2	514 1/2	514 1/2	514 1/2	514 1/2	514 1/2	514 1/2	514 1/2	514 1/2	514 1/2	514 1/2	514 1/2	514 1/2	514 1/2	514 1/2	514 1/2	514 1/2	514 1/2	514 1/2	514 1/2	514 1/2	514 1/2	514 1/2	

... for any paper well acquainted with the market, Buffalo, N.Y.

... Montreal

...hing

...Z

...P

...CER

...W.

...TED.



WHO SUBSCRIBE TO THE

## "INDEX OF CURRENT EVENTS."

The "Index of Current Events" is much appreciated not only by the press of Canada and the United States, but also by the public men of both countries. Its list of subscribers includes such great newspapers as the *Philadelphia Ledger*, the *Boston Transcript*, the *New York World*, the *Cincinnati Enquirer*, the *Brooklyn Eagle*, the *Toronto Empire*, the *Cleveland Leader*, the *Chicago Herald*, the *Cincinnati Post*, the *New York Morning Journal*, the *Chicago Daily News*, the *Indianapolis Journal*, the *New York Star*, the *Troy Budget*, the *Chicago Staats Zeitung*, the *New York Nation*, the *Troy Press*, the *Washington Star*, the *Chicago Inter-Ocean*, and many less known but important newspapers. Some of these papers are well known to keep admirable indexes of their own, yet find it advantageous to subscribe to the INDEX OF CURRENT EVENTS. We have the honor to include among our subscribers, Her Majesty's Privy Council for Canada; also, Sir John Macdonald, G. C. B., Premier of the Dominion, Sir Hector Langevin, Minister of Public Works, Sir A. P. Caron, Minister of Militia, the Hon. G. E. Foster, Minister of Finance, the Hon. Mackenzie Bowell, Minister of Customs, the Hon. J. A. Chapleau, Secretary of State, the Hon. John Costigan, Minister of Inland Revenue, the Hon. John Haggart, Postmaster General, the Hon. John Curling, Minister of Agriculture, the Hon. C. H. Tupper, Minister of Marine and Fisheries, the Hon. Commissioner of Agriculture and Colonization Quebec, the Hon. Boucher de La Bruère, late speaker of the Legislative Council, Quebec, the Hon. Lieutenant Governor Royal, Mr. Ernestus Winman, the Hon. Minister of Public Works, Toronto. The Librarian of Parliament, the House of Commons Reading Room and the Librarians of many of the Provinces of the Dominion and States of the Union subscribe to the *Index*. The leading bankers (including the Bank of Montreal), brokers, lawyers and hotel keepers of Canada, and many clergymen also keep the *Index* on file.

What is thought of the *Index* may be gathered from the numerous entirely unsolicited expressions of approval sent in by well known public men, of which the following are specimens:

MR. MARTIN J. GRIFFIN, LIBRARIAN OF PARLIAMENT, Ottawa, writes: I am sending you a subscription for two copies of your "*Index*," which will be most useful and which deserves encouragement. If you will take particular pains to give the dates and figures of elections and the dates of speeches of public men, with reference also to the place at which the speech was delivered, you will do a very grateful thing for public people and editors, and I may add librarians.

MR. JOHN M. DOANE, STATE LIBRARIAN OF Ohio, writes:—Enclosed please find \$3 dollars, in payment for State Library subscription to the "*Index of Current Events*" for 1889.

I regard it as a very valuable publication, and hope that you may meet with such success as to warrant its continuance, for it will grow more valuable every year.

MR. HERRIES, OF THE *BROOKLYN Eagle*, writes:—"I congratulate you most heartily upon having done a good thing, a very good thing, in starting the "*Index*" enterprise. I hope I may have the joy of congratulating you upon your success year hence. A man with *Index* on the brain is one after my own heart. My judgment was formed upon Number 1; if the indexing is kept up as thoroughly in all subsequent numbers it will be a great help to us."

SIR CHARLES TUPPER, BART., HIGH COMMISSIONER FOR CANADA, writes:—"It seems to me to be a very useful publication, and one that will be valuable for reference purposes."

MR. BURK, ASSOCIATE EDITOR OF THE *PHILADELPHIA Public Ledger*, writes:—"Your *Index* is highly appreciated at this office, where it has long been a desideratum."

MR. COLQUHOUN OF THE "*TORONTO EMPIRE*," writes:—"Allow me to congratulate you most cordially upon your admirable *Index*. The idea and its execution are alike worthy of all praise."

MR. VADEN, OF THE "*NEW-YORK MORNING JOURNAL*," writes:—"I find the *Indices* of great value, saving, as they do, much valuable time in looking up important events."

MR. WILL A. WOODWARD, REC. SEC. MASS. PRESS ASSOCIATION, writes:—"Enclosed please find subscription for one year for "*Index of Current Events*." I have examined the specimen sent me with much interest and do not hesitate to commend it as an invaluable assistant in the newspaper office. The amount of time and labor it is calculated to save, cannot be compensated by one hundred times its subscription rate,

Commencing with Vol. II No. I the dates given in the *Index* are the actual dates of the occurrences; not as formerly the dates of publication.

The *Index* is published four times a month; but to form a complete file for the year it is necessary to preserve only the first issue in each month.

The intermediate issues contain the news of the current month to date.

We have to acknowledge with thanks the receipt of a large number of papers offered in exchange for the *Index*. As the *Index* is published principally for the use of editors, and has to depend chiefly upon its contemporaries for support, it is obviously impossible for it to indulge in the luxury of an exchange list.

The subscription is \$6 per annum, payable yearly or half yearly in advance. Remittances should be made to

HENRY DALBY,

P. O. Box 864,

MONTREAL, Que.

The table showing the fluctuations of the stock market will be found on page 15.

# INDEX OF CURRENT EVENTS.

VOL. II. No. 16.

MONTREAL, MAY 4, 1889.

\$6.00 PER ANNUM.  
PUBLISHED WEEKLY.

## APRIL

Abyssinia, King John, reported death of.—April 3.  
Abyssinia, King John, death of, confirmed.—April 4.  
Abyssinia, Italian Prime Minister, in House of Commons, states effect of King John's death on Italy's position.—April 5.  
ACCIDENTS.—Drowning, Victoria, B.C., thirteen Indians drowned by capsizing of small schooner.—April 1.  
Drowning, Alabama, Midland, five laborers drowned by upsetting of boat on Chattahoochee river, Ga.—April 17.  
Drowning, Kingsfisher, Kas., settler named Gordon caught in quicksand and drowned.—April 12.  
Drowning, Midland, Jeffrey H. E., Little Robert, Meredith, and Anderson J. P., drowned while going from Midland to Victoria Harbor, Ont.—April 30.  
Drowning, St. Ann's, P.Q., Joe Sagala, well known fisherman and hunter.—April 30.  
Drowning, St. Paul de Chester, four men, Gagné, Roberge, Boisvert and Hincé, drowned in River Nicole.—April 18.  
Electricity, two men, Riley and Brown, killed while taking down telegraph wires.—April 18.  
Explosions, Anthracite Coal Mine, 12 miners injured.—April 7.  
Explosions, Durham, Brancepeth colliery, five persons killed.—April 24.  
Explosions, France, Calais, boiler of dredge bursts, killing seven persons and injuring seven others.—April 29.  
Explosions, New South Wales, Erin pit at Castrop, 25 persons killed.—April 10.  
Explosions, Thielblan Rothschild's colliery, 5 persons killed.—April 17.  
Fires, Aahland, Wis., Aurora mine in Gogebic range.—April 30.  
Fires, Auckland, New Zealand, U.S. Mail steamer "Mariposa," fire in hold.—April 24.  
Fires, Biarritz, British Club House destroyed.—April 15.  
Fires, Boston, freight houses of Boston and Lowell division of Boston and Maine Ry. destroyed.—April 9.  
Fires, Brooklyn, Buchanan and Lyall's tobacco factory.—April 12.  
Fires, Forest, North Adams and South Hadley, Mass., large quantities valuable timber destroyed.—April 22.  
Fires, Ind'a-Surat, hundreds of houses destroyed.—April 7.  
Fires, India-Surat, 15,000 persons rendered homeless, despatches received in London, Eng.—April 9.  
Fires, Leola, McPherson County, Dakota, destroyed by Prairie fire.—April 2.  
Fires, Lingwick, Que., house of Ludger Visana destroyed, Mrs. Visana burned to death.—April 14.  
Fires, Melbourne, Bijou Theatre burned.—April 22.  
Fires, Milwaukee, Margaret Klein and three children burned to death.—April 2.  
Fires, Mount Pleasant Village, Dak., nearly destroyed.—April 2.  
Fires, Nanticoke, Ont., Charles Moore fatally burned.—April 14.  
Fires, New York, New York Central Railway stores, Fairbank's refinery Vanderbilt elevators destroyed, damage three million.—April 19.  
Fires, Ottawa, Dubé's Hotel on Chelsea road, destroyed.—April 18.  
Fires, Patrick County, Va., fifty farmers burned out by forest fires.—April 17.  
Fires, Prairie, Dakota, great damage and heavy losses.—April 8.  
Fires, Prairie, Sully Co., letter received by Mayor of Chicago, stalling 25 residences, 48 barns, 600 sheep, and many horses and cattle destroyed.—April 8.  
Fires, Quebec, two storey factory of Joseph Laliberté destroyed.—April 17.  
Fires, Stanbridge, P.Q., business portion of town destroyed.—April 25.  
Lightning, Kentville, N.S., John Schofield and Son, killed during thunderstorm, and house wrecked.—April 21.

## ACCIDENTS.—Continued.

Railway, Brooklyn, Beecher Rev. Dr. Edward, run over by railroad car.—April 3.  
Railway, Decatur, Louisville and Nashville railroad, three men killed and several wounded in collision.—April 4.  
Railway, Green River, The Canadian Pacific Railway express runs into freight train.—April 24.  
Railway, Hamilton, Ont., St. Louis express jumps the track, many persons killed and injured, several cars burned.—April 27.  
Railway, Hochelaga, P. Q., Joseph Wright, employee of Canadian Pacific Railway, run over by locomotive.—April 8.  
Railway, Jersey City, N.J., Hoboken car No. 145 struck by engine at Grove street crossing, four men severely injured.—April 9.  
Railway, Joliet, collision between passenger and freight trains on Chicago, Santa Fe and California Railroad, three persons killed.—April 10.  
Railway, Lorenzo, Ill., Hughes and Converse, conductor and engineer of freight train, arrested.—April 19.  
Railway, Toronto, Robert Fleming, of Brampton, lawyer, killed at Strachan avenue crossing.—April 13.  
Railway, West Point, Va., Freight train on York River branch of Richmond and Danville Railroad, wrecked, four men killed.—April 8.  
Railway, Winnipeg, Man., Frank Peters crushed to death on Canadian Pacific Ry.—April 8.  
Shipping, Otter Island, steamer "Everett" sunk and five persons drowned.—April 18.  
Storm, Atlanta, Ga., wall falls down killing firemen Leach and Howell and several others.—April 24.  
Storm, Crescent Bay, Thompson Mrs., killed by large tree falling on her, Thompson Mr. knocked senseless.—April 4.  
Suffocation, Port Huron, Mich., James Olemus and Stephen Porter suffocated in vat of Mineral Bath Co.—April 9.  
Sunderland, Eng., platform gives way during laying of cornice stone of Reformatory by Marquis of Hartington.—April 17.  
Afghanistan, Gen. Resenbach, governor of Turkestan, reports tranquility to prevail along frontier.—April 8.  
Affleck Mrs., widow of Capt. John Affleck, death of, at Halifax, N.S.—April 11.  
AFRICA.—Nyanza and Usagara, Missionaries there safe, news received by English Church Missionary Society.—April 1.  
Congo State Government receives report on the exploration of river Zomain, an affluent of the Congo.—April 5.  
Congo, four hundred troops sent to Arawheim, letters received at Brussels.—April 27.  
West, British expedition destroys chief town of Wendeb tribe on Sulymale river and releases 3,000 slaves, despatches received.—April 24.  
Zanzibar, Rev. Messrs. Taylor, Edwards and Hooper, captured Chief Bushire, released on payment of ransom.—April 27.  
Zanzibar, German imperial commissioner assumes supreme command over mainland, at Zanzibar.—April 8.  
British Central African Co., established in London.—April 11.  
Albany Evening Journal sold to proprietor of Albany Express.—April 3.  
Alien contract labor law, collector of customs at Niagara Suspension Bridge recommends U. S. District Attorney to prosecute Michigan Cer. Co. Grand Trunk and West Shore railways for violation of Alien contract labor law.—April 6.  
Alsacian, 140, b. for failing to report for service in German army.—April 4.  
American Bell Telephone Co., John A. Hudson elected president.—April 2.  
Andover, N.Y., rich strikes of oil made.—April 8.  
Arctic seas, exploration to, Everett Hon. J. W., Count de Sanvillia and J. Young leave on trip of exploration to Arctic seas.—April 15.  
Argentine Republic, premium on gold reaches 64 per cent.—April 9.  
Astronomical, Prof. Holden, of Lick Observatory, gives an approximate orbit by Prof. Schubert, of the comet discovered on March 31st by Mr. Bernard.—April 9.

Ottawa, writes:  
"Index," which  
will take partic-  
es of speeches of  
h was delivered,  
s, and I may add

Enclosed please  
to the "Index of  
you may meet with  
re valuable every

trate you most  
ting the "Index"  
on your success  
own heart. My  
up as thoroughly

ANADA, writes:—  
will be valuable fo

A Public Ledger,  
re I has long been

—Allow me to  
e. The idea and

" writes.—"I find  
line in looking up

CIATION, writes:—  
Current Events,"  
do not hesitate to  
e. The amount of  
ed by one hundred

the Index are  
y the dates of

form a complete  
first issue in

current month

large number of  
published in  
its conten-  
indulge in the

or half yearly

NTREAL, Que.

stock market

Atlanta, Ga., violent storm, fall of wall killing firemen Leach and Howell and several others.—April 24.

Australia, Melbourne, Dillon John, M.P., addresses a monster meeting at.—April 30.

AUSTRIA.—Emperor purchases Mayerling estate, owned by late Crown Prince Rudolf, the thing to be turned into a nunnery.—April 10.

Empress attacked by insanity, rumours of, desire of Emperor to abdicate in favor of his nephew.—April 14.

Vienna, serious rioting arising out of strike of trolley-car drivers.—April 20.

Government serves notice upon tramway companies that themselves and other property will be sequestered unless reforms promised their employes be completed by May 15th.—April 30.

Ayre Hon. C., member of Legislative Council of Newfoundland, death of.—April 12.

Bankrupt, London, Eng., Lord Francis Cecil, second son of Marquis of Exeter.—April 9.

Banks, Anoka, Minn., First Nationalist bank closes its doors.—April 6.

Banks, Montreal, Bank of, declaration of dividend of five per cent. straight.—April 24.

Banks, Yokohama specie Bank declares dividend of 20 per cent. per annum.—April 5.

Barley, Canadian, *The Brewers Journal* announces result of expert's test.—April 24.

Barnum, Hon. W. H., chairman of National Democratic Committee, death of, at Lime Rock, Conn.—April 30.

Bate Mr. C. T., ex-Mayor of Ottawa, death of.—April 9.

Battenburg, Prince Alexander of, having furnished satisfactory explanation to the Emperor of Austria on the subject of his marriage, receives permission to take up his residence at Gratz.—April 10.

Battersby Mrs. Hannah, largest woman in the world, death of, at Philadelphia.—April 15.

Bavaria, King Otto, demented Monarch, 41st anniversary of his birth celebrated at Munich.—April 37.

Belgium, Brussels, Boulanger attends soirée at deputy Somyre's residence.—April 10.

Belgium, Brussels, Boulanger Gen., present at soirée given Mr. Somyre.—April 11.

Belgium, Boulanger, Government decides to send second note to Boulanger that he will not be allowed to conspire against France.—April 19.

Bennington, Va., liquor raids result in closing of hotels.—April 12.

Berlin, Ont., chief of police instructed to ring town bell at 9 p.m. every evening, and arrest all children under 15 years of age found on streets after that hour.—April 9.

Birba, Sweden, Crown Princess gives birth to third son.—April 20.

Blizzard, Harrisonburg, Va., great damage done.—April 6.

Boulanger and party leave Brussels for England.—April 23.

Breach of promise, New York, Tolten Clara, gets verdict of \$15,000 against C. H. Reed, proprietor of Hoffman House, for breach of promise.—April 2.

Bright John, late, U. S. Senate passes resolution expressing sorrow at death of.—April 1.

Bright, John, M.P., Rochdale, committee decide to erect bronze statue of.—April 12.

British Columbia, Provincial Parliament, business of session ended.—April 5.

Bucket shops, Toronto, Priestman bucket shop case, prisoners discharged.—April 18.

Cambridge, Duchess of, death at London, Eng.—April 6.

Canada Asbestos and Antimony Company, petition granted by Justice Stirling, London, Eng., to wind up.—April 15.

Canada North West Land Company, meeting at London, Eng., Thomas Skinner elected as chairman.—April 16.

CANADA, PARLIAMENT OF.—Commons, death of Hon. J. H. Pope, announced by Sir John Mecklin.—April 1.

Public accounts committee, Mr. Henry Smyth examined.—April 2.

Sir Richard Cartwright and the last loan, estimates debated, immigration.—April 2.

Senate, Morrisburg and New York Railway incorporation bill thrown out.—April 2.

Committee on Railways and Canals, bill to compel Toronto Telegraph, Telephone and Electric Light Companies to put their wires underground thrown out.—April 3.

Commons, Franchise Act amendment bill, stormy discussion, bill read a second time, Committee on bill, Lower divorce bill thrown out.—April 3.

Senate, Behring Sea proclamation, discussion of.—April 3.

Commons, Pope late Hon. Mr., eulogies pronounced upon.—April 4.

Senate, Commercial Union, Senator Wark moves resolution on.—April 4.

## CANADA, PARLIAMENT OF.—Continued.

Canadian Pacific Railway bill and estimates considered. Bill to amend fisheries act read second time.—April 5.

Commons, importation of fish in bond for subsequent exportation, discussion on, Canadian Pacific Ry. bill passed in committee, combines bill referred to committee on banking and commerce.—April 9.

Commons, bill to amend Fisheries Act passes third reading; Franchise bill passes second reading; Postal Act passes second reading; Customs Act amendment bill considered.—April 9.

Commons, last loan discussed, Sir Richard Cartwright's want of confidence motion lost.—April 10.

Commons, Cape Breton Ry. discussed, estimates, house in committee on.—April 11.

Commons, estimates for Inland Revenue, Post Office and Dominion Lands considered.—April 12.

Commons, Mr. Clarke Wallace's bill on combines before committee.—April 12.

Commons, Toronto Board of Trade bill passed; Northwest Territory bill to consolidate and amend acts respecting, read first time; general inspection act bill to amend, read first time. Divorce bills, Bay well Ward, Mickleton and Lowry passed. Summary convictions act bill to amend; and expropriation of lands bill for, passed. Franchise bill passed. Post office bill passed.—April 15.

Commons combines bill reported by committee on banking and commerce.—April 16.

Commons, customs laws defence by Hon. Mr. Bowell, Mr. Folter's amendment defeated.—April 16.

Labor Commission, two reports of, laid before Parliament.—April 16.

Commons, steamship subsidies considered.—April 18.

Commons, extradition bill discussed. Bill to amend Inland Revenue act passes, also General Inspections Act amendment bill, also loans to Menonites Immigrants bill, Copyright act discussed.—April 20.

Commons, British Columbia coast, defence of; milk bill amendments adopted; mail subsidy resolutions adopted; Combines bill reported for third reading; house in supply.—April 22.

Commons Extradition bill, Copyright bill and combines bill passed. Mr. Barron's motion on sale of timber limits to Mr. Robillard.—April 23.

Commons, supplementary estimates presented to House.—April 23.

Commons, estimates and supplementary estimates discussed.—April 24.

Commons, Mr. McCallum's bill to amend Railway Act thrown out.—April 24.

Commons, House in supply; St. Mary's Bridge Company and railway subsidies considered.—April 27.

Commons, short line subsidy discussed.—April 29.

Commons, several important Government measures disposed of. The combines bill passed; Mr. Charlton and his Jesuit motion.—April 30.

Public accounts committee, Mr. Webster, travelling immigration agent, examined.—April 9.

Senate, debate on Senator Wark's motion regarding discrimination in duties against Mother country by Canada.—April 8.

Senate, amendment added to bill restricting use of fire-arms; bill introduced making penal escape from industrial school.—April 9.

Senate, Steamship Inspection Act passed; bill on unseaworthy ships passed.—April 11.

Senate, Adulteration Act, bill to amend, withdrawn.—April 15.

Senate, Royal assent given a number of bills.—April 16.

Canada Cotton Company, annual meeting at Cornwall.—April 3.

Canadian Asbestos and Antimony Co., petition presented to High Court of Justice, England, to wind up same.—April 5.

Canadian Cattle Co., annual meeting held at Aberdeen.—April 8.

Carnegie Andrew, speaks at Harrisburg, Pa., on the Industries of Pennsylvania.—April 8.

Catholic Congress assemblies at Madrid.—April 24.

Catholic Congress at Madrid adopts resolution demanding restoration of temporal power to the Pope.—April 29.

Centennial Celebration, United States.—April 29, 30.

Chamberlain Joseph, M.P., speaks at Birmingham on Irish plans of Government.—April 24.

Chapleau Hon. J. A., arrives at New York from Europe.—April 21.

Chevrenl Michael Eugène, distinguished French chemist, death of.—April 9.

Chicago, police officer Woodville shot by a burglar, Woodville shoots one of the burglars fatally.—April 9.

Chicago, panic at Centennial Celebration, large numbers of persons injured.—April 30.

Chino Mr., ex-Senator, death of, at Quebec.—April 27.

CHIN  
Chine  
Chole  
Chole  
Chochr  
Coboe  
Coke,  
Collier  
Collier  
Congo,  
Orema  
Uresce  
CRIMF  
Al  
Al  
Ab  
Ab  
Ar  
Ar  
Co  
Def  
Def  
Def  
Def  
Def  
Def  
Dy  
Em  
Em  
Em  
For  
Y  
Rob  
Rob  
Rob  
Rob  
P  
D  
D  
Rob  
Rob  
Rob  
Rob  
G  
Custom  
c  
Custom  
A  
T  
Cyclone  
b  
Cyclone  
Carym  
Dakota  
Dayton  
DEATH  
AF

considered. Bill to  
at expiration, dis  
committee, combines  
force.—April 9.  
reading; Franchise  
and reading; Cus  
light's want of con  
in committee  
office and Division  
before committee.—  
thwest Territor  
first time; general  
force bills, Bay sell  
y convictions act  
passed. Franchise  
banking and com  
well, Mr. Motter's  
liament.—April 16.  
and Inland Revenue  
ent bill, also loans  
cessed.—April 20.  
bill amendments  
business bill reported  
mbines bill passed.  
Mr. Robillard.—  
use.—April 23.  
discussed.—April  
ct thrown out.—  
pany and railway  
disposed of. The  
motion.—April 30.  
ling immigration  
discrimination in  
8.  
fire-arms; bill in  
ot.—April 9.  
seaworthy ships  
—April 15.  
16.  
—April 3.  
d to High Court  
—April 8.  
untries of Penn  
ng restoration of  
Irish plans of  
—April 21.  
iat, death of—  
ville shoots one  
bers of persons

CHINA.—Secretary Blaine receives despatch from Charles Denby, U.S. Minister to Chioa, relative to anti-foreign riots at Ching-Kiang on February 6.—April 6.  
Chinese exclusion, Won-Kwang-Pri, formerly of Chinese Embassy at Washington, advocates the expulsion of every American in the service of China.—April 8.  
Cholera, Philippine Islands, epidemic of, 1,000 fatal cases.—April 17.  
Cholera, Hog, West Liberty, Va., outbreak of.—April 6.  
Cochrane Ranch Company gives notice of intention to increase capital stock from \$250,000 to \$400,000.—April 12.  
Cohoes, N. Y., Democratic riot at municipal elections.—April 5.  
Coke, Pennsylvania, movement on foot to form trust.—April 4.  
Collieries, Northumberland, Eng., nine masters refuse 10 per cent. advance to wages demanded by colliers.—April 7.  
Collieries, Wilkesbarre, Pa., 16 collieries resume work.—April 5.  
Congo, State Government receives report on the exploration of River Zomai, an affluent of the Congo.—April 5.  
Cremation, Berlin police decide it to be illegal, and incineration of corpses is forbidden.—April 6.  
Crescent Bay, terrible storm, Thompson Mrs., killed by a falling tree, and Thompson Mr. knocked senseless.—April 4.  
CRIMES.—Bigamy, Belleville, Ont., Joseph Douglas sentenced.—April 1.  
Absconders, Bavaria, Count Papheim absconds to America.—April 10.  
Absconders, St. Paul, Minn., Smith Walter B., teller of Second National Bank, arrested at St. Louis, Mo.—April 15.  
Absconders, Neenah, Wis., Theodore Paepke, city treasurer.—April 23.  
Absconders, Sandwich, Mass., Samuel Fessenden, treasurer of Cape Cod Canal Company.—April 19.  
Arson, Listowel, Ont., five buildings fired, three persons arrested.—April 15.  
Counterfeiters, Deseronto, Ont., Frank Conger arrested.—April 2.  
Defaulters, Hillier Township, Ont., John Young, treasurer, short in his accounts.—April 29.  
Defaulter, Neenah, Wis., Theodore Paepke, city treasurer.—April 23.  
Defaulters, New York, Harvie committed for extradition at Halifax.—April 4.  
Defaulters, Montreal, Lapiere Chas., accountant of City Hall.—April 18.  
Defaulter, Sandwich, Mass., Samuel Fessenden, treasurer of Cape Cod Canal Company.—April 19.  
Dynamiting, New York, Labor unionists arrested, charged with blowing up Stevenson's brewery on Tenth Avenue.—April 6.  
Embezzlers, St. Paul, Minn., Smith Walter B., teller of Second National Bank, arrested at St. Louis, Mo.—April 15.  
Embezzlement, Toronto, Roland Gideon Israel Barnett found guilty.—April 18.  
Forgery, Venezuela, nephew of Guzman Blanco, ex-President of Venezuela, arrested while trying to escape to United States.—April 5.  
Robbery, Chicago, police officer Woodville shot by burglar.—April 9.  
Robbery, East Liverpool, Ohio, residence of Robert McBane broken into, McBane nearly killed.—April 8.  
Robbery, Hungary, Still, wine store keeper, crushed to death in wine press by robbers.—April 7.  
Robbery, Indian Head, Manitoba, attempt to rob the C.P.R. and Dominion Express Company's office of a large sum of money.—April 6.  
Robbery, Rat Portage, Chief of Police, arrested for stealing furs from Hudson Bay store.—April 27.  
Robbery, Somerset, Pa., 12 members of gang of desperadoes captured.—April 30.  
Robbery, Toronto, Frank Carson of Detroit and Frank Parker of Galveston, two noted American thieves, arrested.—April 29.  
Customs, U.S., Edward Joel R., appointed by President collector of customs at New York.—April 5.  
Customs, U.S., New York, extensive scheme of smuggling carried on by Alford & Sons, of Paris and Fifth Avenue, unearthed by Special Treasury Agent Simmons.—April 5.  
Cyclone, Long Lake, N.W.T., much destruction, several houses and barns blown down.—April 7.  
Cyclone, Norfolk, Pa., immense amount of damage.—April 6.  
Jairymen, Ottawa, convention of, meet at.—April 9.  
Dakota, Prairie fires, great damage and heavy losses.—April 6.  
Dayton, Ohio, natural gas turned into pipes.—April 18.  
DEATHS.—Cambridge Duchess of, at London, Eng.—April 6.  
Affect Mrs., widow of Capt. John Affect, death of, at Halifax, N.S.—April 11.

## DEATHS—Continued.

Ayre Hon. C., member of Legislative Council of Newfoundland.—April 12.  
Bate Mr. C. T., ex-Mayor of Ottawa.—April 9.  
Barnum Hon. William H., chairman of National Democratic Committee at Lime Rock, Conn.—April 30.  
Beardy Chief, of Cree reserve, Duck Lake.—April 18.  
Brinkmann Dr., Bishop of Munster.—April 16.  
Chevreul Michael Engène, distinguished French chemist.—April 9.  
Chinic Mr., ex-Senator, death of, at Quebec.—April 27.  
Don Sebastian Lerdo Tjada, ex-President of Mexico, at New York.—April 21.  
Douglas P. D., assistant secretary Department of Interior, Ottawa.—April 20.  
Dunsuir Hon. Robert, President of the Council at Victoria, B.C.—April 12.  
Ely Marquis of, in Italy.—April 3.  
Farwell Leonard J., ex-Governor of Wisconsin, at Granite City, Mo.—April 11.  
Fielding John A., soldier of 1812, dies at Laurens county, aged 110 years.—April 15.  
Higgins Most Rev. Andrew, Bishop of Catholic diocese of Kerr.—April 30.  
Kennedy Rev. Benjamin Hall, Regius, Professor of Greek at Cambridge, Eng.—April 7.  
Hatch Major General, an old hero of the civil war, at Fort Robinson, Neb.—April 11.  
McDonald Rev. Angus, of Prince Edward Island.  
Martell M., head of great distillery firm, at Cognac.—April 2.  
Milton General, Irish Nationalist, and on staff of New York Herald, death of, at New York.—April 10.  
Ouseley Rev. Sir Frederick Arthur Gore, professor of music in England.—April 8.  
Pierre Rev. Dr. Bradford, Methodist divine, at Newton, Mass.—April 15.  
Plater Count, death of, at Kitchberg.—April 24.  
Pope Colonel, of British regulars.—April 13.  
Pope Hon. J. H., Minister of Railways at Ottawa.—April 1.  
Princess Eugenia, sister of King of Sweden.—April 23.  
Rosa Carl, musical director, at Paris, France.—April 30.  
Smith A. I., secretary of defunct Winnipeg Call.—April 19.  
Taylor, Rear Admiral W. R., at Washington.—April 14.  
Usher John P., secretary of Interior under President Lincoln, death of, at University Hospital, Philadelphia.—April 13.  
Von Sauer Dr., formerly physician to late Emperor William.—April 9.  
Vrooman Henry, prominent lawyer of California.—April 7.  
Wagener Frederick William Hermann, German statesman, death of.—April 23.  
York Lionel, stone contractor, drops dead in Toronto.—April 13.  
Dillon John, M.P., addresses a monster meeting at Melbourne, Australia.—April 30.  
DIPLOMATIC.—Germany and Rome, Emperor William opposes Bismarck's proposal for appointment of Papal Nuncio, at Berlin.—April 20.  
Paucafote Sir Julian, British Minister to Washington, arrives at New York.—April 21.  
Whitelaw Reid, United States minister of France takes oath of office.—April 18.  
Distillers, Dublin, syndicate of, formed, Jamieson's refuse to join.—April 5.  
DIVORCE.—Count Featlich of Vienna sues for separation from his wife on the ground of adultery.—April 12.  
London, Eng., Boucault Agnes, applies to Divorce court for enforcement of payment of alimony from her late husband Dion Boucault.—April 9.  
London, Eng., Dion Boucault's appeal against order enforcing dismissed.—April 16.  
Douglas P. D., assistant secretary of Department of Interior, death of, at Ottawa.—April 20.  
Dumont Gabriel, arrives at Winnipeg from Batocbe, and in interview says claims of half breeds must be settled by Government.—April 24.  
Dunsuir Hon. Robert, President of the Council, dies at Victoria, B.C.—April 11.  
Dynamite gun "Vesuvius," preliminary trial at Philadelphia.—April 4.  
Earthquake, Cairo, slight shock at.—April 23.  
Earthquakes, Greece, violent shocks in Epirus.—April 11.  
Earthquakes, Hayti, great damage at Port Depaix.—March 28, rep. April 12.

Earthquake, Switzerland, sharp shocks.—April 30.  
 East Liverpool, Ohio, McBane Robert, nearly killed by burglars.—April 8.  
**ECCLESIASTICAL.**—Brampton, Ont., Rev. Mr. Dobbin, Presbyterian Minister, tried and fully exonerated.—April 6.  
 Bramford, Ont., Presbyterian Synod of Hamilton and London meet at.—April 6.  
 Brinkmann Dr., Bishop of Munster, death of.—April 18.  
 Catholic congress assembles at Madrid.—April 24.  
 England, Kennedy Rev. Benjamin Hall, Regius Professor of Greek at Cambridge University, death of.—April 7.  
 Higgins Most Rev. Andrew, Bishop of Catholic diocese of Kerr, death of.—April 30.  
 McDonald Rev. Angus, of Prince Edward Island, death of.—April 30.  
 Newton, Mass., Pierce Rev. Dr. Bradford, Methodist divine, death of.—April 19.  
 Ottawa, Duhaime Archbishop arrives from Rome.—April 9.  
 Quebec, Presbyterian Synod of Montreal and Ottawa meet at.—April 16.  
 Rome, Mgr. Ferrata, Papal Nuncio at Brussels, succeeds Mgr. Agliardi as apostolic delegate for India, Mgr. Agliardi acts as Papal Nuncio at Munich in place of Mgr. Ruffascilla, who is ill. The Archbishop of Perugia succeeds Mgr. Ferrata as Papal Nuncio at Brussels.—April 17.  
 Toronto, Transfer committee of General Conference of the Methodist Church, meeting of.—April 4.  
**EDINBURGH.**—Parnell Mr., three meetings protest against conferring freedom of city upon.—April 22.  
 Edinburgh town council agrees to confer freedom of city on Mr. Parnell.—April 23.  
 Egan Patrick, Irish National League request Mr. Parnell to appoint committee to enquire into conduct of.—April 9.  
**EGYPT.**—Messenger to Suakim from Khartoum brings letters from Slatan Bay and members of Catholic Mission, also supposed head of Ras Alula Abyssinian general.—April 19.  
 Egypt, Nile falling rapidly.—April 5.  
 Port Halaib, force of Soudanese attack and defeat party of Egyptians from Suakim.—April 20.  
 Battalion of Egyptian troop and two gun-boats start to re-capture Halaib.—April 22.  
 Cairo, earthquake shock at.—April 22.  
 Sondan, uprising of Derivishes, Italian government rejects proposal of English government to join forces to suppress uprising.—April 30.  
**ELECTIONS.**—Birmingham, Eng., Lord Randolph Churchill declines to become candidate for vacant seat.—April 2.  
 Birmingham, Eng., Roseberry Lord, speaks at public meeting in favor of Liberal candidate.—April 6.  
 Birmingham, Bright John Albert, Liberal unionist, elected to succeed his father in representation of Central Division.—April 15.  
 Birmingham Central, Eng., correspondences between Mr. Joseph Chamberlain and Lord Randolph Churchill.—April 19.  
 Chicago, Municipal, considered to be illegal in consequence of decision of Supreme Court of the State.—April 8.  
 Chicago, Municipal, collapse of proposed scheme to declare election illegal.—April 8.  
 Cohoes, N.Y., Democratic riot at municipal elections.—April 5.  
 Compton County of, Prohibitionists meet at Johnville and name two candidates, Mr. Ives and Mr. Munro.—April 22.  
 Cokabre, Rufus Pope chosen as candidate by Liberal-Conservative Association.—April 25.  
 Cottonwood Falls, Mrs. Minnie Morgan elected Mayor and other ladies members of council.—April 2.  
 England, Rochester, Hugessen Mr., Gladstonian, returned.—April 16.  
 Municipal, Chicago, Cregier (Democrat) elected Mayor.—April 2.  
 Okaloosa, Fla., female candidates successful at municipal election.—April 2.  
 Ely, Marquis of, death of, in Italy.—April 3.  
 Emigrants, Bremen and Hamburg, 5,300 sail for New York.—April 11.  
 Emigrants on steamer "Nuoland," which collided off Leachy Head, and which put into Southampton for repairs, forbidden to land.—April 8.  
 Emigration, Great Britain, President of Local Government Board moves in House of Commons for, and obtains select committee of enquiry into.—April 4.  
 Emin Pasha, Arabs arrive at Stanley Falls, and reports Stanley and Emin heard from in February, as marching on Zanzibar, arrives received at Brussels.—April 4.  
 Emin Bey, Sir Francis De Winton, president of Emin Bey relief committee, doubts truth of story brought to Stanley Falls by Arabs.—April 5.

**ELECTIONS.**—Continued.  
 Emin Bey, despatch to Brussels from Zanzibar says, rumour that Emin Bey and Stanley marching in direction of Zanzibar is Arab invention.—April 9.  
 Emin Pasha, positive information received by British foreign office that Stanley and Emin had second meeting, and defeat army of Khalifa.—April 23.  
 Erhardt Joel R., appointed by President collector of customs at New York.—April 5.  
 Evictions, Iowa, Fort Dodge, 17 river land settlers, charged with conspiracy, arrested.—April 5.  
**FAILURES.**—Anoka, Minn., First Nationalist bank closes its doors.—April 6.  
 Berlin, Teller & Co., dealers in grain.—April 12.  
 Boston, Bellings & Eaton, leather dealers.—April 11.  
 Boston, Isaac Rich & Co., oldest fish house.—April 5.  
 France, Paris, M. Coullissier, broker in rentes.—April 3.  
 Hamilton, Thompson E. J., & Co., wholesale jewellers.—April 12.  
 London, Eng., Lord Francis Cecil, second son of Marquis of Exeter, declared bankrupt.—April 9.  
 New York, American Meat Company.—April 12.  
 New York, Callender Insulating and Water Roofing Company.—April 8.  
 New York, Kell & Co., importers of woollens and plushes.—April 12.  
 Farmers' Club, England, Wesley Richards advocates American system of selling cattle by live weight, the meeting agrees to recommend its adoption.—April 30.  
 Farwell, Leonard J., formerly governor of Wisconsin, death of, at Granite City, Mo.—April 11.  
 Fasting, Train George Francis at New York.—April 24.  
 Fielding John A., soldier of 1812, dies at Laurens county, aged 110 years.—April 15.  
 Fisheries, Canadian, Annual report of Department of fisheries for 1888, issued.—April 11.  
 Fishery Question, Senator Trye not satisfied, interview in New York Herald's Washington despatch.—April 9.  
**FRANCE.**—Boulanger flees to Brussels.—April 2.  
 Boulanger, proclamation received by the *Figaro* from Brussels, from the General.—April 3.  
 Boulanger's flight, National Committee of Boulangerist party explains reason for his conduct.—April 4.  
 Boulanger interviewed by New York Sun's Brussels correspondent.—April 4.  
 Boulangerist trial, Senator Montesquieu-Fezersac declines to sit as member of exceptional tribunal.—April 6.  
 Boulanger interviewed at Brussels as to his return to France.—April 8.  
 Boulanger, trial of, by Senate, meeting of members of legislative party of the right adopts protest against.—April 13.  
 Chamber of deputies, proposal of Senate to prosecute summarily payors guilty of libelling Government officials rejected.—April 2.  
 Chamber of Deputies asked by Ministry to sanction prosecution of Boulanger.—April 3.  
 Chamber of Deputies, Boulanger's prosecution sanctioned.—April 4.  
 Chamber of deputies, bill prescribing mode of procedure to be followed by Senate on trial of Boulanger carried.—April 9.  
 Chamber of deputies, Chevrolat Muns., 10,000 francs voted by, to defray expenses of funeral.—April 11.  
 Chamber of deputies adjourns until 14th May.—April 11.  
 Comptoir D'Escompte, provisional directors sign a deed constituting a new company.—April 27.  
 Meeting of Comptoir D'Escompte at Paris, agrees to form new company, meeting ends in confusion.—April 30.  
 Elections for members of Local Councils.—April 16.  
 Gilly M. Numa and Savin M., sentenced to prison in Paris for libelling ex-Minister Raynal.—April 19.  
 National Republican Association, address delivered by M. Ferry before, at Paris.—April 11.  
 National Party, Deputy Vacher elected Vice-President in the place of Boulanger.—April 18.  
 Patriotic League, leaders of, arraigned for trial before correction tribunal at Paris.—April 2.  
 League of Patriots, correct local tribunal acquits Senator Naquet and four Deputies, but fines them 100 francs for belonging to society not authorized by law.—April 6.  
 Patriotic League, trial of leaders, speech of assistant procurer; M. Naquet's defence.—April 3.  
 Paris Police search residences of General Boulanger, Count Dillon, and M. Rochefort, and seize large number of papers.—April 16.

## FRANCE—Continued.

Paris, Revisionist committee give grand banquet, speech prepared by Boulanger read.—April 6.  
 Revolutionary relics, exhibition of, opened in Paris.—April 18.  
 Senate, Boulanger trial, preliminary proceedings, a stormy sitting.—April 12.  
 Senate, trial of Boulanger and associates begun.—April 12.  
 Senate, M. Merlin elected president of commission to conduct trial of Boulanger.—April 13.  
 Senate commission, Boulanger trial, M. Cambon, French Ambassador at Madrid, examined.—April 19.  
 Versailles, banquet at, Boulanger's speech read by Deputy Laguerre.—April 14.  
 Versailles, MM. Laguerre and Herisse arrested on leaving Boulanger banquet.—April 14.  
 Warrants issued for arrest of General Boulanger, Count Dillon and M. Rochefort.—April 10.  
 Freight Agents, Bethlehem, Pa., meeting of agents of several railroads and reduce lots on anthracite coal.—April 3.  
 Gary, Dak., sand blizzard rages at.—April 3.

GERMANY.—Alsations, 149, fined for failing to report for service in German Army.—April 4

Berlin, *Volks Zeitung*, proprietor of, receives permission from Government to resume publication.—April 9.  
 Bismarck issues order defining responsibilities of commanders of warships with respect to requests of consuls abroad.—April 18.  
 Cremation, Berlin, police decide it to be illegal, and incineration of corpses is forbidden.—April 6.  
 Emperor opens at Berlin, exhibition of appliances for prevention of accidents.—April 30.  
 Papal Nuncio at Berlin, Emperor William opposes Prince Bismarck's proposal for.—April 20.  
 Prince Bismarck returns thanks to Central Manufacturers' Association for birthday congratulations.—April 2.  
 Puttkamer Dr. Von, summoned to Herrenhaus by German emperor, as a mark of renewed confidence.—April 3.  
 Reichstag, Naval Secretary refers to loss of warships at Samoa, and speaks as to situation there.—April 3.  
 Reichstag adjourns until May 7.—April 12.  
 Schellendorf Count Von, retires from ministry of war, and is succeeded by General Verdz Du Vernois.—April 10.  
 Socialists, Berlin Courts decide that all the recent dispersals of Socialist meetings by the police were illegal.—April 5.  
 Stuttgart, statues of Prince Bismarck and Count Von Moltke unveiled.—April 7.

Gloicester, N. I., P. O., rooms, gambling houses and unlicensed saloons closed by the Mayor.—April 16.  
 Gold, Franklin County, Va., discovery of.—April 23.  
 Gold, Argentine Republic, premium on, reaches 64 per cent.—April 9.  
 Grain vessels, Kingston, Ont., first fleet arrives at.—April 17.  
 Greece, Epirus, violent earthquakes reported in.—April 11.  
 Harrisonburg, Va., blizzard causes extensive damage.—April 6.  
 Hawaii, bark "C. W. Bryant" seized by Government at Honolulu for smuggling opium.—March 23, reported April 13.

HAYTI.—Commission appointed by Legitime visits Hippolyte, who expresses himself pleased with terms submitted.—April 3.

Hayti, Fort Depaix, earthquake, great damage done by.—March 28, reported April 12.

Hayti, heavy fighting between St. Marc and Gonaives.—March 28, reported April 12.  
 Legitime gains great victory over Hippolytes forces on March 30th, reported in *Le Moniteur*, official organ of Haytian Government.—April 4.

Captain of steamer "Caroline Miller" arrives at New York, and reports that Legitime's forces burn town of Petite Riviere, on 7th instant.—April 23.

Hickson Joseph, General Manager Grand Trunk Railway, gives his views on the question of existing freight difficulties to reporter of *New York Times*.—April 11.

Hog Cholera, West Liberty, Va., outbreak of.—April 6.

Holland, parliament, Regency asked for by Prime Minister.—April 2.

Holland, parliament agrees to the appointment of a regency.—April 3.

Iowa, Iowa, Marshals sent to make evictions from river lands met by armed mob of settlers and driven from the field.—April 5.

Hungary, Diet, Army bill adopted by Upper House.—April 5.

Hungary, Southern, visited by terrible storm demolishing many houses.—April 5.

Hungary, Sill, wine store keeper, crushed to death in wine press by robbers.—April 7.

Hungary, famins raging at Blezswag and Bistriz, hundreds dying.—April 19.

Illinois legislature, Lower house, Illinois and Michigan canal, bill passed for widening and deepening.—April 11.

Illinois House passes Anti-trust bill.—April 18.

Immigrants, 400 strolling musicians arrive in New York from Europe.—April 3.

IMPERIAL PARLIAMENT.—Commons, Naval proposals of first Lord of the Admiralty approved.—April 1

Commons, Naval proposals, Mr. Childer's motion against financial method rejected.—April 4.

Commons, Manitoba guarantee of Bonds to Winnipeg and Hudson Bay Railway, Baron De Worms replies to question of Mr. Beckett.—April 4.

Commons, Immigration, President of Local Government Board moves for and obtains select committee of enquiry into.—April 4.

Commons, Vaccination, commission appointed to enquire into Vaccination Acts.—April 5.

Commons, Scotland local government for, bill providing for, introduced by Lord Advocate.—April 8.

Commons, Scottish home rule, motion for, rejected.—April 9.

Commons, bill as to courts fixing rents, and as to arrears introduced by Mr. Crilly, M.P. for North Mayo, and rejected.—April 10.

Commons, Solicitor General for Ireland denies that Marquis of Londonderry intends to resign office of Lord Lieutenant of Ireland.—April 10.

Commons, sugar convention bill introduced by Baron Henry de Worms.—April 11.

Commons, Ireland, circular sent to Irish police to collate all secret information regarding the doings of members of National league, debate on.—April 12.

Commons budget introduced by Chancellor of the Exchequer.—April 15.

Commons, Spirit drinking in India, motion of Samuel Smith, M.P., censuring government for permitting, carried.—April 30.

Lords, Earl of Morley, Liberal, elected chairman of committees.—April 4.

India, Mr. Crawford, British Commissioner of central division of Bombay presidency, dismissed.—April 17.

India, spirit drinking in, motion of Samuel Smith, M.P., in British House of Commons, censuring government for permitting, carried in British House of Commons.—April 30.

Indians, Dumont Gabriel arrives at Winnipeg from Batoche, and in interview says claims of Half-Breeds must be settled by Government.—April 24.

Indians, Guthrie Oklahoma, rising of, on account of boomers.—April 23.

Indians, Chief Beardy of Cree reserve, Duck Lake, death of.—April 18.

Indian Troubles, St. Paul, Minn., arrival of Gabriel Dumont in Saskatchewan district causes commotion.—April 15.

Indians, Moresley Islands, five seamen of schooner "Koderack" killed by Indians, schooner reaches New Dungeness, W.T.—April 2.

Indian troubles, Gabriel Dumont addresses his old followers at Batoche.—April 9.

Interstate Commerce commission begins hearing case against Grand Trunk Railway at Washington.—April 4.

Interstate Commerce commission, Chairman of, rules in the case of the Chicago and Atlantic Railway, that a road has no authority for making a higher rate over a connecting line than the one actually made by that line.—April 5.

Interstate Commerce Commission summons officers of railroad companies in middle and Eastern States to appear before commission on May 3.—April 15.

Interstate Commerce Commission decides at Washington that Grand Trunk Railway must obey law's provisions.—April 20.

Iowa evictions, Fort Dodge, 17 river land settlers, charged with conspiracy, arrested.—April 5.

IRELAND.—Dublin, Mr. Kithrife's appeal against conviction of offences under Crimes Act heard, conviction confirmed.—April 4.

Dublin, O'Brien's appeal from sentence heard, sentence reduced.—April 10.

Dublin, Libel suit, Stokes against Dublin *Freeman's Journal* results in verdict for plaintiff.—April 10.

Falcarragh, 13 families again evicted.—April 20.

Falcarragh, Conybeare Mr., M.P., summoned to appear before Court on charge of conspiring to oppose the law.—April 22.

Father McFadden's prosecution, Mr. Gladstone writes that Government has incurred very grave responsibility.—April 19.

Funicane Mr., M. P., sentence on, under Crimes Act confirmed, on appeal.—April 9.

Harrison, a student of Balliol College, Oxford, arrested for supplying food to besieged tenants.—April 17.

## IRELAND—Continued.

Harrison Prof., committed for trial for assisting beirged tenants at Gweedora.—April 18.

Home Rule, Salisbury Lord, speaks at Bristol, and defends course pursued by his government.—April 23.

Landowne's Marquis of, estate. Forty tenants receive notices of eviction.—April 13.

Londonderry Marquis of, intimates his desire to resign viceroyship.—April 9.

Londonderry's Lord, resignation announced by him at banquet at the College of Physicians, of Dublin.—April 27.

Luggacurran, Mahar Rev. John, served with summonses for offences under Crimes Act.—April 1.

Neagah, Father Morris and Father Cunningham sentenced under Crimes Act, they appeal.—April 10.

O'Brien enters libel suit, against Lord Salisbury, for remarks made in speech at Watford *vide* London *Weekly Despatch*.—April 14.

Olphel estate, evictions on.—April 13.

Olphel evictions, all evicted persons become re-possessed of their homes.—April 15.

Plans of British Government concerning, Chamberlain Mr. Joseph M. P., speaks at Birmingham concerning.—April 24.

Skough, Piltown, National demonstration held at, crowd charged by Hussars.—April 21.

Sentences upon Mr. Cox, M. P., for East Clare, and Mr. Tuly, editor of Roscommon *Herald*, under Crimes Act, reduced upon appeal to six weeks each.—April 5.

Sheehy Mr., M. P., sentences on, under Crimes Act reduced on appeal to one term of five months.—April 9.

Sheehy David, M. P., for South Galway, confined in cell, and placed on bread and water diet, for refusing to perform menial work in prison.—April 13.

Vandeleur and Clare tenants, Sir Charles Russell consents to act as arbitrator between.—April 9.

Vandeleur's estate, tenants on mediation of Sir Charles Russell accept offer of reinstatement on payment of years rent less 2 per cent.—April 16.

Irish National League request Mr. Parnell to appoint a committee to enquire into attitude recently assumed by Patrick Egan.—April 9.

ITALY—Deputy Costa, a Socialist, sentenced to imprisonment for being concerned in recent street riots.—April 5.

Chamber of Deputies, death of King John of Abyssinia, Prime Minister makes statement as to Italy's position.—April 5.

Jamaica Railway System, sale of, by Colonial government to American syndicate.—April 3.

Japan railway company receives permission from President of State to double the line between Mens and Omya.—April 5.

Japan, Yokohama specie bank declares dividend of 20 per cent. per annum.—April 5.

Jenkins Rev. E. E., conferment of degree of Doctor of Laws at Queen's University, Toronto.—April 24.

Kennedy, Rev. Benjamin Hall. Negius professor of Greek at Cambridge, Eng.—April 7.

Kingston, Ont., Exhibition of fine arts opened by Sir Charles Tupper.—April 2.

Kingston, Ont., first fleet of grain vessels arrives at.—April 17.

Kingsville, Ont., Petroleum discovered at.—April 6.

LABOR—Unionists arrested in New York charged with blowing up Stevenson's brewery on Tenth Avenue.—April 6.

Labor Commission, Canadian, two reports laid before Parliament.—April 16.

Labor, Knights of, Toronto, General Master Workman Powderly addresses crowded meeting in Shaftsbury Hall.—April 15.

Laud Corporation of Canada, application granted at London, Eng., by Justice Stirling to reduce capital.—April 15.

LEGAL.—England High Court of Justice, petition presented to wind Canadian Asbestos and Antimony Company.—April 5.

Boston, Lawton Hannah R., obtains verdict for \$20,185 against Boston and Maine Railroad for injuries received in collision.—April 16.

California, Henry Vroman, prominent lawyer, death of.—April 7.

Ireland, libel suit of Stokes against Dublin *Freeman's Journal* results in verdict for plaintiff.—April 10.

London, Eng., Barnes Anglo-American troupe, Mr. Ledger, proprietor of the *Era*, £300 verdict for plaintiff for libel.—April 8.

London, Eng., Women on London County Council, Judges of Superior Court declare them ineligible.—April 13.

London, Eng., Canada Asbestos and Antimony Company, petition granted by Justice Stirling to wind up.—April 15.

## LEGAL—Continued.

London, Eng., Land Corporation of Canada, application granted by Justice Stirling to reduce capital.—April 15.

New York, injunction procured by Western Union Telegraph Co., against Mayor and Board of Electrical control of New York vacated by Court.—April 12.

New York, Tollen Clara, gets verdict of \$15,000 against O. H. Reed, proprietor of Hoffman House, for breach of promise.—April 2.

Nova Scotia, Supreme Court declares wholesale license clause of provincial law *ultra vires* of local legislature.—April 16.

Philadelphia, suit brought by heirs of late Dr. Scott Stewart, to upset legacy, for establishing hospital of Methodist Episcopal Church concluded in favor of Trustees of Hospital.—April 8.

Libel, London, Eng., case of Barnes Anglo-American troupe *vs.* Ledger, proprietor of *Era*, results in verdict for Plaintiff £300.—April 8.

Libel, New York, Russell Harrison, son of President Harrison, arrested in office of judge for libel on Ex-Governor Crosby.—April 11.

Libel, O'Brien enters action against Lord Salisbury for remarks made in speech at Watford, *vide* London *Weekly Despatch*.—April 14.

London County Council, Women declared ineligible to sit on board, by Judges of Superior Court.—April 13.

Long Lake, N. W. T., destructive cyclone at, several houses and barns blown down.—April 7.

Lonsdale Lord, Philadelphia *Engineer* publishes details of his travels.—April 8.

Lonsdale Lord, arrives at San Francisco.—April 23.

Lumber operators, St. John, N.B., meeting of, held, to discuss Lumber Inspection Act.—April 8.

Luxembourg, Chamber of Deputies, message of Duke of Nassau, accepting the regency, read and assented to.—April 8.

Luxembourg, Duke of Nassau, new regent receives enthusiastic reception.—April 10.

Luxembourg, Duke of Nassau takes oath of office.—April 11.

Magog Textile and Print Company, meeting of, at Montreal, Company ordered into liquidation.—April 8.

Mails, Canadian, British government office issues official notice that contract with Allans terminated, and that all Mails to go via New York.—April 16.

MARRIAGES.—New York "Captain" James Ellis of Salvation Army to "Staff Captain" Alexandria Leeds.—April 4.

Providence, R. I., Fedora King Levless marries George McLeod, son of a mechanic.—April 16.

Marshall, Minn., worst-wind storm ever experienced.—April 3.

Martell M., head of great distillery firm at Cognac, death of.—April 2.

Massachusetts, amendment to constitution prohibiting manufacture and sale of intoxicating liquors defeated.—April 22.

MEDICAL, Germany, Puttkamer Dr. Von, summoned to Herrenhaus by German Emperor, as a mark of renewed confidence.—April 3.

Germany, Dr. Von Sauer, formerly physician to late Emperor William, death of.—April 9.

Kingston, results of Royal Medical College examinations.—April 1.

Mexico, Congress opens.—April 1.

Mexico, four of the men arrested, on charge of being implicated in the deraiment of President Diaz's train, shot.—April 12.

Mexico, Don Sebastian Lerdo De Tejada, ex-president, death of, at New York.—April 21.

Millers, Oatmeal Millers Association of Ontario disbanded.—April 18.

MILITARY.—Germany, 140 Alsatians fined for failing to report for service in German Army.—April 4.

England, Field Battery of Hon. Artillery company celebrates return of its guns from Wuolwich by supper in London.—April 11.

Germany, Schellendorf Count Von, retires from ministry of war, and is succeeded by General Verdzis du Vernois.—April 10.

Hungary Army bill adopted by Upper House of Diet.—April 5.

Quebec, Pope Colonel, death of.—April 13.

Russia, Artillery officers arrested for plotting against Czar.—April 22.

St. Johns Que., Court Martial in case of Private Wells, of B company school of infantry.—April 24.

United States, Dynamite gun, Vesuvius, preliminary trial at Philadelphia.—April 4.

Milton General, Irish nationalist, and on staff of New York *Herald*, death of, at New York.—April 10.

Milwaukee, Margaret Kintson and three children burned to death.—April 2.

Miners in four pools along Monongahela river, excepting those employed by Homer and Roberts, resume work.—April 8.

Mining, Aurora mine, Coeberg range, Wis., fire raging in.—April 30.

Mining, Plymouth, Pa., Boston mine operated by Delaware and Hudson Canal Company caves in.—April 20.

Morley Mr. John, M. P., addresses his constituents at Newcastle, and presents objection to eight hours legislation.—April 24.

MORMONS, St. Joseph, Mo., World's conference of Latter Day Saints assemblies at.—April 7.  
 Conference, Salt Lake City, Utah, eviction of officers.—April 7.  
 Dale County, Ala., five Mormon missionaries whipped and driven from county.—April 15.  
 Statutes given at closing session of Mormon conference at Salt Lake City.—April 8.  
 St. Joseph, Mo., World's conference of latter day Saints adjourns.—April 11.  
 Morrison Donald, capture of, at Marsden, Quebec.—April 21.  
 Mount Carmel, Pa., riot between drunken Hungarians and Police, one Hungarian killed.—April 22.  
 MURDERS.—Guelph, Ont., Harvey triple murder case, Coroner's Jury return verdict of wilful murder against W. H. Harvey.—April 3.  
 Blue Run, Va., Frank Hancock kills his four children and hangs himself.—April 20.  
 Buffalo, N. Y., Clarina Dominy butchered by her husband Thomas Dominy, who commits suicide.—April 16.  
 Calgary, trial of "Lumbo" Fisk for murder of Urow squaw commenced.—April 9.  
 Calgary, Man., Fisk murder case, jury cannot agree, and prisoner remanded to next assizes.—April 13.  
 Fort Smith, Ark., Irwin William, Deputy U. S. Marshall, trial of Indian chief, Jack Spaniard, for.—April 9.  
 Fort Smith, Ark., five convicts sentenced to be hanged, viz., Jack Spaniard, Franz Capell, William Walker, Joe Martin and Elsie James.—April 29.  
 Guthrie, Oklahoma, three men killed by claim jumpers.—April 22.  
 Ilmborg, boy named Steinfatt found murdered and mutilated on the road.—April 8.  
 Hartford, Conn., Swift John H., hanged for murder of his wife.—April 17.  
 Ireland, story of murder of Bailiff Mullan at Coleraise, County Londonderry, contradicted.—April 6.  
 Macon County, N. C., wife, three sons and two daughters of W. P. Wood, farmer, murdered, and house burned.—April 22.  
 Megantic, Morrison Donald caught at Marsden, P. Q.—April 21.  
 Moreau Island, five seamen of schooner "Koderack" killed by Indians, schooner reaches New Dungeness, W. T.—April 2.  
 Navasato, Tex., Burchard shot and killed by Rev. Hall Miller.—April 7.  
 Navasato, McLeod Daniel, a negro, shot and killed by Rev. K. M. Lawson.—April 7.  
 Oklahoma, Martin kills another boomer, in a quarrel over a claim near Guthrie.—April 22.  
 River du Loup, P. Q., three Italians named Monaco arrested for attempting to murder fellow countrymen named Cugliano on Temiscouata railway.—April 12.  
 Ruanan Bay Islands, Rev. Henry Hobson, wife and young girl, natives of Jamaica, murdered by Joseph Burns.—April 16.  
 Savannah, Ga., Prince Law, negro, on Springfield plantation, kills his four year old child as a sacrifice to the devil.—April 11.  
 Titus County, Frank Shubze arrested for murder of J. R. King, farmer wife and children on December 10, 1888.—April 6.  
 West Farms, Mass., Joseph King, shot by Edgar King, his eldest son who commits suicide.—April 19.  
 Musicians, New York. Four hundred strolling musicians arrive from Europe.—April 3.  
 National Home Reading Circle Union, meeting at Lord Aberdeen's house, London, Eng., to form.—April 13.  
 National Reform Association in session at Pittsburg, Pa.—April 23.  
 NAVAL.—Britain naval proposals of first Lord of the Admiralty approved by House of Commons.—April 1.  
 American, English Naval Manoeuvres report of Committee in British Admiralty received at Washington, Admiral Sir Arthur Hood interviewed thereon.—April 8.  
 British, Duke of Edinburgh Commander-in-chief of Mediterranean Station offers to float British warship "Sultan" wrecked on island of Comino.—April 10.  
 British cruiser "Rapid" sails for Samoa.—April 2.  
 British man-of-war "Calliope," which escaped destruction in Apia Bay, arrives at Sydney, N. S. W.—April 4.  
 British, Mr. Childer's motion in House of Commons against financial method of naval proposals rejected.—April 4.  
 England, Naval Manoeuvres, official report of Committee to British Admiralty issued.—April 8.  
 Germany, Corvette "Sophie" starts from Zanzibar for Samoa.—April 5.  
 German cruiser "Habicht" and the gunboat "Wolf" to be put in readiness to proceed to Samoa.—April 4.  
 Germany cruiser "Spartan" and corvette "Alexandrine" ordered to Samoa.—April 1.

## NAVAL—Continued.

Germany, Samoa disaster referred to, by Naval Secretary in Reichstag.—April 3.  
 Germany, loss in Samoa, Imperial order issued in relation to the loss of officers and men.—April 4.  
 Germany, Bismarck issues order in which he defines the responsibilities of commanders of warships with respect to requests of consula abroad.—April 18.  
 German, "Olga" stranded at Samoa, arrives at Sydney, N. S. W., for purpose of repairing damages.—April 15.  
 Government of New Zealand places steamship "Hibernia" at disposal of Admiral Kimberly.—April 2.  
 Russia, Vice-Admiral Tchikatcheff submits to Czar report on condition of.—April 9.  
 Samoan disaster, news of, brought to San Francisco by steamship "Alameda."—April 13.  
 United States, oavy pay office at San Francisco ordered by Washington authorities to forward to Samoa by steamer "Zealandia" all mail addressed to naval officers at Samoa.—April 3.  
 United States, committee appointed to recommend suitable site for oavy yard on Pacific Coast select site on Puget Sound, W. T.—April 6.  
 United States, death of Rear Admiral W. R. Taylor, at Washington.—April 14.  
 United States, non arrival of Samoa at Monongahela, causing measures at Washington.—April 22.  
 United States, disaster at Samoa, Secretary Tracey's letter to Admiral Kimberly.—April 27.  
 New Brunswick Legislature, bill passed to incorporate a company to build railway from Harvey to Salisbury.—April 10.  
 New Brunswick Legislature, St. John and Portland bill for union of, introduced into Legislature.—April 11.  
 Newfoundland Legislature, Manhood suffrage bill passes its third reading in House of Assembly.—April 13.  
 New South Wales Assembly decides in favor of fixed salary to members.—April 10.  
 New South Wales Government proposes to abolish all specific duties and to impose direct taxation in their stead.—April 10.  
 New South Wales, Rabbits, Sydney Committee reports on, discovery of M. Pasteur to exterminate rabbits.—April 10.  
 New York State Assembly, The Caxton Ballot Reform Bill passed.—April 9.  
 New York assembly, excise commision bill passe by.—April 3.  
 Nihilist, Vitna Russia, arrest of.—April 2.  
 Nihilist, Zurich, 13 more arrests made, three prisoners escape.—April 2.  
 Nihilism, Meyer arrested at Constantinople and sent to St. Petersburg.—April 14.  
 Nihilism, Zurich, Russian lady employed as a governess in family residence arrested and charged with Nihilism.—April 15.  
 Norfolk, Va., Cyclone doing large amount of damage.—April 6.  
 Oatmeal Millers Association of Ontario disbanded.—April 18.  
 Oil, Andover, N. Y., rich strikes made.—April 8.  
 Oklahoma, Amarron River rising and doing much damage.—April 12.  
 Oklahoma, conflict between boomers-entailmen and Chickasaw police at the ford at Chisholm, several killed.—April 17.  
 Oklahoma, Fitzpatrick Prof. F. A., returns to Kansas City, and states not more than one third of territory tillable.—April 18.  
 Oklahoma, B. R. Groom, land owner in Northern Texas, says one-fifth of land in newly opened territory is good.—April 23.  
 Opium smuggled, San Francisco, heavy seizure made.—April 22.  
 Oregon Improvement Company declares dividend.—April 18.  
 Ouseley, Rev. Sir Frederick Arthur Gore, professor of music, death of, in England.—April 8.  
 PANAMA.—Canal Works, distressed condition of negroes, British Consul distributes bread among sufferers.—April 9.  
 Lottery drawing takes place in Paris.—April 15.  
 Liquidators inform shareholders re-issue of unsold lottery bonds would realize 12,500,000 francs.—April 15.  
 Civil Tribunal at Paris orders liquidation to compensate discharged employes.—April 19.  
 Paris, Tex., riot at City Council, Mayor and Ald. Allen summoned and fined.—April 9.  
 Parnell Mr., Edinburgh, three meetings protest against conferring freedom of city upon.—April 22.  
 Parnell Mr. C. S., Edinburgh town council agree to confer freedom of the city on.—April 23.



**PARNELL TIMES**, commission, Sir Charles Russell opens case for the Parnellites.—April 2.

Commission, Sir Charles Russell continues his speech.—April 11.

Commission, Sir Charles Russell concludes his speech.—April 12.

Commission, Molloy Patrick T., witness for Times, convicted of perjury at London, Eng.—April 15.

Commission, Mr. Parnell begins giving evidence.—April 30.

Libel action, statement of claim for £100,000 delivered.—April 16.

Parnell Mr. C. S., elected honorary life member of National Liberal club.—April 3.

Paucetto e Sir Julian, British Minister to Washington, arrives at New York.—April 21.

Pearl fisheries, Western India, dispatch announces failure of, owing to prevalence of cholera.—April 9.

Pennsylvania, Industries of, address by Mr. Andrew Carnegie, at Harrisburg, Pa.—April 9.

Persian Government cedes Russia the districts of Kelat and Kadira.—April 9.

Persia cedes to Russia the frontiers at Kalatanadir.—April 15.

Petroleum discovered at Kingsville, Ont.—April 6.

Petroleum, Pittsburg, Pa., has another bear raid, values broke nearly three cents in two hours.—April 22.

Philadelphia, explosion of gas in new sewer, streets torn up.—April 2.

Pilgrims American Catholic, reach Jaffa from Iamailia.—April 7.

Pittsburg, Pa., big landslide on second avenue.—April 2.

Plater Count, dies at Kitchburg.—April 24.

Pope the, and the English speech of Cardinal Lavigerie at charity meeting in Algiers Cathedral, dispatch to *London Times* from Paris.—April 17.

Pope Hon. J. H., death of, at Ottawa.—April 1.

Prince Edward County, shortage found in Treasurer's books, new treasurer selected.—April 9.

Prussia, Bohnsack, several buildings fall into river Vistula and occupants drowned.—April 6.

Rabbits, New South Wales, Sydney committee reports on discovery of M. Pasteur to exterminate rabbits.—April 19.

**RAILWAYS**, Chicago and Atlantic, chairman of Interstate Commerce Commission rules that a road has no authority for making a higher rate over a connecting line than the one actually made by that line.—April 5.

Africa, British Central African Company established in London.—April 11.

Canadian Pacific make connection with Michigan Central Road.—April 22.

Canadian Pacific, reduction of rates on hardware and grocers' supplies between Montreal and London, Ont.—April 26.

Cape Breton road discussed in Canadian House of Commons.—April 11.

Chicago, Hudson and Delaware, Grand Jury find two additional indictments against Ives Stayner and Woodruff for over-issue of 7,100 shares of stock.—April 5.

Claim of Pennsylvania railway against Philadelphia and Erie Co. for \$650,000, and against North Central for a like amount, on account of joint guarantee of the Alleghany Valley railroad decided by Judge Arnold against Pennsylvania Company.—April 6.

Collector of customs at Niagara Suspension Bridge recommends U. S. District Attorney to prosecute Michigan Central, Grand Trunk and West Shore railways for violation of Alien color law.—April 6.

Freight difficulties, Hickson Mr. Joseph, manager of Grand Trunk, gives his views on, to reporter of *New York Times*.—April 11.

General passenger agents of trunk lines at New York recommend appointment of Lucius Tuttle as chairman of Passenger Committee.—April 10.

Grand Trunk Railway, Interstate Commerce Commission begins hearing case against, at Washington.—April 4.

Grand Trunk, meeting at London, Eng., statement by Sir Henry Tyler.—April 16.

Grand Trunk Railway, Interstate Commerce Commission decides that must obey law's provisions.—April 20.

Harvey to Salisbury, U. S. bill passed to incorporate a company to build Railway.—April 10.

Iron Mountain Railway gives notice Sunday train service after 1 May will be discontinued.—April 27.

Jamaica, sale of entire railway system in island by Colonial Government to American syndicate.—April 3.

Japan Railway Co. receives permission from President of State to double line between Meas and Omya.—April 5.

Morrisburg and New York railway, incorporation bill thrown out in Canadian Senate.—April 2.

#### RAILWAYS—Continued.

New Brunswick Grand Southern Railway transferred to employees of Russell Sage's Company.—April 9.

New York, Ontario and Western Railroad, special meeting of, authorizes issue of \$10,000,000 new 5 per cent. bonds.—April 3.

Northern Pacific sells large block of Manitoba and N.P. Bonds in New York.—April 24.

Report for half year issued in London.—April 5.

Sebastopol railway, Russian Government decides to extend to Theodosia, and make commercial port of latter place.—April 9.

Union Pacific, annual report for 1888 issued.—April 22.

Vaudreuil and Prescott Company, Hawkesbury, votes bonus of \$4,000, and Clarence bonus of \$8,000.—April 4.

Winnipeg and Hudson Bay, Manitoba's guarantee of Bonds to question asked in British House of Commons.—April 4.

Rat Portage, Board of Trade organized.—April 5.

Rideau canal opens.—April 22.

Rosa Carl, musical director, death of, at Paris, France.—April 30.

Roumania, Anti-Russian procedure of Cabinet, Russian Minister at Bucharest instructed to demand explanations.—April 1.

Royal Geographical Society, London, Eng., meeting of, letter from Stanley read at.—April 6.

**RUSSIA**, Moscow, Merchants of, petition the government to forbid importation of foreign foods, by way of Petchora, Obe Zemee, and Lena Rivers.—April 5.

Achinoff expedition, St. Petersburg official messenger publishes statement made by traders of expedition as to bombardment of Sagalo.—April 14.

Artillery officers arrested for plotting against Czar.—April 22.

Achinoff Palace, revolutionary pamphlets found upon Czar's table a number of servants arrested.—April 27.

Baltic provinces, persecution of Germans in.—April 27.

Bucharest, rumoured attempt made upon the life of Czar.—April 11.

Council of Empire recommends abandonment of prosecution on those held responsible for accident to Imperial train near Berke.—April 24.

Four officers wager they can ride on horseback from St. Petersburg to Paris in 45 days.—April 9.

Navy, vice-admiral Tchikatcheff submits to Czar report on condition of.—April 19.

Nihilist plot discovered by Prefect of Police of St. Petersburg, to assassinate Czar, while attending funeral of General Pauker, number of persons arrested.—April 19.

The frontiers at Kalatanadir ceded by Persia.—April 15.

Nihilist Meyer arrested at Constantinople and sent to St. Petersburg.—April 14.

Pontilian, head of department of secret police, and several high officers dismissed.—April 29.

Sebastopol railway, Government decides to extend to Theodosia, and make commercial port of latter place.—April 9.

Yilna, arrest of Nihilists at.—April 2.

Zurich, manufacture of bombs at, newspapers prohibited from publishing reports of.—April 1.

Sagalo, bombardment of Russia demands 45,000 roubles of France.—April 22.

St Louis gas trust, Standard Oil Company buys.—April 23.

St. John and Portland, N. B., bill for union of, introduced into local legislature.—April 11.

St. Paul, Minn., warrants issued for arrest of 13 persons charged with bribery and corruption in connection with legislative measures.—April 18.

Salisbury Lord, speaks at Bristol, and defends the course pursued by his Government.—April 23.

Salt, Kingston, Ont., seizure of 100 barrels by inspector of weights and measures.—April 27.

**SAMOA**, German naval secretary in Reichstag, refers to loss of warships and as to the general situation.—April 3.

Agreement reached by U. S. State department and German Foreign office, that there shall be no reinforcement of vessels or troops belonging to both governments on duty at Samoa.—April 9.

Authoritative statement made at Washington that three treaty powers England, Germany and United States, agree to keep but one war vessel at Samoa pending Berlin conference.—April 10.

Conference, statement for, prepared by Count Herbert Bismarck, and approved by Sir Edward Maitel.—April 20.

Conference concerning, opens in Congress hall of Prince Bismarck's residence.—April 19.

German naval authorities order cruiser "Habitat" and gunboat "Wolf" to proceed to Samoa.—April 4.

SAMOA  
Ger  
5.  
Ger  
K  
Gov  
of  
Mali  
m  
Navy  
to  
na  
Saskatch  
Po  
Schellha  
cit  
Scotland  
lu  
Scottish  
Ap  
Scott Act  
in  
Serrin, C  
wo  
Serrin, G  
000  
Serrin, M  
SHIPPING  
all  
"Car"  
"N"  
Danish  
line  
"Dan"  
"M"  
"Dan"  
on a  
"Dan"  
Murrel  
Dan  
and  
Ewig  
Mail at  
—Ap  
Newpo  
ashor  
Norfol  
vess  
Queen  
Schon  
Sea"  
ashor  
from  
W. C  
Sloop  
April  
South I  
tong  
at Al  
Spain, I  
—Ap  
Steam  
deser  
Steamer  
drown  
Toronto  
quire  
April  
Wrecks  
"Wre  
Sik cultur  
Smallpox,  
Smallpox, N  
ity e  
Smith A. J.,

## SAMOA.—Continued.

German Corvette "Sophie" starts from Zanzibar for Samoa.—April 5.

Germany, White book issued, in which Bismarck censures Consul Knapp's conduct.—April 19.

Government of New Zealand places steamship "Hinemoa" at disposal of Admiral Kimberley.—April 2.

Malletta deposed, King apologizes, and Emperor William declares he may be liberated.—April 30.

Naval disaster, news brought to San Francisco by steamship "Alameda".—April 13.

Navy pay office at San Francisco ordered by Washington authorities to forward to Samoa, by steamer "Zealandia," all mail addressed to naval officers at Samoa.—April 3.

Faskatchewan Institute, Perry A. B., superintendent of N. W. Mounted Police, appointed president of.—April 2.

Schellha Baron Von, at New York, secur-s his papers as an American citizen.—April 2.

Scotland local government, bill providing for, introduced by Lord Advocate in British House of Commons.—April 8.

Scottish home rule, motion for, in British House of Commons rejected.—April 9.

Scott Act repealed by 12 counties and 2 cities in Ontario, and one county in Nova Scotia.—April 4.

Serbia, Chamber of Deputies, Minister of War asks for \$3,000,000 to continue work on fortifications round the city.—April 1.

Serbia, Government decides to fortify town of Serajevo at cost of \$2,000,000.—April 23.

Servia, Milan ex King, becomes a monk of Jerusalem.—April 22.

SHIPPING.—Indian schooner, which left Port Angeles, lost in gale with all hands.—April 1.

"Garrie Doyle" British schooner sunk in collision with steamer "Noordland".—April 7.

Danish Steamer "Danmark" abandoned by her crew passed by Inman line steamer "City of Chester".—April 8.

"Danmark" steamship, 42 of the crew arrive at Lisbon on steamer "Missouri".—April 21.

"Danmark" steamship, 331 people from wreck arrive at Philadelphia on steamship "Missouri".—April 22.

"Danmark" Captain and engineers officially certify as to condition of engines.—April 27.

Murrell, captain of steamer "Missouri," appointed Knight of order of Danebrog by King Christian of Denmark, for rescuing passengers and crew of "Danmark".—April 27.

Emigrants on Steamer "Noordland," which collided off Beachy Head and put into Southampton for repairs, forbidden to land.—April 8.

Mail steamer "Princess Josephine" in collision with unknown barque.—April 6.

Newport, R. I., steamer "Consistent" running to Jamestown runs ashore on rocks.—April 12.

Norfolk, Va., unknown vessel goes ashore, all on board drowned, and vessel goes to pieces.—April 17.

Queenstown, new steamer "City of Paris" arrives at.—April 24.

Schooner "B. F. Poole" from Providence to Baltimore ashore near Sea Tack Station, Pa. Schooner "Emma F. Hart" of Boston, ashore south of Cape Henry light. Schooner "Andrew Johnson" from Baltimore to Rio aground near York River. Schooner "G. W. Covington" capsized to Hampton roads.—April 7.

Sloop "Revenus" of Athens, N. Y., sunk by steamer "Drew".—April 11.

South Pacific, wrecks reported American ship "Red Cross" at Bara-tonga, American ship "Ada Owen" at Onara, British ship "Sunken" at Aitutaki, reported.—April 2.

Spain, heavy gales reported off coast, and several wrecks reported.—April 11.

Steamer "Danmark" sighted by "City of Chester" in the Atlantic deserted.—April 13.

Steamer "Everett" sunk at head of Otter Inland, and five persons drowned.—April 18.

Toronto, Hamilton, and Montreal capitalists form company and acquire steamers to ply between Montreal, Toronto and Chicago.—April 1.

Wrecks on Lower Chesapeake and Potomac caused by storm, see "Wrecks".—April 8.

Silk culturist, state convention of, held at Wichita, Ka.—April 11.

Small pox, Nanticoke, Pa., smallpox spreading in.—April 10.

Smallpox, Nanticoke, Pa., Arthur Evans stricken with disease, great anx- iety exists.—April 17.

Smith A. J., secretary of defunct Winnipeg Call, death of.—April 19.

Smith Rt. Hon. W. H., government leader in British House of Commons banquet given to, in London, England, by merchants and bankers.—April 10.

Smuggling, Hawaii, bark "O. D. Bryant" seized by government at Honolulu for smuggling opium.—March 23rd, reported April 13.

Smuggling, New York, extensive scheme carried on by Allard & Sons of Paris and No. 304 Fifth Avenue, unearthed by special Treasury Agent Simmons.—April 5.

Smuggling Opium, San Francisco, heavy seizure made.—April 22.

Snails, shower of, at Tiffin, Ohio.—April 19.

Snow storm, Staunton, Va., severest storm for thirty years.—April 8.

Socialism, Germany, Berlin Courts decide that all the recent dispersals of Socialist meeting by the police were illegal.—April 5.

Socialism, Italy, Deputy Costa sentenced to imprisonment for being concerned in recent street riots.—April 5.

SPAIN and China, government refuses China's request for permission to establish consulates in Manila and at other points in the Pacific.—April 9.

Valencia, dynamite petard exploded in a church.—April 19.

SPORTS, baseball, New York, Teams arrive home from England.—April 6.

Aquatics, International Yacht race, Lord Dunsraven agrees to sail his new yacht for cup.—April 12.

Aquatics, Sydney, N.S.W., Searle, oarsman, deposits forfeit for matches with Teemer and O'Connor for championship of world.—April 24.

Jumping, Meredith Stanley jumps from Cincinnati Southern railway bridge over Kentucky river.—April 11.

Lacrosse, Council of National Amateur Lacrosse Association meets at Montreal.—April 12.

Lacrosse, Ottawa Club, annual meeting of.—April 3.

Lacrosse, Toronto Club, annual meeting of.—April 3.

Racing, Leicester, Eng., Excelsior Breeders foal stakes won by Bay Billy "Bena".—April 5.

Racing, Northamptonshire stakes won by Lord Howes "Claymore".—April 3.

Race-go-as-you-please, Pittsburg, Pa., close of.—April 13.

Racing, City and suburban handicap run to day.—April 24.

Racing, San Francisco, Pacific Derby "Czar" wins.—April 23.

Riding, four officers wager they can ride on horseback from St. Petersburg to Paris in 45 days.—April 9.

Ring, Prize fight between Reddy Henesay of Brooklyn, N. Y., and Jack Gallagher of Fort Worth, Texas.—April 6.

The ring, Woodford County, Attorney General Hunt writes State Attorney Kennedy of Woodford County, calling attention to press reports of prize fight, and urges speedy steps for indictment of all concerned.—April 8.

Yachting, annual meeting of St. Lawrence Yacht Club, Montreal.—April 6.

Yachting, Queen presents cup to Royal Cork Yacht Club to be com- pleted for, at Queenstown.—April 24.

STANLEY H. M.—Arabs arrive at Stanley Falls, and report Stanley and Emin Pasha heard from in February, as marching on Zanzibar, advices received at Brussels.—April 4.

Royal Geographical Society receives letter from.—April 5.

Sir Francis De Winton, president of Emin Bey Relief Committee, doubts truth of story brought to Stanley Falls by Arabs.—April 5.

Letter from, read at meeting of Royal Geographical Society in Lon- don, Eng.—April 8.

Despatch to Brussels from Zanzibar says rumour that Stanley marching on Zanzibar is an Arab invention.—April 9.

Positive information received by British Foreign Office that Stanley had second meeting with Emin Pasha and delect army of Khalifa.—April 23.

Stanley Meredith, jumps from Cincinnati Southern railway bridge over Kentucky river.—April 11.

Stanstead, Que., Malvern Mr. J. S., accidentally shot and dies from effect.—April 3.

Staunton, Va., severest snowstorm prevails known for thirty years.—April 6.

STRIKES.—Carpenters, St. Louis, go out.—April 1.

Alleghany, Bessemer Steel Works at Duquesne, Pa., eighteen colored non-union men arrive, and are compelled to return home.—April 23.

Carmen, Vienna.—April 21.

Dock workers, Marseilles, 1,000 strike, suspension of work general.—April 1.

Farmers, New York, work resumed at terms demanded.—April 3.

Joiners, Nurnberg, serious riot as result of lookout declared by master joiners against striking employees.—April 8.

Dock workers, Marseilles, authorities place guards at the offices.—April 11.

Miners, Monongahela river miners in four pools, excepting those em- ployed by Homer and Roberts, resume work.—April 8.

## STRIKES.—Continued.

Street railways, London labor agitators urging English car drivers to formulate demands upon their employers, and organize general strike to enforce them.—April 30.

Street car, Minneapolis, conductors and engineers on Motor line strike.—April 11.

Minneapolis, Street Car Co. states it will move cars when Mayor can furnish adequate police protection.—April 18.

Minneapolis, Street car, serious riots take place.—April 21.

Street cars, Minneapolis, tracks torn up and other work of destruction carried on.—April 21.

Street Car Company, St. Paul men at work on cable line on East Seventh street strike for advance in wages.—April 29.

New York, painters and farmers go out.—April 1.

Rochester, street car, conflicts between strikers and police.—April 8.

Tramway, Edinburgh, men make demands and threaten strike.—April 24.

Sugar convention bill introduced into British House of Commons by Baron Henry de Worms.—April 11.

Sugar, Vienna, rise of price.—April 18.

Sugar, Clyde market, excited sale in.—April 18.

Sunderland, Eng., platform gives way during laying of corner stone of reformatory by Marquis of Hartington.—April 17.

SUICIDE.—London, Eng., Rev. Charles Sydney Hurd, lately of Palmerston Unitarian Chapel, Boston, kills himself by taking opium.—April 1.

Attempted, Brooklyn bridge. Patrick Carroll, shoemaker, jumps into East river.—April 23.

Easton, Va., Jacob Sanot, eminent commander of the Hugh de Payne Commandery Knight Templars, hangs himself.—April 8.

France, Henri Rochefort's son commits suicide at Bona.—April 27.

Quebec, Creighton Mr., manager of Bank of Montreal.—April 13.

Vienna, Countess Josephine Radetzky shoots herself.—April 1.

Williams George, steerage passenger on steamer "Sarnia," jumps overboard.—April 11.

Sweden, Crown Princess gives birth to third son.—April 20.

Sweden, Princess Eugenia, sister of King, death of.—April 23.

Sweden, Rufus Magee, U. S. minister, reports effect of tariff laws on price of food.—April 23.

Switzerland, sharp shocks of earthquake at.—April 30.

Melbourne, Bijou theatre burned.—April 22.

Tea, Yokohama, first consignment of new tea arrives at.—April 5.

Telegraphs, France and China agree to connect China and Tongkin telegraph lines, and thus establish communication between Saigou and Peking.—April 11.

Telegraph, New York, injunction procured by Western Union Telegraph Co., against Mayor and Board of Electrical control of New York, vacated by Court.—April 12.

New York, poles cut down by order of Mayor.—April 16.

Telephones, American Bell Telephone Co., John E. Hudson elected president.—April 2.

Telephones, England, proposal to consolidate three leading telephone companies into one organization.—April 8.

Tennessee Legislature, Doritch election bill passed by.—April 3.

THEATRICAL.—Anderson Mary, leaves New York for England.—April 2.

Barnes Anglo-American troupe receives verdict against Mr. Ledger, proprietor of the *Fra*, for £300.—April 8.

Paris, French version of Phillips' "As in Looking Glass," under title of "Leua," produced by Sarah Bernhardt, at Variety Theatre.—April 17.

Rochester, Edwin Booth taken seriously ill while playing "Othello," at Lyceum theatre.—April 3.

Tiffin, Ohio, shower of snails at.—April 19.

Toronto, block paving contractors suspend work. 800 men thrown out of work.—April 18.

Toronto, Queen's University, conferment of degree on Rev. E. E. Jenkins.—April 24.

Trade and commerce, United Kingdom Consul General Waller reports revival of.—April 23.

Train George Francis, fasting of, at New York.—April 24.

St. Louis gas, Standard Oil Company buys.—April 23.

TRUSTS.—Coke, Pennsylvania, movement on foot to form trust.—April 4.

Dublin, Jamieson's refuse to join.—April 5.

Sugar, New York, all companies in trust assign to three individuals to dodge the law.—April 15.

Sugar refineries, big jump in stock at New York on report that C. A. Spreckles, sugar king, had been won over by trust.—April 11.

Whiskey, Dublin, formation of.—April 3.

## TRUSTS.—Continued.

Whiskey, George W. Kidd, of New York, wholesale liquor dealer, goes in to break the trust.—April 18.

Mr. Clarke Wallace's bill as to, before committee of Canadian House of Commons.—April 12.

UNITED STATES CONGRESS.—Senate, Bright late Mr. John, resolutions passed expressing sorrow at death of.—April 1.

Senate, nominations sent by President to Huston to be Treasurer of U. S.—Robert, Assistant Treasurer at New York; Warton, Assistant Secretary of State; Shields, Assistant Attorney-General; Bradford, Governor of New Mexico.—April 1.

Usher John P., Secretary of Interior under President Lincoln, death of at University hospital at Philadelphia.—April 13.

Vaccination, Commission appointed in British House of Commons to enquire into Vaccination Act.—April 5.

Venezuela, nephew of Guzman Blanco, ex-president, arrested for forgery while trying to escape to United States.—April 5.

Wagener Frederik William Hermann, German statesman, death of.—April 23.

Waller Consul General, of London, Eng., reports general revival of trade and commerce in United Kingdom.—April 23.

Washington Centennial celebration, United States.—April 29-30.

Welland canal opens for navigation.—April 18.

White Cops, Indianapolis, Warwick and Dubois counties, encounter with John Lansford, supervisor of Madison Township, W. T. Mastersson of Newburgh hanged.—April 11.

Whitesaps, Milton, Ont., John Hame, alleged to be one of Georgetown Whitesaps, committed for trial.—April 8.

Winipeg, Everett Hon. A. W., Count de Sainville and T. Young, leave on trip of exploration to Arctic seas.—April 15.

Woman's Suffrage. Goldwin Smith writes *Times* thereon.—April 10.

WRECKS.—Argyle race rocks, Indian schooner which left Port Angeles lost with crew.—April 1.

"Carrie Dingle," British schooner, sunk in collision with steamer "Noordland."—April 7.

Carter's creek, schooner "Columbia F. O." sunk.—April 8.

Chesapeake, schooner "Carolina" broken up on Cove Point Bar.

Schooner "W. P. Snow," for Baltimore from Patuxent wrecked near Milestone Creek. Two unknown vessels ashore in Bayle Creek.—April 8.

Coan river, schooner "William Coburn" and sloop "Amelia Cowart" ashore.—April 8.

Danish steamer "Danmark" abandoned by her crew, passed by Inman line steamer "City of Chester."—April 8.

"Danmark" steamship, 42 of the crew arrive at Lisbon on steamer "Missouri."—April 21.

"Danmark" steamship, 381 people from wreck arrive at Philadelphia on steamer "Missouri."—April 23.

Hooper's Island, Chesapeake. Two sloops ashore on Eastern side.—April 7.

James River, Captain Elijah Benson and his two sons of Portsmouth, capsized in oyster sloop, and drowned.—April 8.

Newport, R. I., steamer "Cowanicut" running to Jamestown near ashore on rocks.—April 12.

Norfolk, Va., unknown vessel goes ashore, all on board drowned and vessel goes to pieces.—April 17.

Onancock Creek, steamer "Helen" of Eastern Shore Steamboat Company ashore.—April 7.

Schooner "B. F. Poop" from Providence to Baltimore ashore near Sea Tack Station, Pa. Schooner "Emma P. Hart" of Boston ashore south of Cape Henry light. Schooner "Andrew Johnson" from Baltimore to Rio around near York River. Schooner "G. W. Covington" capsized in Hampton roads.—April 7.

Scott's Creek. Thirty vessels ashore.—April 8.

Sloop "Revenue" of Athens, N. Y., sunk by steamer "Drew."—April 11.

Smith's Island, Chesapeake. Eleven boats ashore.—April 7.

South Pacific American ship "Red Cross" at Rarounga, American ship "Ada Owen" at Onara, British ship "Suakim" at Alutaki.—Reported April 2.

Spain, heavy gales off coast, and several wrecks reported.—April 11.

Yocombo River, vessels ashore, sloop "Addie," punga "Humming Bird," sloops "Lillie Dale" and "Dove," punga "George," schooners "Martha Washington" and "Thomas J. Parks."—April 8.

Yellow fever, Sanford, Fla., case appears at.—April 22.

Yellow fever, Santos and Rio Janeiro, raging at, British steamship "Pine Branch" at Baltimore from Rio Janeiro reports.—April 23.

York, London, stone contractor, drops dead in Toronto.—April 13.

WHO SUBSCRIBE TO THE

## "INDEX OF CURRENT EVENTS."

The "Index of Current Events" is much appreciated not only by the press of Canada and the United States, but also by the public men of both countries. Its list of subscribers includes such great newspapers as the Philadelphia *Ledger*, the Boston *Transcript*, the New York *World*, the Cincinnati *Enquirer*, the Brooklyn *Eagle*, the Toronto *Empire*, the Cleveland *Leader*, the Chicago *Herald*, the Cincinnati *Post*, the New York *Morning Journal*, the Chicago *Daily News*, the Indianapolis *Journal*, the New York *Star*, the Troy *Budget*, the Chicago *Staats Zeitung*, the New York *Nation*, the Troy *Press*, the Washington *Star*, the Chicago *Inter-Ocean*, and many less known but important newspapers. Some of these papers are well known to keep admirable indexes of their own, yet find it advantageous to subscribe to the INDEX OF CURRENT EVENTS. We have the honor to include among our subscribers, Her Majesty's Privy Council for Canada; also, Sir John Macdonald, G. C. B., Premier of the Dominion, Sir Hector Langevin, Minister of Public Works, Sir A. P. Caron, Minister of Militia, the Hon. G. E. Foster, Minister of Finance, the Hon. Mackenzie Bowell, Minister of Customs, the Hon. J. A. Chapleau, Secretary of State, the Hon. John Costigan, Minister of Inland Revenue, the Hon. John Haggart, Postmaster General, the Hon. John Carling, Minister of Agriculture, the Hon. C. H. Tupper, Minister of Marine and Fisheries, the Hon. Commissioner of Agriculture and Colonization Quebec, the Hon. Boucher de La Bruère, late speaker of the Legislative Council, Quebec, the Hon. Lieutenant Governor Royal. Mr. Erastus Wiman, the Hon. Minister of Public Works, Toronto. The Librarian of Parliament, the House of Commons Reading Room and the Librarians of many of the Provinces of the Dominion and States of the Union subscribe to the *Index*. Among the well known public librarians who subscribe are, Mr. J. C. Hurlbut, Librarian of the American Geographical Society, New-York, Mr. W. A. Bordwell, Librarian of the Brooklyn Library, Mr. W. H. Brett, Librarian of the Cleveland Public Library, Mr. F. P. Jordan, Librarian of the Public School Library, Battle Creek, Michigan, Mr. W. T. Peoples, Librarian of the Mercantile Library, New-York, Mr. Robert E. Rich, Librarian of the Public Library, Portsmouth, N.

H., Mr. J. P. Dunn, Librarian of the Indiana State Library, Indianapolis, Mr. F. W. Vaughan, Librarian of the Social Law Library, Boston, the Librarian of the Philadelphia Library, Mr. John M. Doane, State Librarian of Ohio and Mr. William H. Eagle, State Librarian of Pennsylvania. The leading bankers (including the Bank of Montreal), brokers, lawyers and hotel keepers of Canada, and many clergymen also keep the *Index* on file.

What is thought of the *Index* may be gathered from the numerous entirely unsolicited expressions of approval sent in by well known public men, of which the following are specimens:

MR. MARTIN J. GRIFFIN, LIBRARIAN OF PARLIAMENT, Ottawa, writes I am sending you a subscription for two copies of your "*Index*," which will be most useful and which deserves encouragement. If you will take particular pains to give the dates and figures of elections and the dates of speeches of public men, with reference also to the place at which the speech was delivered, you will do a very grateful thing for public people and editors, and I may add librarians.

MR. JOHN M. DOANE, STATE LIBRARIAN OF OHIO, writes:—Enclosed please find six dollars, in payment for State Library subscription to the "*Index of Current Events*" for 1889.

I regard it as a very valuable publication, and hope that you may meet with such success as to warrant its continuance, or it will grow more valuable every year.

MR. HERRICK, OF THE BROOKLYN *Eagle*, writes:—"I congratulate you most heartily upon having done a good thing, a very good thing, in starting the "*Index*" enterprise. I hope I may have the joy of congratulating you upon your success a year hence. A man with *Index* on the brain is one after my own heart. My judgment was formed upon Number I; if the *Index* is kept up as thoroughly in all subsequent numbers it will be a great help to us."

SIR CHARLES TUPPER, BART., HIGH COMMISSIONER FOR CANADA, writes:—"It seems to me to be a very useful publication, and one that will be valuable for reference purposes."

MR. BUSH, ASSOCIATE EDITOR OF THE PHILADELPHIA *Public Ledger*, writes:—"Your *Index* is highly appreciated at this office, where it has long been a desideratum."

MR. COLQUHOUN OF THE "TORONTO EMPIRE," writes:—"Allow me to congratulate you most cordially upon your admirable *Index*. The idea and its execution are alike worthy of all praise."

MR. VADEN, OF THE "NEW-YORK MORNING JOURNAL," writes:—"I find the *Indices* of great value, saving, as they do, much valuable time in looking up important events."

MR. WILL A. WOODWARD, REC. SEC. MASS. PRESS ASSOCIATION, writes:—"Enclosed please find subscription for one year for "*Index of Current Events*." I have examined the specimen sent me with much interest and do not hesitate to commend it as an invaluable assistant in the newspaper office. The amount of time and labor it is calculated to save, cannot be compensated by one hundred times its subscription rate.

Commencing with Vol. II No. I the dates given in the *Index* are the actual dates of the occurrences; not as formerly the dates of publication.

The *Index* is published four times a month; but to form a complete file for the year it is necessary to preserve only the first issue in each month.

The intermediate issues contain the news of the current month to date.

The subscription is \$6 per annum, payable yearly or half yearly in advance. Remittances should be made to

HENRY DALBY,

P. O. Box 864,

MONTREAL, Que.



# THE INDEX OF CURRENT EVENTS.

VOL. II. No. 20.

MONTREAL, JUNE 6, 1889.

\$3.00 PER ANNUM.  
PUBLISHED WEEKLY.

## MAY

Abyssinia, advices from Massowah give details concerning recent death of King John.—May 3.

Abyssinia, Premier Oriapi in Italian chamber of deputies says as soon as treaty of peace signed, government proposed to give Massowah a civil administration.—May 8.

Abyssinia, Count Antonicelli, leader of Italian mission to King of Shoa telegraphs to Rome accounts of recent fight between Abyssinians and Derwishes.—May 10.

Alberta Exploration Company registered in England with capital of £20,000.—May 15.

**ACCIDENTS, drowning, Buckingham, Que., Rev. Mr. Evans, drowned by upsetting of a canoe.—May 9.**

Aeronaut, St. Clair Prof., at Fair, Ground Park, Houston, Tex., fall 300 feet to earth.—May 12.

Cyclone, Clements, west of Emporia, Ka., Captain Brown and daughter killed and wife and son injured.—May 27.

Cyclone, McPherson, Kansas, several lives lost and houses demolished.—May 29.

Drowning, Amherstburg, Ont., Cunningham Major J. R., drowned while crossing Roblin Lake.—May 18.

Drowning, Batesville, Ark., two Baptist ministers, John and James R. Moxley, drowned.—May 25.

Drowning, Chambord, Que., Pierre Morin of St. Jérôme and boy drowned in Metabetchouan harbor.—May 10.

Drowning, Lake Front, Fla., W. T. Denham, son of, and Miss Sheretz.—May 16.

Drowning, St. Anne's, P.Q., two young men from Hull named Gervais and Pelletier drowned while wading a barge.—May 15.

Drowning, St. Andrews, N.B., sinking of sloop off Hardwood Island, six men drowned.—May 4.

Drowning, Vicksburg, Miss., nine negroes drowned by upsetting of skiff.—May 19.

Explosions, Havana, Cuba, a woman, two daughters and colored boy burned to death.—May 26.

Explosion, Pittsburg at Torus, new mines of the Chartier's Coal Company, four Hungarians killed.—May 12.

Explosions, Wales, Ont., boiler of engine on Grand Trunk Railway explodes seriously injuring man named Macintosh and others.—May 25.

Fall of wall, New York, two men killed by fall of wall at 151 Spring Street.—May 13.

Fire-arms, Salcoats, Man., John Patton kills his nephew accidentally with a gun.—May 14.

Fires, Abingdon, Balmoral, Mr. William's house burned, four children burned to death.—May 2.

Fires, Aylmer, Ont., pork packing establishment of Walker & Marlett.—May 12.

Fires, Danville, Vt., twenty-three buildings destroyed, loss \$50,000.—May 10.

Fires, Edinburg, Vt., barn set fire to by a boy Charles Parouta, who is burned to death.—May 27.

Fires, forest, Belleville, Ont., much damage done by.—May 14.

Fires, forest, Minnesota and Northern Wisconsin, immense amount of damage done.—May 4.

Fires, forest, Northern Wisconsin, fires raging, many towns surrounded.—May 10.

Fires, Galicia, Podhajee, 600 houses, a church and synagogue destroyed, 12 corpses recovered.—May 28.

Fires, Hamburg, American steamer "Rugia" from New York, cargo of cotton takes fire.—May 8.

Fires, Havelock Corners, Kings County, settlement destroyed.—May 26.

Fires, Hillham, Ind., Wisemann Mrs. C., house destroyed, two children burned to death.—May 6.

Fires, Japan, Yokoto, 1000 houses destroyed.—May 3, reported May 28.

Fires, Jersey City, Academy of Music takes fire.—May 14.

## ACCIDENTS.—Continued.

Fires, Liverpool, Steamer "England" from New Orleans arrives with cargo of cotton on fire.—May 22.

Fires, Liverpool, steamer "Servia" arrives at, with cargo on fire.—May 24.

Fires, Montreal, Warlen King & Son's Foundry partially destroyed.—May 7.

Fires, "Parkhurst" London steamer, arrives at Rio de Janeiro with cargo on fire. News brought to Queenstown by Inman liner "City of New York."—May 29.

Fires, Quebec, store on Allan's steamship wharf destroyed.—May 27.

Fire, Queenstown, Spanish steamer "Emillanos" arrives, with cotton in fore and main holds burning.—May 18.

Fires, Russia, sleeping car on railway between St. Petersburg and Warsaw destroyed; nurse and child burned to death.—May 31.

Fires, St. Boniface, Man., Royal Soap works completely destroyed.—May 25.

Fires, San Francisco, Russian Church destroyed.—May 22.

Fires, St. Sauveur, Quebec, 700 houses destroyed, Major Short and Sergt. Walleck killed.—May 10.

Fires, Trenton, Pictou, N.S., Hopkins Mrs., house of, burned, youngest child aged 2 years roasted alive.—May 12.

Fires, Virginia Beach, Princess Anne County, Va., residence of Rev. F. C. Clarke, pastor London Bridge Baptist Church, Mr. Clarke, two daughters, son and niece destroyed.—May 24.

Fires, West Chester, N. Y., dwelling of Watson Bownes destroyed, five persons burned to death.—May 7.

Fires, Winnipeg, Nickel Plate factory, Jewish Synagogue and other buildings destroyed.—May 5.

Fires, Worcester, Mass., Theatre destroyed.—May 10.

Flood, Johnstown, Pa., bursting reservoir submerges the town.—May 31.

Floods, Bohemia, 45 persons lost their lives through floods.—May 21.

Gas, Baltimore, Grant Joseph D., and wife, of Jefferson Democrat Association, found dead in bed.—May 30.

Lightning, Ridgeway, Pa., Mrs. W. McNail and four children killed by.—May 11.

Mining, Middleport, Pa., Raskatoon colliery, ten miners killed in ascending cage.—May 9.

Mining, Merthyr, Tydvil Wales, roof of colliery falls in, killing one miner and entombing 58 others.—May 23.

Mining, Wilkesbarre, Pa., bucket containing ton of rock falls from top to bottom of Pettibone shaft, six men crushed.—May 24.

Railway, Austria, train from Wiesbaden to Vienna conveying Empress of Austria and suite, while being shunted at Frankfurt, leaves the rails.—May 22.

Railway, Belleville, Ont., Ma100 train on Grand Trunk line dashed into by timber train, twenty persons injured.—May 18.

Railway, Bull Station on Housatonic railway. Two freight train collide, engineer Blood and brakeman Oels killed.—May 28.

Railway, Central Vermont between Roxbury and East Granville, Conn. freight train breaks apart, 159 hogs killed.—May 3.

Railway, Cleveland, Ohio, collision on Valley Railway, two persons killed and four injured.—May 8.

Railway, Corbyville, Ont., Madoc train run into by freight train, ten persons injured.—May 13.

Railway, Bailey Station, Col., Charles Lapman, fireman, killed by freight engine running off line.—May 13.

Railway, Buxtoo, Ont., Joseph Beachard, while driving across track, cut to pieces by express train.—May 10.

Railway, Dorval, P.Q., three freight trains collide on Grand Trunk Railway, terrible wreckage and loss of property.—May 17.

Railway, Madawaska, Ont., Meek W., bookkeeper of Kingston and Pembroke Mining Company, killed.—May 10.

Railway, Maynard, Ohio, freight train on Cleveland, Loraine and Wheeling railroad goes through a bridge into a creek.—May 3.

Railway, Nashville, Tenn., 17 men,—2 whites and 15 negroes—killed while putting out fire of bridge on Nashville, Chattanooga and St. Louis railroad.—May 19.

## ACCIDENTS.—Continued.

- Railway, Ormsby, Pa., wreck on Pittsburg, Virginia and Charleston Railroad, results in injury to eight workmen, two fatally.—May 16.
- Railway, Osgood Station, Ottawa, Andrew Matthews, brakeman on Prescott and Ottawa branch of C.P.R., killed while coupling cars.—May 11.
- Railway, Russia, sleeping car between St. Peterburg and Warsaw destroyed by fire, nurse and child burned to death.—May 31.
- Railway, Sullivan, Mo., Westbound train on St. Louis and San Francisco railway wrecked, forty-five persons injured.—May 23.
- Railway, Toronto, freight train crashes into Guelph train.—May 22.
- Reservoir bursting, Littleton, N.H., considerable damage caused by.—May 22.
- Shipping, Gloucester, N.J., ferry boat "Peerless" collides with ferry boat "J. S. Schultz," injuring seriously Flora Jackson and Annie Quinby.—May 16.
- Shooting, Peoria, Ill., Miss Jessie Bening accidentally shoots herself dead.—May 1.
- Shooting, L'Azare, Bellechasse, P. Q., David Labrie killed by accidental discharge of a gun.—May 5.
- Storm, Austria, Boskowitz, eight persons killed by lightning.—May 17.
- Storms, Austria, Vienna, 3 persons killed; Rackortz, 9 children killed; Zino, 30 persons killed.—May 18.
- Storm, Chamberlain, Dak., lightning strikes residence of Mr. Dorsey, killing his ten year old son.—May 15.
- Storm, Danville, Pa., J. G. Penn's tobacco factory blown down, 6 men killed.—May 30.
- Storm, Fairhaven, Conn., sixteen men injured by being thrown from building blown down by storm.—May 10.
- Storm, Potomac Valley, twenty-five men at work on railroad trestle swept into the water, and wreck of bridge falls on them.—May 10.
- Storm, Sunbridge, Ont., son of Mr. Thomas Smart killed by lightning.—May 20.
- Storm, Tacoma, W.T., new hotel blown down, 5 persons killed and others injured.—May 13.
- Tornado, Martinsburg, West Va., destruction on Potomac river; two men killed by falling of a barn.—May 30.
- AFRICA EAST, Captain Wissman has severe engagement with Chief Bushire's forces whose camp he captures.—May 8.
- Bejajmoya, Captain Wissman in a report reports troubles of missionaries.—May 1, reported May 27.
- Congo State, reports from state Armoehimi district, now under direct influence of Congo State Government, reported May 28.
- Zanzibar, Fever committing ravages among crews of English and German vessels.—May 15.
- Anarchists, Lombardy, land agitation fomented, houses ransacked, troops called out.—May 17.
- Anarchist, conspiracy discovered at Suca, Spain.—May 18.
- Anarchists, Milan, 17 arrested for inciting tumults at Gallarate.—May 23.
- Ancient order of United Workmen, seventh Annual convulse of the grand legion of, in Shaftesbury Hall, Toronto.—May 21.
- Ancient order of Hibernians, session of, at New York.—May 14.
- Annexation, Dr. Jamieson of Mountain, Ont., replies to Mr. Shibley of Providence, R. I.—May 8.
- Arbitration treaty, England and United States, Emilo Laveteyre publishes appeal to Mr. Gladstone to take lead in promoting.—May 28.
- Artists, Ontario Society of, exhibition at Toronto.—May 22.
- Artists, Ontario society of, annual meeting at Toronto.—May 28.
- Australia, Ballarat, immense meetings held at, in favor of Irish Home Rule.—May 16.
- AUSTRIA.—Boskowitz, eight persons killed by lightning.—May 17.
- Reichrath, Catholic Congress of Vienna, Premier Von Taaffe states Congress was purely private, and would not affect friendly relations between Austria and Italy.—May 16.
- Disastrous storms, 3 persons killed near Vienna, house collapsed at Rackortz, killing 9 children, at Zino 30 persons killed.—May 18.
- Socialists, government officially warned by Germany that German Socialist agitation among Austrian miners.—May 27.
- Bank of Montreal, annual statement.—May 10.
- Banks, Quebec, La Baouee Nationale, Annual Meeting and re-election of officers.—May 22.
- Banks, Savannah, Mo., Saving Bank, failure of.—May 29.
- Banks, Scranton, Pa., City Bank, vice-president George A. Jessup, arrested.—May 25.
- Bannatyne Hon. A. G. H., death of, at St. Paul.—May 18.
- Baptist Home Missionary Society, Boston, closing session of 57th Annual Meeting, election of officers.—May 18.
- Barry Mrs. Lenna, general investigator of Women's work in the Knights of Labor, interviewed at Cincinnati as to her visit to the South.—May 2.
- Bavaria, Queen Mary of, mother of King Otto, death of, at Munich.—May 16.
- Bavaria, Munich, newspaper confiscated, and editor arrested for publishing scandalous obituary article on Queen Maria.—May 21.
- BEHRING SEA, British flagships "Swiftsure" and "Amphion" sent to Sitka with orders to cruise in Behring Sea.—May 27.
- British warships to sail from Victoria, B. C., on June 15. Macdonald, Sir John, interviewed at Montreal thereon.—May 25.
- Revenue cutter "Rush" leaves San Francisco for.—May 30.
- Denial in British House of Commons that men of war ordered from Pacific station to Behring sea.—May 30.
- Secretary Windom signs the sailing orders of the revenue steamer "Bear" designated to assist in protecting the Alaska seal fisheries.—May 31.
- Revenue cutter "Rush" sails from San Francisco to protect American fishery interests.—May 24.
- Belfast, foundation stone of Albert bridge laid by Prince Albert Victor of Wales.—May 22.
- Belfast, new dock opened by Prince Albert Victor of Wales.—May 21.
- Belgium, Chamber of representatives, Prince Munster Bernaert strenuously denies that government was plotting the ruin of citizens through agency of police, spies-vote of confidence passed.—May 29.
- Belgrade, rioting at, ex-president Garashawine's house attacked, 3 rioters killed and a number wounded.—May 27.
- Belgrade, 100 arrests including ex-Premier Garashawine for riot.—May 30.
- Belleisle, straits of, Quebec Board of Trade decides that no sailing vessel should pass by the straits before first of July.—May 27.
- Bennington, Vt., Hotels, after a barricade of four weeks, open.—May 9.
- Bi-Metallic currency, Britain, Lord Salisbury receives deputation thereon.—May 31.
- Births, Princess Beatrice, wife of Prince Henry of Battenburg, of a son.—May 20.
- Bishop Washington Irving, mind reader, death of, at New York.—May 13.
- Bishop, Irving, inquest on, at New York.—May 28.
- Bishop Irving, New York, verdict on inquest.—May 30.
- Boehm Joseph Edgar, sculptor, created a baronet.—May 24.
- Bohemia, floods, 45 persons lose their lives.—May 22.
- Bonner Hugs, appointed chief of New York fire brigade.—May 21.
- Boulanger, Max O'Rell interviewed thereon, at London, Eng.—May 19.
- Bourne Mills Corporation, Fall River, Mass., decide to adopt plan of profit sharing with the operatives.—May 22.
- Brazilian parliament opened by Emperor.—May 4.
- Breweries, Newark, N.J., two more breweries added to the syndicate.—May 15.
- Breweries, New York, English syndicate purchases brewery of George Ringley & Co.—May 14.
- Breweries, North-West territory, twenty-four closed by order of Inland Revenue department.—May 24.
- Breweries, St. Paul, Minn., English syndicate buy up all breweries in.—May 22.
- Bridgenian Laura, made famous by Charles Dickens in his American notes dies at South Boston Asylum.—May 24.
- Bright Right Hon. John, will of, sworn to in England.—May 24.
- Brooklyn Bridge, trustees decide to double traffic facilities.—May 14.
- Brigands, Sofia, five brigands hanged.—May 16.
- Burns George, created a baronet.—May 24.
- Cabinet meeting, Washington, three cabinet officers, Blaine, Wiroom and Proctor, tender their resignation to President, it certain changes net made.—May 21.
- California, severe earthquake shocks felt in several parts.—May 19.
- Campbell Lord Walter, third son of Duke of Argyll, death of, in South Africa.—May 3.
- Canada, Parliament of, prorogation.—May 2.
- Canada, United States Senate Commission on trade relations with, arrives at Los Angeles, Cal.—May 14.
- Canadian Asbestos and Antimony Company, W. J. Spooner appointed official liquidator.—May 15.
- Canals, St. Lawrence, instructions issued from Ottawa as to Saturday and Sunday opening and closing hours.—May 30.
- Carnegie Andrew interviewed in London on the effects of the protective tariff.—May 25.
- Catholic Congress, Vienna, close of.—May 2.
- Catholic Congress of Vienna, Premier Von Taaffe states in Reichsrath that Congress was purely private, and would not affect friendly relations between Austria and Italy.—May 16.
- Catholic Knights of America, Supreme Council of, meets at Chattanooga, Tenn.—May 14.
- Catholic Knights of America, Coleman James D., of New Orleans, elected Supreme President.—May 18.
- Cattle, consumption among, at William Dalmage's farm at Camden, Ont.—May 14.

Chanel Island, earthquake prolonged shock of, felt.—May 30.  
 Chicago, monument erected in honor of policemen killed by anarchist bomb in 1886 unveiled.—May 30.  
 Chicago Board of Trade votes to discontinue furnishing quotations to all persons, except members of the board.—May 14.  
 Chicago, Insane Asylum, investigation into.—May 13.  
 Chicago, drainage bill passes Illinois Senate.—May 22.  
 CHINA, Che Foo riots, damages arising out of, settled, English and American flag rehoisted.—May 17.  
 Hong Kong, heavy storm at, immense damage caused.—May 29.  
 Chinese Exclusion Act, Supreme Court of U. S. affirms validity of the law.—May 13.  
 Cholera, India, 1000 persons die within a week in the Ganjaw district.—May 24.  
 Cleveland, ex-president, banquet to, at New York by Young Men's Democratic Club.—May 27.  
 Collieries, Pittston, Pa., railroad and coal companies order their men to resume work on full time.—May 21.  
 Commercial Union, Wiman Mr. Erastus, address of, at Harmony Hall, Ottawa.—May 4.  
 Congo, Conference at Berlin, Prince Leopold of Belgium proposes international conference to complete the work.—May 7.  
 Conservative convention, Montreal.—May 29.  
 Cook County, Ill., Insane Asylum, investigation into affairs of.—May 13.  
 Consumption among cattle at William Dulmage's farm at Camden, Ont.—May 14.  
 Conductors, railway, twenty-first annual convention opened at Denver, Col.—May 14.  
 Cotton Manufacturers, Augusta, Ga., convention held at, and permanent organization formed.—May 1.  
 Corea, Yeko, riot in consequence of execution of Boker quelled by the Military, April 13.—Reported May 11.  
 Corwith Nathan, well known citizen of Chicago, death of.—May 29.  
 Cotton, John B., of Lewiston, Me., appointed by president assistant attorney general.—May 29.  
 County Councils, England, decision in Lady Sandhurst case.—May 16.  
 Robbery, Newcastle, Del., five negroes and seven whites whipped.—May 12.  
 Crete, Greece annexed to assembly of the Island adopts resolution in favor of.—May 27.  
 Customs, Canadian cars, deputation waits upon Secretary Windom at Washington regarding dutiable character of Canadian car.—May 8.  
 Customs, San Francisco, seize 1,000 pounds of smuggled opium on board steamer "City of New York."—May 10.  
 CRIME.—Absconders, (Chicago, Fairbanks John, treasurer of National Union Building Association, action to recover bond of guarantee for faithful performance of duties brought against Bishop Fallows.—May 3.  
 Abduction, Toronto, Donbar Katie found dead, woman named Wright arrested.—May 31.  
 Absconders, Tacoma, W. T., McCornick J. E., disappears, with over \$50,000.—May 8.  
 Absconders, Toronto, Shaw Charles A., manager of Toronto Opera House, goes to New York.—May 9.  
 Absconders, Baltimore, Thomas McGatchia who stole \$8,000 from Unlimited Oil Company arrested in Jacksonville, Fla.—May 29.  
 Absconders, Ottawa, Brown W. E., ex-alderman arrested at Massene Spring, N. Y.—May 23.  
 Defaulters, New Haven, Conn., Bradley John C., cashier of Merchants National Bank.—May 25.  
 Forgery, Windsor, Ont., Henry Gottlieb, Chicago lawyer, arrested, and consents to go back to Chicago without extradition.—May 20.  
 Robbery, Chicago, Post Office vault entered and 86 registered letters stolen.—May 26.  
 Robbery, Sherman, Miss., Langlate stage mail robbed.—May 21.  
 Robbery, train on Milwaukee and North Western railroad at Beaver, Wis., men walks through the train with revolver and compels passengers to yield up valuables.—May 29.  
 Cronin Dr. P. H., body of, found in Chicago.—May 22.  
 Customs, Canadian, Spanish river all of Modes Bros. removed from, Detour seized for duty.—May 27.  
 Cyclone, Lackawanna Valley, Pa., great damage wrought.—May 20.  
 Danville, Va., Venn's tobacco factory blown down, 6 men killed.—May 30.  
 Corwith, Nathan, of Chicago.—May 29.  
 DEATHS.—Campbell Lord Walter, third son of the Duke of Argyll, in South Africa.—May 3.  
 Baumtayne Hon. A. G. B., at St. Paul.—May 18.  
 Bivariva, Queen Mary of, mother of King Otto, at Munich.—May 16.  
 Bishop Washington Irving, mind reader, at New York.—May 13.

## DEATHS.—Continued.

Bridgeman Laura, made famous by Charles Dickens a his American notes, dies at South Boston Asylum.—May 24.  
 Damien Rev. Father, "Leper Priest of Molokai," dies at Kalawa, Hawaii.—April 19, rep. May 9.  
 Dickinson Mrs. Mary M., mother of Susan E. Dickinson the writer, at Pittston, Pa.—May 12.  
 Dunlop H. A. L., of Calgary, member of Winnipeg's Crack Cricket Team.—May 22.  
 Foster Hon. Henry A., ex United States senator, at Rome, N. Y.—May 12.  
 Foss Mr. S. J., postmaster of Sherbrooke, P. Q.—May 7.  
 Huntington Hon. Daniel, at Shediac, N. B.—May 5.  
 Harvey General William, oldest officer of United States Army, at Orlando, Fla.—May 9.  
 Hoskin, commander of flagship "Swiftsure" dies at Esquimaux.—May 20.  
 Meyer Herr, ivory importer, at Kiel.—May 3.  
 Noble Hon. Guy C., prominent lawyer, at St. Albans, Vermont.—May 21.  
 Pelham George B., architect of Government buildings, Ottawa, death of, at New York.—May 2.  
 Power Most Rev. Pierce, Bishop of the Catholic diocese of Waterford and Lismore.—May 22.  
 Rice Mr. Allen Thoradyke, newly appointed Minister to Russia, at New York.—May 16.  
 Rogers Major A. H., discoverer of Kicking Horse Pass, of death, at Waterville, Minn.—May 5.  
 Ryan Hon. Thomas, at Montreal.—May 23.  
 Tolstol Count, Russian Minister of the interior.—May 7.  
 Watson Mrs. Charles T., reader and actress, in New York.—May 4.  
 Wright William, L. D., professor of Arabic in University of Cambridge.—May 23.  
 Dickinson Mrs. Mary E., mother of Susan E. Dickinson, the writer, dies at Pittston, Pa.—May 12.  
 DIPLOMATIC.—Pannecofte Sir Julian, New British Minister to United States, presented to President.—May 3.  
 Grant Col. Frederick, new American Minister to Austria, arrives in Vienna.—May 10.  
 United States appointments, Kirsch to Turkey, Severance to Sandwich Islands, Carr to Denmark, Sherman consul at Liverpool, Jarrett consul at Birmingham.—May 17.  
 United States and France, Pres. Carnot receives Whitelaw Reid, New American Minister at Paris.—May 21.  
 United States and Great Britain, Mr. Lincoln presented to Lord Salisbury at foreign office, London.—May 23.  
 Divorce, Chicago, Carter case, verdict returned in favor of Mr. Carter.—May 22.  
 Duels, Vienna, Prince Alexis Schwarzenberg fatally wounded in duel with Lieutenant of Hussars.—May 30.  
 Dufferin Lord, presented with freedom of City of London for annexing Burmah.—May 29.  
 Earthquake, Annapolis, Ind., shock felt at.—May 11.  
 Earthquake shocks, California, severe shocks felt in several parts.—May 19.  
 Earthquake, Channel Islands prolonged shock felt.—May 30.  
 Earthquake, many towns on Mainland of England and France.—May 30.  
 Earthquakes, Paris, earthquake shock felt on left bank of the Seine.—May 30.  
 Earthquakes, Tokio, Japan, earthquake of most unusual character recorded in Seismological Observatory of Imperial University.—April 18, rep. May 22.  
 ECCLESIASTICAL.—Buckingham, Que., Evans Rev. Mr., drowned by upsetting of a canoe.—May 9.  
 Baltimore, suicide of Rev. H. G. Schorr, assistant rector of St. Paul's episcopal church, shoots himself.—May 27.  
 Brooklyn, Deut. Rev. Father Francis sues Bishop Ryan of Buffalo and others for libel.—May 15.  
 Duncan Rev. Father, "Leper Priest of Molokai," dies at Kalawa, Hawaii.—April 19, rep. May 9.  
 Elmsierian Church, London, meeting to found, held at Anderson's hotel.—May 11.  
 Hamilton, Bishop Dowling enthroned in St. Mary's Cathedral.—May 2.  
 Mexico, Bishop Moreno arrested at Silos, for wearing Cassock in the streets, and fined.—May 8.  
 Presbyterian Assembly, New York animated discussion on prohibition.—May 27.  
 Presbyteries of Portage la Prairie, Brandon and Winnipeg, Man., nominate Principal Grant for moderatorship.—May 8.



ECCLESIASTICAL.—*Continued.*

Richmond, Va., Rev. John Jasper's revival, 200 converts baptized in James River.—May 12.

Boston, American Baptist Home Missionary Society, closing session and election of officers.—May 18.

Newark, N. J., annual convention of Episcopal diocese of, opened, Bishop Starkey's address.—May 21.

Nova Scotia, Archdeacon Gilpin promoted to be Dean, and Rev. J. A. Kambick of Truro, archdeacon.—May 24.

Ottawa, session of Ottawa district of Montreal conference of Methodist church.—May 22.

Power Most Rev. Pierce, bishop of Catholic diocese of Waterford and Lismore, death of.—May 22.

Prince Edward Island, Rev. Weston Jones of Charlottetown made Archdeacon.—May 24.

Rome, Pope declines to nominate Polish and Russian bishops at Consistory.—May 18.

Rome, Pope in allocution protests against Italian legislation, denounces proposed monument to Gregory Bruna, and refers to recent Catholic Congress.—May 24.

Toronto Presbytery nominates Principal Grant for the moderatorship.—May 7.

Edinburgh Municipal Council confirms resolution granting freedom of city to Mr. Parnell.—May 8.

EGYPT.—Wady, Hulla, six dervishes executed for outraging women and children, despatches received.—May 3.

Suakin, expedition to Halaib returns, having completed fortifications there.—May 13.

Soudan, Capt. Wissman's contingent, small-pox broken out among.—May 31.

Wissman Captain, announces he will declare war against all coasts Arabs from Tonga to Lindi unless they submit before June 1.—May 28.

ELECTIONS.—Compton, Munroe Mr. T. B., chosen as candidate by Liberals.—May 2.

Compton, P. Q., nomination of Messrs. Pope and Munroe.—May 9.

Compton County, P. Q., Mr. Rufus H. Pope returned to Dominion parliament.—May 16.

Centre Winnipeg, Henderson W. F., accepts nomination against Col. McMillan.—May 10.

Centre Winnipeg, Mr. W. F. Henderson withdraws from candidature.—May 10.

France, Charcuton, another ballot ordered at where Boulanger defeated for Municipal Council by two votes.—May 22.

France, Boulanger's supporters decide to contest all elections.—May 15.

France, Aisne and Doubs departments, M. M. Leroux and Bernard, republicans elected senators.—May 26.

France, St. Ouen's Municipal Government, Boulanger, Laguerre Naquet and de Roulede elected on second ballots.—May 5.

Holland for members of Provincial Assembly.—May 30.

Lafayette, La., band of armed men prevents negroes from voting, polls closed.—May 6.

Quebec, west local election annulled for corrupt practices.—May 4.

Three Rivers, P. Q., Court of review, petition of method against Hon. Mr. Turcotte, dismissed.—May 31.

West York, Ont., Turner Mr. J., of Brackendale, nominated by Conservatives for Ontario Legislature.—May 18.

Winnipeg Centre, Provincial Treasurer McMillan elected by acclamation.—May 18.

Elopiements, Hartford, Conn., Deacon Asher P. Smith runs away to Canada with his cashier Miss Josephine King.—May 27.

Elopiements, New York, Hooper Rev. John, of North New York Congregational Church, elopes with May Curtis, pair married in New Jersey.—May 17.

Elmsierian Church, London, Eng., meeting to found, held at Auderton's hotel.—May 11.

Emerald Beneficial Association, Ontario Branch, close of Convention at Toronto.—May 23.

Emigration of poor children, discussion in British House of Commons.—May 10.

Engineers, Brotherhood of Locomotive, Scranton, Pa., secret meeting of 500 members held.—May 26.

Esquimaux to be garrisoned by Royal Marine Artillery, question discussed in British House of Lords.—May 16.

Eton College, Eng., Queen lays foundation stone of new building.—May 18.

Exeter, Ont., several buildings struck by lightning.—May 10.

FAILURES.—Canadian Asbestos and Antimony Company, W. J. Spooner appointed official liquidator.—May 15.

FAILURES.—*Continued.*

Chicago, Western Arms and Cartridge Company.—May 22.

London, Eng., Mandeville arranges scheme to satisfy his creditors.—May 13.

New York, Electric Sugar Refinery Company, receiver appointed.—May 10.

Ottawa, Harkin T. B., & Co., shoe merchants.—May 20.

Philadelphia, Alum Manufacturing Company.—May 18.

Quebec, St. Lawrence Warehouse, Dock and Wharfage Company.—May 10.

Quebec, Fraserville Shoe Manufacturing Company.—May 27.

Savannah, Mo., Savings Bank.—May 29.

Scranton, Pa., City Bank, Vice-President, George A. Jessup, arrested.—May 25.

Worcester, Mass., Ayer A. E., & Co., stock brokers, liabilities \$50,000.—May 24.

Fargo, Dak., cyclone does much damage.—May 6.

Fever, Zanzibar, ravages committed among crews of English and German vessels.—May 25.

Fisheries, Halifax, N.S., Canadian cruiser "Vigilant" seizes Gloucester Schooner "Mattie Winslip" about two miles off Cape North, C.B.—May 31.

Flannels, New York, sale of 12,000 packages finished.—May 29.

Fisheries, Halifax, Minister of Marine and Fisheries decides to establish intelligence department, for the purpose of supplying information to fishermen as to various food and bait fishes.—May 20.

Flour, English Syndicate attempting to purchase great flour mills of America.—May 22.

Flour, Messrs. McKay & Co.'s flour mill at Ottawa suspends operations owing to the high prices of wheat.—May 7.

Forestburgh, Sullivan County, 1,700 acres is purchased by Manhattan Single Tax Club of New York.—May 28.

Fort McLeod, fight between Bloods and Cowboys and Gros Ventres, a number killed and scalped.—Reported May 21.

Fort Wayne, Ind., Saloons all closed.—May 19.

Foss Mr. S. L., postmaster of Sherbrooke, P. Q., death of.—May 7.

Foster Hon. Henry A., ex-United States Senator, death of, at Rome, N.Y.—May 12.

FRANCE, centenary celebration at Versailles, President Carnot fired at by man named Perrin, with a blank cartridge.—May 5.

Boulanger, trial of, at Paris, postponed till August.—May 24.

Boulanger's supporters decide to contest all elections.—May 25.

Chambers of Deputies. The Boulanger Trial by Senate, Government upheld in their refusal to be interpellated.—May 28.

Exhibition, opening of, by President Carnot.—May 7.

Gilly M. Numa, member of Chamber of Deputies, tried at Montpellier, on charge of libelling M. Salis, and sentenced to imprisonment.—May 17.

Narbonne, municipal election results in victory for socialists.—May 12.

Nice, three American ladies arrested and thrown into prison at the instance of a dress maker.—May 3.

Paris, shock of earthquake felt on left bank of Seine.—May 31.

Paris Exhibition, upwards of 100 members of British House of Commons append their signatures to Memorial to President Carnot, expressing regret at absence of British Ambassador from opening function.—May 13.

Paris Exhibition, visit of Lord Mayor.—May 15.

Paris Exhibition, Eiffel Tower opens.—May 15.

Paris Exhibition, absence of Lord Lytton from opening ceremonies discussed in British House of Commons, and action of Government endorsed.—May 28.

Paris, Rochefort's son, funeral of, riot with the police.—May 7.

Paris, banquet given by delegates of American Republics taking part in Exhibition, in honor of the Cabinet.—May 18.

Paris, President Carnot receives Whitelaw Reid, new American Minister at Paris.—May 21.

Poirier, an opportunist, elected Senator in the department of the Seine.—May 12.

St. Ouen's municipal Government, Boulanger, Laguerre, Naquet and de Roulede elected on second ballots.—May 5.

Senate examines MM. Granet and Lockroy as to meeting held on the eve of the election of Mr. Carnot.—May 8.

Senate, students for priesthood exempted from military service after a year's drill.—May 17.

Senate, Military Bill, amendments again adopted which Chamber of Deputies before refused to accept.—May 17.

Freight handlers, Boston, employed in Fitchburg railroad yards, decide to demand increase in wages.—May 22.

Freights, Iron Ore, Western agents decide to reduce rates on iron ore from Lake Ports to Pittsburg.—May 22.

Frogs, Jamestown, Dak., shower of.—May 7.

Gambling, London, Eng., police raid the Field and Adelphi clubs.—May 12.

Gambling, London, Eng., Field Club, Mr. Seaton, proprietor, fined £500.—May 20.

GERMANY, Hamburg, thirty persons arrested for selling Socialist pamphlet.—May 6.

Berlin, King Humbert, the Crown Prince of Italy, and Signor Crispi arrive.—May 21.

Elisenheim, affray between villagers and military, seven persons killed.—May 13.

Freight rates reduced by Prussian Government on all lines to alleviate distress arising from dearth of coal.—May 18.

Frenchmen arrested at Sultzmatz, Alsace, on charge of treason.—May 24.

Reichstag, Army bill, scene between Prince Bismarck and Herr Richter.—May 18.

Reichstag, reception accorded King Humbert in Berlin, President reads letter from Bismarck enclosing telegram from Italian Chamber of Deputies to Premier Crispi, congratulating him upon reception.—May 22.

Striking miners, serious conflicts between troops and strikers.—May 11 and 12.

Gladstone Mr., receives addresses of sympathy signed by Governors, Senators, and other State officials of Minnesota and Wisconsin.—May 18.

Gladstone Mrs., presented with bracelet by Women's Liberal Association, in celebration of her golden wedding.—May 22.

Glass, Window Glass Workers Association issues order that all foreign glass workers coming to United States be blacklisted.—May 10.

Gold, Glen Dive, Mont., discovery of.—May 14.

Gold, New York, one million five hundred thousand dollars ordered for shipment to Europe.—May 4.

Gold, New York, half a million dollars exported from.—May 10.

Gold, New York shipments to London and Paris, \$3,500,000.—May 25.

Good Templars, Independent Order of, Chicago, Supreme Grand Lodge of the World begins its biennial session.—May 28.

Grain Examiners and Arbitrators, Toronto Board of, order in council passed limiting powers of.—May 29.

Grasshopper plague prevailing at Manitoulin Island.—May 21.

Halifax, Bermuda Cable Company issuing £120,000 sterling 4½ per cent. debentures at 2 premium.—

Hawington Hon. Daniel, death of, at Shediac, N. B.—May 5.

Harcourt Sir William Vernon, speaks at Bramley on the 30,000 men employed to coerce Ireland.—May 8.

HAYTI, Minister Preston informed that Legitime's army has taken by assault town of Ennary.—May 17.

Legitime's forces routed, four towns captured by Hippolyte, many persons slain.—Reported May 21.

Gen. Wallace and ex-Consul Packard selected by U.S. Government to go and use influence to secure peaceable settlement of troubles there.—May 24.

Port au Prince in the hands of a mob, an attack expected by Hippolyte's Army.—May 21, reported May 28.

Minister Preston declares the Dominion Government has virtually recognized Legitime.—May 27.

Despatches received at London from Gen. Hippolyte, the insurgent leader, saying he has defeated President Legitime, captured Port au Prince and proclaimed himself President.—May 31.

Hewitt Abraham S., interviewed at New York by *Herald* on the Basic process for making open hearth steel.—May 14.

Hibernians, Ancient Order of, session at New York.—May 14.

Holland King of, Parliament passes resolution restoring his power.—May 2.

Holland, The Hague, body of socialists hauls down Royal Standard from great tower, and hoists socialist flag.—May 12.

Holland, elections for members of Provincial Assembly.—May 29.

Hoskin, commander of flagship "Swiftsure," dies at Esquimault.—May 20.

Hungarian merchants boycotting grain market of Vienna, in consequence of growth of anti semitism.—May 9.

Hypnotism exhibitions of, forbidden by Executive Council of Swiss Confederation at Berne.—May 20.

Illinois Senate, Chicago drainage bill passes.—May 22.

Imperial federation league addressed by Earl of Rosebery.—May 24.

Imperial federation, Hamilton, address by Rev. Dr. Grant of Kingston.—May 11.

IMPERIAL PARLIAMENT, Commons, Budget discussed, main proposals approved.—May 2.

Commons, Charles Conybeare, M. P., conviction of, attempt to discuss same by Mr. L. A. Jones defeated.—May 6.

Commons, Newfoundland fisheries, Government will support British subjects in lobster fisheries, provided they do not interfere with French treaty rites.—May 7.

Commons, Halifax, Bermuda cable, copy of contract presented.—May 7.

Commons, Naval defence bill passes its second reading.—May 7.

Commons, Halifax, Bermuda cable, contract for, approved.—May 10.

Commons, emigration of poor children, discussion on.—May 10.

Commons, Sugar Bounties and United States Government, discussion thereon.—May 10.

Commons, Viceroyship of Ireland, proposal to send a Royal Prince.—May 13.

Commons, naval bill passes committee stage.—May 13.

Commons, Balfour Mr., states ten Irish members of the house now in prison, for offence under Crimes Act.—May 16.

Commons, perpetual pensions, Mr. Bradlaugh's motion opposing proposal of Government to commute, rejected.—May 16.

Commons, House of Lords, abolition of debate on.—May 17.

Commons, Naval defence bill passes third reading.—May 20.

Commons, Ireland, Chief Secretary for, questioned as to league for the purpose of placing Protestants on farms from which Catholics evicted.—May 27.

Commons, Luggacurran evictions debate upon.—May 27.

Commons, Healy Mr. Tim, M. P., protests against dinner given in the dining room of the house by Mr. Matthews, house Secretary.—May 27.

Commons, absence of Lord Lytton from opening ceremonies of Paris Exhibition, course of Government approved.—May 28.

Commons, Behring Sea, Sir James Ferguson denies that men-of-war ordered from Pacific station.—May 30.

Commons, Scotch Local Government Bill read second time.—May 30.

Commons, Bill for drainage and improvement of the Shannon and for the construction of railroads in Ireland introduced.—May 31.

Lords, proposal by Earl of Meath, to allow women to sit in County Councils, rejected.—May 20.

Lords, Equipault to be garrisoned by Royal Marine Artillery.—May 16.

Lords, marriage with deceased wife's sister, bill rejected.—May 9.

Lords, term of power in Europe, Lord Salisbury makes remarkable speech as to.—May 27.

Lords, Naval defences, bill passes second reading.—May 28.

Indianapolis Sunday law rigidly enforced.—May 26.

Indians, Cherokee, opposition among, to the sale of Cherokee strip to United States.—May 11.

Indians, Standing Rock, Dak., hold council, and agree not to sign treaty unless paid \$11,000,000 for their land.—May 19.

Insane Asylum, Chicago, investigation into.—May 13.

Insane Asylum, Cook County, Ill., investigation into affairs of.—May 13.

Insanity, Brenham, Tex., Brant Mrs. Randolph, kills two of her children aged four and six years, and escapes with youngest child.—May 27.

Interstate Commerce Commission resumes hearing at Chicago of case of Board of Trade against Western Railroad.—May 28.

Interstate Commerce, Senate Committee, President Smith, J. H. Henick and John J. Kernan give evidence, committee adjourns until July 5.—May 10.

Interstate commerce, Senate committee on, begins its investigation in New York as to Canadian railroad companies.—May 3.

Interstate Commerce, Senate Committee on Canadian Railroads, Albert Fink, chairman of Trunk Line Association, gives evidence.—May 6.

Interstate commerce, Senate Committee, Channey M. Depew and Mr. Joseph Hickson give evidence.—May 7.

Interstate commerce, Senate Committee, Thomas Lyman, railroad expert, James J. Hill president of St. Paul, Minneapolis and Manitoba railroad, and Mr. Erastus Wiman give evidence.—May 8.

Interstate commerce, Senate committee, Mr. W. C. Van Horne, president of Canadian Pacific Railway, testifies.—May 9.

IRELAND, Cork, Jack Hickey, Irish pugilist, breaks the jaw of a car driver and kills him.—May 8.

Belfast, Carew Mr. J. L., M. P. for North Kildare, released from prison.—May 20.

## IRELAND.—Continued.

Ballymena, Lawlor John H., Manager of Ballymena Branch of Provincial Bank of Ireland shot dead on road.—May 31.

Bill for drainage of Shannon, and construction of railroads introduced into British House of Commons.—May 31.

Bowell estate in Cork, evictions, boy named Shea fatally injured.—May 31.

Dublin, National league, Professor Galbraith denounces proposal to abolish the office of Viceroys.—May 21.

Falcearragh, Charles Conybeare, M. P., sentenced for conspiring to oppose the law.—May 3.

Falcearragh, conflict between evictors and tenants, 25 policemen injured.—May 27.

Keller Rev. Canon commences action against Mr. Balfour, Irish secretary, for slander.—May 15.

Luggacurran evictions, debate upon in British House of Commons.—May 27.

Luggacurran estate, eight tenants evicted.—May 28.

Lord Landsdowne's Luggacurran estate, evictions completed.—May 31.

O'Brien Patrick, M. P., brings action for libel against London *Times*, Liverpool *Courier* and Thomas Wallace Russell, M. P.—May 16.

Orders issued to prison authorities to release from gaol William O'Brien and Timothy Harrington.—May 4.

Sir William Vernon Harcourt speaks at Bromley for the 30,000 men employed in coercion.—May 8.

Tipperary, Dr. Tanner and Messrs. O'Connor and Condon, sentences affirmed upon, riot at Clonmel upon their arrival.—May 2.

Vandeleur Estate, Sir Charles Russell, arbitrator in disputes between Tenants and Landlords, makes his award.—May 4.

Viceroyship proposal in British House of Commons to send Royal Prince.—May 13.

Viceroyship, meeting of Unionist members of Lords and Commons meet at residence of Marquis of Waterford, and adopt memorial praying for abolition of Viceroyship and for a royal residence in Ireland.—May 21.

Walsh, Archbishop of Dublin, writes urging arbitration in disputes between Landlords and Tenants.—May 7.

Zetland, Earl of, appointed Lord Lieutenant.—May 29.

Irish Home rule advocates, Dillon, Deasy and Esmonde, arrive at Sydney, N. S. W.—May 29.

Irish Home rule, Australia, immense meetings held at Ballarat.—May 16.

Parliament, introduction of budget.—May 16.

Irish Viceroyalty, deputation of Unionist members of Lords and Commons waits on Lord Salisbury and present petition, asking for abolition of office.—May 29.

Iron Guthrie, Oklahoma, rich mines discovered near.—May 30.

Irving Bishop, New York, verdict on request.—May 30.

ITALY.—Chamber of Deputies, Abyssinia, Premier Crispi says as soon as treaty of peace is signed, Italian Government proposes to give Messowab a civil administration.—May 8.

Milan, Anarchists, 17, arrested for inciting tumults at Gallarate.—May 23.

Jamestown, Dak., shower of frogs.—May 7.

Japan, Kioto, heavy floods do great damage in.—Reported May 22.

Japan, Tokio, earthquake of most unusual character recorded in Seismological Observatory of Imperial University.—April 18, reported May 22.

Japan, Yokohama, Journalists punished for publishing cartoon of new liberal constitution.—Reported May 22.

Jefferson, Ill., Lunatic Asylum, brutality practised upon lunatics, one man, Robert Burns, beaten to death by keepers, details brought to light.—May 2.

Joeky Club, warns Lord James Douglas off New Market course for defaulting bets.—May 30.

Johnstown, Pa., bursting reservoir submerges the town.—May 31.

LABOR.—Knights of, Barry Mrs. Lenora, general investigator of women's work in the Knights of Labor, interviewed at Cincinnati as to her visit to the South.—May 2.

Land Syndicate purchases 50,000 in Norfolk County, Va., and Currituck and Camden Counties, North Carolina, for farms.—May 14.

LEGAL.—Chicago, Bishop Samuel Fallows, of Reformed Episcopal Church, sued by National Union Building Association on bond as to John Fairbanks, treasurer of association.—May 3.

Brooklyn, Dent Rev. Father Francis sees Bishop Ryan of Buffalo and others for libel.—May 15.

Chicago, Carter divorce case, verdict returned in favor of Mr. Carter.—May 22.

Cobourg, Ont., Connee and MacLennan vs Canadian Pacific Railway hearing of.—May 20.

## LEGAL.—Continued.

Compton County of Magistrates, Court established in to be held at Megantic.—May 27.

Cotton John B., of Lewiston, Maine, appointed by president assistant Attorney General.—May 29.

Ireland, O'Brien Patrick, M. P., brings action for libel against London *Times*, Liverpool *Courier* and Thomas Wallace Russell, M. P.—May 16.

Ireland, Keller Rev. Canon commences action against Mr. Balfour, Irish Secretary, for slander.—May 15.

London, Eng., Court of Appeals decides in Lady Sandhurst's claim to sit on London County Council.—May 10.

London, Eng., Canada Shipping Company, judgment with costs against, for £2,400 loss upon grain cargo to Dublin.—May 7.

London, England, Greenwood vs. St. James' *Gazette*, jury discharged, unable to agree.—May 21.

London, Eng., Mackenzie Sir Morell, brings libel proceedings against Mr. Steinkoft and the *Times*, for publishing letters produced in Greenwood case.—May 23.

Montreal, Jesuit Fathers vs. Toronto *Mail*, argument on the exception to form of plea.—May 11.

Montreal, Society of Jesus versus "The Mail," judgment as to plea.—May 14.

New York, Electric Sugar Refinery Company dissolved by Judge Barrett, a receiver appointed.—May 10.

New York, Edison Thomas A., begins suit against Ezra Gilliland of Boston, and lawyer Tomlinson of New York, to recover \$250,000.—May 11.

New York, suit of Dr. Charles E. Simmons, against estate of Samuel J. Tilden for \$143,500, Judge Ingraham decides case must be tried before a jury.—May 24.

Ottawa, argument in Supreme Court in appeal of Canadian Pacific Railway vs. Western Union Telegraph Company.—May 8.

Ottawa Supreme Court, Canadian Pacific Railway vs. The Little Seminary of St. Theresa, argument heard.—May 13.

Philadelphia, Andrew Quin vs. Philadelphia Railroad, verdict for plaintiff \$12,000.—May 24.

Philadelphia, Henry Specht against Pennsylvania railroad, verdict for plaintiff \$20,000.—May 24.

Portland, Oregon, and Trans-Continental Company restrained from issuing new preferred stock.—May 17.

Quebec Bar Association, annual meeting and election of officers.—May 1.

St. Albans, Noble Hon. Guy C., death of.—May 21.

Toronto, Farquhar E. and C., against John Ross Robertson, proprietor of *Evening Telegram*, judgment in libel suit.—May 3.

Toronto, injunction served by town of Cobourg to restrain federation of Victoria College to Toronto University.—May 2.

U. S. Supreme Court affirms validity of law excluding Chinese laborers.—May 13.

United States Supreme Court, Robert Shields vs. Omaha Town Site Company case decided in favor of Shields, damages assessed at \$22,000,000.—May 23.

Washington, Attorney General Miller accepts place on Supreme bench, made vacant by death of Justice Matthews.—May 21.

Webster Sir Richard, Attorney General, banqueted by London solicitors.—May 29.

Lincoln Robert T., newly appointed U. S. Minister to England, given farewell banquet at Union League Club, Chicago.—May 7.

Lombardy, Anarchists fomenting land agitation, number of houses ransacked, troops called out.—May 17.

Lonsdale Lord, arrives at Winnipeg from San Francisco.—May 7.

Lumbermen, Frizes River, B. C., valuable limits secured.—May 20.

Lumber, Muscovia, lumber companies and others sell 320,000 acres of yellow pine land to English syndicate.—May 30.

Lynching, Port Huron, Mich., Martin molatto tramp, who outraged Mrs. Gillies, lynched.—May 28.

Mackenzie Sir Morell, brings libel proceedings against Mr. Steinkoft and the *Times*, for publishing letters produced in Greenwood case.—May 23.

McCConnell Mr. B. D., appointed Engineer to Montreal City Water Works.—May 6.

Mails British, Cunard Steamship Company and Oceanic Steam Navigation Company secure contracts to carry outward mails.—May 31.

Manhattan, Single Tax Club of New York purchase 1,700 acres in Forresterburg, Sullivan County, to erect club house, etc.—May 28.

Manitoba Government decide to locate new reformatory at Brandon, deaf and dumb institute at Portage la Prairie and home for incurables in Winnipeg.—May 27.

Manitoulin Island, grass-opper plague prevailing at.—May 21.

Mausen Dr., and companions, on exploring expedition to Greenland, arrive at Copenhagen on their return.—May 21.

Manufacturers, Augusta, Ga., convention held at, and permanent organization formed.—May 1.

Marlborough Duchess, presentation of, at Court.—May 5.

MARRIAGES, Archduchess Marguerite Clementine of Austria to Prince Albert of Thurn and Texas, betrothal of, proclaimed.—May 17.

Czarewitch of Russia to Princess Alice of Hesse, projected marriage cancelled.—May 27.

Duc D'Orleans, son of the Comte, Paris and Princess Marguerite daughter of Duc de Chartres, marriage arranged between.—May 27.

Jackson, Mich., Folsom Mrs., mother of Mrs. Grover Cleveland, to Henry E. Perrine of Buffalo.—May 20.

New York, Fanny Davenport, actress, to Melbourne McDowell, leading man in her dramatic company.—May 19.

Paris, Dunlop Snigh, Indian prince, to Miss Ada Wetherell.—May 20.

Prince Ferdinand of Bulgaria to Princess Alice of Hesse, betrothal of.—May 18.

Princess Millyre, second daughter of Prince of Montenegro, Grand Duke Peter of Russia, betrothal of.—May 30.

Tahiti, U. S. Consul Jacob L. Doty engaged to Princess Polona.—May 15.

Washington, Bayard ex-Secretary, and Miss Mary Willing Aymer, engagement of.—May 10.

Meyer Herr, ivory importer, death of, at Kiel.—May 3.

Meteorological, Central Illinois, tremendous heat wave, temperature at Bloomington reached 96, highest in May for twenty years.—May 9.

Meteorological, Chicago, signal service thermometer registers 88, hottest day in May since office established in 1871.—May 8.

Meteorological, Geneva, Ill., considerable damage caused by storm.—May 10.

Meteorological, Germany, Peterswalden flooded, much damage done in Berlin.—May 17.

Meteorological, Hudson, severe electric storm along.—May 14.

Meteorological, New York, thermometer registers 92.—May 10.

Meteorological, Northern Wisconsin and Michigan, fall of from three to five inches of snow.—May 16.

Meteorological, Pittsburg, Pa., great damage by storm.—May 10.

Meteorological, Antoine Creek, Ont., cyclone strikes camps of Rochester and Doherty, one man killed and another badly hurt.—May 19.

Meteorological, Findlay, Ohio, blighting frost prevails.—May 25.

Meteorological, Laekawanna Valley, Pa., cyclones cause great damage.—May 20.

Meteorological, Leavenworth, Kas., 50 to 65 inches of rain fall in 48 hours.—May 18.

Meteorological, Quincy, Ill., terrific wind and rainstorm does considerable damage.—May 26.

Meteorological Society, New South Wales Coast, hurricane extends over, rainfall never equalled, railway traffic suspended, number of lives lost.—May 29.

Meteorological, Troy, N.Y., disastrous May storm and freshet at Stillwater and Sandhill.—May 21.

MILITARY.—United States, Harvey General William, oldest officer in army, death of, at Orlando, Fla.—May 9.

Canada, Major Short and Sergt. Waldeck killed at St. Sauveur fire.—May 16.

Canada, Militia, general orders issued governing the annual drill of volunteer militia for present season.—May 11.

Canada, Militia department authorizes Quebec Seminary to form another Military school battalion.—May 21.

Canada, Drury Capt. C. W., promoted to major-vice the late Major Short.—May 28.

France, students for priesthood exempted by Senate from military service after a year's drill.—May 17.

France, Military bill, Senate again adopts amendment which Chamber of Deputies before refused to accept.—May 17.

Germany, Metz military tribunal imposes fine of 600 marks upon 37 young men, for evading military duty.—May 18.

Germany, Potsdam garrison reviewed by Emperor William and King Humbert.—May 22.

Russia, conspiracy to assassinate Czar discovered among military officers stationed at St. Petersburg.—May 12.

United States, Sunday parades, President Harrison issues proclamation forbidding.—May 21.

Miller Attorney-General, accepts place on Supreme Bench of United States, made vacant by death of Justice Matthews.—May 21.

Millers, The Huron, North Grey, Wellington and Bruce Millers Association hold meeting at Listowel, Ont., and adopt plan of campaign to gain protection.—May 21.

Miners, Brazil, Ind., conference between coal operators and miners, delegation ends with operators' refusal to arbitrate the difference.—May 15.

Miners, Indianapolis, two miners who compose committee of Clay County, miners solicit aid, and state miners in disfavor.—May 24.

Mining, iron, discovered near Guthrie, Oklahoma.—May 30.

Mining Silver, West Beaver Mining Company, share list opens in London, Eng.—May 6.

Missouri Legislature, Australian election law with some modifications adopted by both houses.—May 4.

Mississippi River, party sent out by Minnesota Historical Society to discover source of returns to St. Paul and make report.—May 3.

MORMONS.—Alberta Railway and Coal Company sells to Mormon hierarchy, several thousand acres of land in North-West Territory.—May 23.

From Utah and Idaho, passing through Montana en route to Canada.—May 25.

Morocco, several tribes rebel against Sultan, make prisoners of number of officers.—May 31.

Mura, Princess of, claim indemnity from Italy of 51,000,000 lire for confiscated estate, of King Joachim.—May 31.

MURDERS.—Blair, La., merchant named Melarek shoots his wife, two children and himself.—May 2.

Ballymana, Ireland, Lawlor John H., manager of Ballymana branch of Provincial Bank of Ireland shot dead on road.—May 31.

Baussier, Havre, chemist charged with poisoning his employer acquitted at Rome.—May 25.

Chicago, Dr. P. H. Cronin's body found.—May 22.

Chicago, Cronin Dr., Detective Daniel Coughlin arrested on suspicion May 27.

Chicago, Cronin Dr., P. O. Sullivan and Frank Woodruff indicated.—May 28.

Chicago, Cronin Dr., *Times* says Patrick O'Sullivan makes full confession and gives names of those concerned.—May 23.

Chicago, Cronin case, man named Mack supposed to be driver of the white horse, arrested.—May 31.

Chicago, Cronin Dr., clothes of murdered man found.—May 31.

Cincinnati, Blane A. J., chemist, shoots wife, daughter and himself.—May 12.

Costa Rica, Hobbs Rev. Mr., Baptist minister, wife and child, living on Peand of Ruatan, murdered, shipwrecked sailor from Jamaica arrested.—May 20.

Galveston, Tex., Weyer Judge Henry, J. P., of Galveston county, W. T. Allen and Charles Janeman arrested for murder of Richard Fleischig in 1884.—May 28.

Indianapolis, Shroden John, grocer and saloon keeper, cuts his wife's and his own throat.—May 15.

Jefferson, Allen Mrs. Sarah E., shot by her husband who kills himself.—May 17.

Liverpool, Maybrich Mrs., arrested on charge of poisoning her husband with arsenic.—May 18.

Liverpool, Maybrich Mr., inquest on commences.—May 28.

Maidstone, Ont., Thomas Johnson (colored) arrested at Windsor with beating his child May Johnson to death.—May 21.

Memphis, Tenn., Ward George, shoots and kills his wife and himself.—May 13.

Mountain Home, Pa., Sophia Everett, aged eleven, killed by Jeffrey Harrison, aged eleven.—May 7.

Ozark, Mo., Bill Walker, Dave Walker and John Matthews, the three bald knobbers, executed for murder of Charles Green and William Edens in March, 1887.—May 10.

Rainy River, Man., Humphrey Keller, found murdered near Rapid River.—May 21.

Sillery, P. Q., body of unknown man murdered, found at Bridgewater cove.—May 23.

Springfield, Mass., Smith James Beche, local editor of *Republican*, shot by his brother-in-law Royal B. Sturtevant.—May 13.

Toronto, Charlton Lily, by abortion, John O. Woods arrested a Buffalo.—May 9.

Victoria, B. C., Chinese girl in a house of prostitution murdered by her lover.—May 12.

Washington, Nelson Colbert, hanged for murder of Philip Wentzell.—May 17.

Murphy Mr. Edward, of Montreal, appointed senator for division of Victoria Canada.—May 30.

National Liberal Club, London, Eng., annual meeting of.—May 7.

National Liberal Club, Farnell Mr. C. S., elected a life member.—May 7.

- NAVAL.**—Great Britain, Naval defence bill passes its second reading in House of Commons.—May 7.  
British bill passes Committee stage in Commons.—May 13.  
British, Commander of flagship "Swiftsure" dies at Esquimaux.—May 20.  
British, Naval defence bill passes third reading in Commons.—May 20.  
British man-of-war "Surprise" runs ashore at Syracuse after colliding with and sinking the steamer "Nesta."—May 23.  
British flagships Swiftsure and Amphion sent to Sitka with orders to cruise in Behring sea.—May 27.  
British man of war "Surprise" floated off Island of Syracuse.—May 27.  
Defences bill passes second reading in British House of Lords.—May 27.  
France, Prince George of Greece joins French Navy.—May 21.  
United States, Farquhar Captain, of the "Trenton," arrives at San Francisco from Samoa with shipwrecked sailors, and sends despatch to Secretary of Navy.—May 20.  
United States, warship "Charleston," arrives at San Francisco from Santa Barbara, naval officers report as the "Charleston."—May 13.  
United States, private trial trip of new Government gunboat "Petrol" built by Columbian Iron Works at Baltimore.—May 9.  
United States steamship "Thetis" sails from Tacoma, W. T., for Sitka, Alaska.—May 28.  
United States revenue cutter "Rush" leaves San Francisco for Behring sea.—May 20.  
United States secretary Windom, signs the sailing orders of the revenue steamer "Bear" designated to assist in protecting the Alaskan seal fisheries.—May 31.  
New Brunswick Cabinet, result of meeting of the Government and of the party caucuses.—May 4.  
New Brunswick, N. J., fight between railway men and brickmakers at Sawyerville brickyards, two men killed, several injured.—May 4.  
Newfoundland lobster fisheries, British Government State in House of Commons, they will support British subjects, provided they do not interfere with French treaty rates.—May 7.  
Newfoundland, riot feared in consequence of British resident, being prohibited from setting their nets in best fishing grounds.—May 21.  
New South Wales, Sydney, Dillon, Deasy and Esmonde, Irish Home Rule advocates, arrive at.—May 11.  
New York Fire Department, Hugh Bonner appointed chief.—May 21.  
New York legislature, adjournment of.—May 17.  
Noble Hon. Gay C., prominent lawyer of Vermont, dies at St. Albans.—May 21.  
Nyassa, Southern Lake deputation of missionaries waits upon Lord Salisbury, protesting against surrender of, to Portugal.—May 17.  
O'Brien, William, M. P., declines to testify before Lord Aberdare's committee on prison rules.—May 29.  
Oil Exchanges, Pittsburg, Pa., conference committee meet and decide to recommend dealings in future.—May 7.  
Oklahoma, Guthrie Mayor, prevented by mob from laying out proposed streets.—May 2.  
Omaha Town Site Company, action by Robert Shields, decided in his favor by United States Supreme Court, damages \$22,000,000.—May 23.  
Orange, Grand Lodge of British North America, Goderich, Ont., opening of session at.—May 28.  
Oregon and Trans-Continental Companies, Judge Barrett temporarily enjoins the company from issuing ten millions of new stock.—May 13.  
Oregon and Trans-Continental Company restrained at Portland, Oregon, from issuing new preferred stock.—May 17.  
Oshima Island, Volcanic eruption destroys more than half the houses on the island.—April 13, reported May 29.  
Panama Canal, bonds issue of abandoned.—May 25.  
Paris, count and countess de, Silver wedding of, celebrated at Slean House, Eng.—May 30.  
Paris Exhibition, three men arrested for shouting "Vive Boulanger."—May 6.  
Paraguay and Bolivia, conflict imminent, Brazil preparing to aid Paraguay.—May 13.  
Parnell Mr. C. S., elected life member of National Liberal Club.—May 7.  
Parnell Mr. C. S., Edinburgh Municipal council, confirms resolution granting freedom of city.—May 8.  
Parnell Mr. C. S., M.P., presented at London with address, by deputation from Irish municipalities, congratulating him on disproving the calumnies.—May 23.
- PARNELL TIMES.**—Commission examination of Mr. Parnell concluded.—May 1.  
Commission, Parnell's cross-examination, as to his denunciation of outrages.—May 2.  
Commission, cross-examination of Parnell, as to his dealings with William O'Brien.—May 3.  
Commission, Parnell admits deliberate misstatement of facts, to House of Commons.—May 3.  
Commission, Parnell makes personal explanation as to his admission to deceive House of Commons.—May 7.  
Commission, close of Parnell's cross-examination.—May 7.  
Commission, Walsh Archbishop, goes in the box.—May 8.  
Commission, Father Egan gives evidence.—May 15.  
Commission, Mr. Harrington intimated by secretary, steps will be taken to force him to pay fine of £500.—May 17.  
Commission, O'Brien William, gives evidence.—May 21.  
Commission, O'Brien William, M.P., cross-examined.—May 22.  
Commission, the missing land league books announced to be in possession of a *Times* witness.—May 23.  
Commission, Biggar Mr. M. P. in the box.—May 29.  
Commission, Arthur O'Connor, M. P., gives evidence.—May 30.  
Commission, Mr. O'Connor, M. P. Mr. Justin McCarthy, M. P., and Mr. George Lewis give evidence.—May 30.  
Label suit on application of defendant's suit postponed until November.—May 30.  
Peace movement of Christian churches against militarism, London, Eng., demonstration at St. James' Hall.—May 19.  
Pelham George B., architect of Government Buildings, Ottawa, death of at New York.—May 2.  
Persia, Renter Baron, obtains concessions from National Bank of Persia and to work the coal and other mines.—May 8.  
Persia, Shah, of, leaves Teheran for Russia.—May 12.  
Persia Shah of, arrives at St. Petersburg.—May 23.  
Philadelphia, Insane hospital, warrant issued for arrest of keepers Devlin and William, for assault and battery upon patients.—May 22.  
Pittsburg, Pa., floods do great damage and cause loss of life.—May 11.  
Pope declines to nominate Polish and Russian bishops at Consistory.—May 18.  
Pope in allocation protests against Italian legislation, denounces proposed monument of Gregory Bruna, and refers to recent Catholic congress.—May 24.  
Portugal, Oporto, dynamite bomb exploded at door of civil governor's house.—May 25.  
Postal, Chicago, Post office vault entered and 86 registered letters stolen.—May 26.  
Prison rules, Lord Aberdare's Committee on, William O'Brien, M. P. declines to testify before.—May 29.  
**RAILWAYS,** Canadian Pacific, annual meeting of, at Montreal.—May 8.  
Boston, freight handlers in Firebrick railroad yards decide to demand increase in wages.—May 22.  
Canadian Pacific, new line through Maine wilderness, Lebois to Brownville, Pioneer train stopped by enterpillars.—May 19.  
Canadian Pacific, hearing of Connee and MacLennan suit against, at Coburg, Ont.—May 20.  
Canadian Pacific applies to treasury department, at Washington, to be bonded a common carrier between ports of United States.—May 24.  
Canadian, investigated by United States Committee on Canadian relations.—May 25.  
Cagnecoet ship railway, plans of work submitted by engineer and others to government at Ottawa.—May 30.  
Chicago and Atlantic, Volney C. Malott, appointed receiver.—May 18.  
Cleveland, St. Louis and Kansas road, construction work comes to a standstill by failures of contractors to meet obligations to sub-contractors.—May 13.  
Conductors, twenty-first annual convention opened at Denver, Col.—May 14.  
Delaware, Lackawanna and Western Railway Co., action brought against, by Isaac B. Felts, to recover possession of coal lands in Scranton, Pa.—May 2.  
Eric road cuts the local rate on corn from Buffalo to New York.—May 10.  
Herford railway troubles, John P. Noyes, Q.C., appointed by Quebec Government commissioner to enquire into.—May 2.  
Iron Ore freights, Western agents decide to reduce rate on iron ore from Lake Port to Pittsburg.—May 23.  
Northern Pacific complete arrangements for operating the Wisconsin Central on a traffic agreement.—May 2.

## RAILWAYS.—Continued.

New York, Ontario and Western Railroad Company issues bonds for \$100,000,000 secured by a mortgage to the Mercantile Trust Company.—May 27.

Omaha Railroad Co. completes arrangement with Oregon Railway Navigation Company to connect the two lines.—May 29.

Pennsylvania railway directors decide to issue nearly \$7,000,000 of new stock.—May 8.

Pitston, Pa., railroad and coal companies order their men to resume work on full time.—May 21.

Prussia, freight rates on all lines reduced by Government, to alleviate distress arising from dearth of coal.—May 18.

Regina and Long Lake railroad, arrangements completed in England for building.—May 16.

Richmond and Inverness, Municipal Council of Inverness, N.S., votes \$100,000 bonus towards construction of.—May 2.

Rock Island gives notice, it would meet rates of Chicago, Burlington and Northern between Chicago and St. Paul.—May 31.

Siberian Railway scheme, approved by Russian special commission.—May 2.

Southern Pacific, Annual report of issues for 1888.—May 29.

Union Pacific Co., President Harrison appoints John F. Plummer, George E. Leighton, Jesse Smallding and Rufus B. Bullock to be Government directors.—May 14.

U. S. Board of Railway Commissioners, decide that Central Hudson cease the discrimination in favor of certain firms in Rochester and against firms in Buffalo engaged in produce business.—May 27.

Wabash railway, east of Mississippi river, sold at Chicago to agents of Wabash Western Purchasing Committee.—May 15.

Western Railroad and Board of Trade, Interstate commerce commission resumes hearing at Chicago.—May 28.

Reed Andrew, inspector general of Royal Irish Constabulary, made a knight.—May 24.

Reid Whitelaw, farewell dinner at New York, from gentlemen connected with *Tribune*.—May 3.

Reuter Baron, obtains concession from National Bank of Persia to issue, bank notes for twice the amount of Bank's capital.—May 8.

Rice Mr. Allen Thorndike, newly appointed U. S. Minister to Russia, death of, at New York.—May 16.

Richmond, Agricultural Society, Spring Horse show opens.—May 22.

Rochefort Henri, and Pilotel the artist, fracas between, in Regent street, London.—May 19.

Rogers Major A. B., discoverer of Kicking Horse Pass, death of, at Waterville, Minn.—May 5.

Royal College of Music, London, Eng., Samson Fox donates £45,000 to.—May 22.

Royal Society of Canada, final business meeting.—May 9.

Royal Society of Canada, opening of week's meeting.—May 7.

RUSSIA, St. Petersburg, arrest of officers connected with peaceful political revolutionary society.—May 2.

St. Petersburg, conspiracy to assassinate the Czar discovered among military officers.—May 12.

Siberian Railway scheme, approved by special commission.—May 2.

Conversion loan, Rothschild's arranged for in conjunction with the Disconto Gesellschaft group.—May 11.

Czar issues ukase, placing on the market second series of 310,438,000 gold roubles four per cent. consolidated railway bonds.—May 14.

Large number of arrests made at St. Petersburg, Moscow and Cronstadt.—May 13-16.

Ignatieff Gen., appointed Assistant Minister of Interior.—May 27.

Odesa, two enormous bombs found beneath streets alongside which Royal visitors usually pass on their way to the palace.—May 27.

Ryan Hon. Thomas, death of, at Montreal.—May 25.

Ryerson Rev. Egerton, founder of school system of Toronto, unveiling statue of, at Toronto.—May 24.

Saliubay Lord, speaks at meeting of Primrose League, London, Eng., and says alliance between Parnellites and Gladstonians slowly breaking.—May 21.

Salt, English Salt Union, Wellington Burt of Michigan and Chas. Burger of New York, on behalf of American merchants enter into an alliance with.—May 23.

SAMOA, Knappe Dr., late German consul, arrives at Sydney, N. S. W. with latest news.—May 5.

Conference, Prince Bismarck gives an audience to commissioners who desire neutrality of the Islands.—May 7.

Farquhar Captain, of the "Trenton" arrives at San Francisco with shipwrecked sailors from Samoa, and sends despatch to Secretary of Navy.—May 20.

Conference, Germany accedes to demands of United States commissioners to restore King Malietoa.—May 21.

## SAMOA.—Continued.

Conference at Berlin comes to agreement upon all the questions at issue.—May 22.

Admiral Kimberley succeeds in stopping hostilities for the time being Mataafa and Tamaeae agree to truce pending conference at Berlin, reported May 27.

Admiral Kimberley reports to U. S. navy department that natives disbanding and peace prevails.—May 27.

Conference, Sir E. Malet, Mr. Ranson and Herr Hulstein complete draft of protocol.—May 27.

Conference commissioners agree to questions at issue and draw up a protocol.—May 31.

Saxony, Koenigstein, powder magazine struck by lightning, and explodes.—May 16.

Schleswig, authorities of, refuse to rescind decree expelling certain German-Americans from the Islands of Amroon and Fohn in the North Sea.—May 4.

Scott Act, counties of Oxford, Lambton and Middlesex reject the measure.—May 9.

Scotch, Irish congress at Columbia, Tenn., adopt plan for permanent organization of Scotch-Irish of America, and elect Robert Bonner, President.—May 9.

Scotch local government bill read second time in British House of Commons.—May 30.

Sea Serpent, Philadelphia, Capt Smith, of Steamer "British Princess" from Liverpool, reports seeing monster on May 4 in lot 44, long 42, 40.—Reported May 14.

Servia, Pan Servian plot discovered at Bosnia, numerous Russian intriguers arrested.—May 24.

Shanty-men, Algoma, riot among, at North Bay, three men killed, traveller arrives in Toronto and gives particulars.—May 3.

SHIPPING, "City of New York" arrives at Queenstown, making the quickest passage on record from New York.—May 8.

Belleisle, straits of, Quebec Board of Trade decides that no sailing vessel should pass by the straits before first of July.—May 27.

Boston, Captain Josiah Lawlor with Hans Hansen sail for France in schooner "Never Sink," 36 feet long.—May 29.

British Steamer "German Emperor" from London for Bilbao ran into British steamer "Beresford" from Hartlepool for Bombay on Goodwin sands, thirty persons drowned.—May 29.

British ship "Attimore" from Sydney, N.S. W., for San Francisco, wrecked at Neral in the South Pacific.—Reported May 15.

British steamship "Aberlady" strands near Cape Lookout, N. C., crew saved.—May 13.

Canada, order-in-council passed as to fees to be exacted from all vessels navigating inland waters of Canada, when entering on clearing at any port above Montreal.—May 24.

Cleveland, Ohio, master of schooner "Sophia Minch" fined for employing alien on board as officer.—May 18.

Cunard Steamship Company and Oceanic Steam Navigation Company secure contracts to carry the outward British mails.—May 31.

Halifax, N.S., Canadian cruiser "Vigilant" seizes Gloucester schooner "Mattie Winship" about two miles off Cape North, C.B.—May 31.

Hamburg, American steamer "Rugia" from New York, cargo of cotton takes fire.—May 8.

Hamburg-American line's new turn screw steamer arrives at Hamburg from her trial trip.—May 7.

Lake Ontario, three barges laden with lumber ashore at Point Peter light.—May 28.

Lake Ontario, "Bavaria" ashore at Gallos Islands all lives supposed to be lost.—May 29.

Liverpool, Steamer "Servia" arrives with cargo on fire.—May 28.

Liverpool steamer "Eunland" from New Orleans arrives with cargo of cotton on fire.—May 22.

Magdalen Islands, Dutch whaler broken into pieces by storm.—May 19.

Missouri steamer arrives in London, great oration given Captain Murrell.—May 18.

Montreal, Steamship "Cynthia" from Glasgow sunk by S. S. "Polynesian" of Longue Pointe, eight of the crew drowned.—May 22.

Newfoundland coast, two French fishing vessels, the "Elia" and "Quatre Frères," lost with 175 men.—Reported May 21.

Owen Sound, new steel steamship "Maaitoba" constructed for Canadian Pacific Railway, launch of.—May 4.

"Parkhurst" London steamer arrives at Rio de Janeiro with cargo on fire. News brought to Queenstown by Inman liner "City of New York."—May 29.

## SHIPPING.—Continued.

Queenstown, "City of Paris" arrives after journey of 5 days, 22 hours, 10 minutes.—May 22.

St. Andrews, N. B., sloop sinks off Hardwood Island, six men drowned.—May 4.

Schooner "Willie Parkman" of Portland runs down and sinks fishing schooner "Chimpoon"—May 16.

Steamer "Angusta Victoria" of Hamburg Packet line arrives at New York, making the fastest trip ever made across the Atlantic.—May 18.

Steamship "Escalona" from Mediterranean ports goes ashore at the Platon, St. Croix Bay, Quebec.—May 20.

Steamship "Alaska" bound to San Francisco from Puget Sound, wrecked off Astoria, Oregon.—Reported May 16.

Steamer "City of Paris" arrives at New York from Liverpool, having made quickest passage on record.—May 8.

St. Lawrence Canals, instructions issued at Ottawa as to Saturday and Sunday opening and closing hours.—May 30.

Syracuse, British man-of-war "Surprise" runs ashore after colliding with and sinking steamer "Nesta"—May 26.

Suez Canal, British steamer "Carlew" from Swansea runs into and sinks British steamer "Nyaza" from Cardiff.—May 23.

Sioux reservation lands in Dakota, great boom of.—May 14.

Smallpox, Guatemala, epidemic at.—May 27.

Smallpox, Nanticoke, Pa., twenty persons ill with.—May 22.

Smallpox, Soudan, Capt. Wessman's contingent, smallpox broken out among.—May 31.

Smith Professor Goldwin, addresses Board of Associated Charities at Toronto.—May 20.

Smythe Bishop, Portuguese authorities, on demand by British Foreign office cease to obstruct passage of the Bishop and party on way to Luanda, Nyassa by way of Mozambique.—May 21.

Smuggling, Calhao, goods valued at \$100,000 and other smaller lots seized.—May 24.

Smuggling, St. Thomas, P. Q., schooner "Mary Ann" seized by customs officials for smuggling whisky.—May 11.

Socialism, France, Narbonne municipal election results in victory for socialists.—May 12.

Socialism, Holland, The Hague, body of laws down royal standard from great tower and twists socialist flag.—May 12.

Socialists, Austria, Government warned by Germany to, that German Socialists agitating among Austrian miners.—May 27.

Socialist, Mons, house of one of the jymmen in the trial of alleged Socialists damaged by explosion of dynamite cartridge.—May 25.

South Africa, Company to apply for royal charter to administer to all unappropriated Central and South Africa.—May 29.

SPAIN.—Chamber of Deputies, Budget presented.—May 2.

Lueca, Anarchist, Republican conspiracy discovered at.—May 18.

The Cortes, Senor Sagasta reads decree of the Queen Regent, suspending session of that body.—May 24.

SPORTS.—Aquatics, Toronto, cablegram received that unless Searle's deposit of £100 with London Sportsman covered by May 10th, race between himself and O'Connor would be declared off.—May 2.

Aquatics, Montreal Canoe Club, annual races at Pointe Claire, P. Q.—May 24.

Aquatics, "Vice Commodore's cup, "The Lulu" wins.—May 25.

Bicycling tournament opens at Chicago.—May 13.

Bowling, Boston team defeated by Worcester.—May 3.

Cock fighting, Kingston, Ont., three principals fined in Police Court.—May 10.

Cricket, Dundas H. A. L., of Calgary, member of Winnipeg Crick Cricket Team, death of.—May 22.

Lacrosse, Huntingdon Lacrosse Club, election of officers.—May 17.

Lacrosse, Montreal, Hawthornes beat Victorias.—May 11.

Lacrosse, Montreal, Montrealers beat Shamrocks by three straight games.—May 25.

Lacrosse, Toronto beat Shamrocks.—May 24.

London, Eng., Yachting, Lord Dunsraven's yacht, the "Valkyrie," sails her maiden match.—May 22.

Racing "Czar," the phenomenal 3 year old running colt, owned by Theodore Winters of California, dies of Pneumonia.—May 13.

Racing, Jockey club warns Lord James Douglas off Newmarket course for defaulting in bets.—May 30.

Racing, Kingston Park, great jubilee stakes won by General Byrne's amphion.—May 10.

Racing, Newmarket, first spring meeting, Two Thousand Guinea stakes.—May 1.

Racing, Newmarket, Eng., One Thousand Guinea stakes—won by Viner's "Nunbe."—May 3.

## SPORTS.—Continued.

Racing, Newmarket stakes, Duke of Portland's Donovan wins.—May 22.

Whinnipeg, Paterson, N. J., Steve Brodie jumps over Paganic Falls.—May 20.

Yachting, Lord Dunsraven objects to New York Yacht Club's reply to his challenge.—May 2.

Yachting, London, Eng., "Valkyrie" beaten by "Irex" and "Yaranna."—May 28.

STANLEY H. M., Royal Geographical Society at London, Sir Francis de Winton, president of Emin Bey relief committee, speaks and predicts early return of Stanley.—May 12.

Steel, Basic process, Hewitt Abraham S., interviewed thereon, at New York by New York *Herald*.—May 14.

Stock Exchange, New York, official announcement made that no more quotations distributed by stock indicators or tickers.—May 31.

Stokes Professor, created a baronet.—May 24.

STRIKES.—Italian laborers on Schuykill and Lehigh Valley Railroad at Cressona, Va.—May 2.

Iron workers, McKeesport, Pa., two thousand employees of welding department of National Tube Works strike for advance of 10 per cent wages.—May 16.

Masons, Berlin, 2,000 masons struck for shorter hours and higher pay.—May 20.

Miners, Austria, 10,000 miners at Saar, Austria, have struck.—May 24.

Miners, Belgium, strike in Seraing district extending.—May 29.

Miners, Germany, 5,000 strikers meet at Bochum, and resolve to insist upon their demands, Council of Ministers, Prince Bismarck presiding, consider the strikes.—May 9.

Miners, Gelsenkirchen West riot, number of shops wrecked.—May 5.

Miners, Gelsenkirchen, Westphalia, miner killed and many persons injured during.—May 5.

Miners, Westphalia, Military in, disturbed, district reinforced, conflict in Essex, 3 men killed and 5 wounded.—May 8.

Miners, Brazil, Int., conference between coal operators and miners delegation ends with operators' refusal to arbitrate the difference.—May 15.

Miners, Germany, miners at Mulheim and Duisberg join in. Delegates at Bochum abandon demand for higher wages, but insist upon reduction of hours. Krupp issues notice protesting against illegal action of miners.—May 10.

Miners, Germany, mines at Dortmund, Essen and Bochum deserted. Krupp and other works compelled to stop manufacture of rails.—May 10.

Miners, Germany serious conflicts between troops and strikers.—May 11 and 12.

Mining, Germany, coal mine owner and striking miners appoint committee to confer and arrange settlement of dispute.—May 12.

Mining, Germany, pit workers at Margaretha express willingness to resume work on condition that they be protected from strikers.—May 13.

Miners, Germany, Prussian Ministry decides to summon to Berlin deputations from mine owners and miners.—May 13.

Miners, Germany, Emperor Williams receives delegates of striking miners.—May 14.

Miners, Germany, several owners in Essen and Dortmund concede the demands of their employees, and the men resume work.—May 15.

Germany, Builders, Sprottan, Carpenters, Bauschlag, Kornsberg, Waryburg and Lubek, Brewers Dortmund.—May 16.

Germany, Emperor, receives deputation of Westphalian mine owners, who present their side of mining troubles.—May 16.

Miners, Germany, miners delegation report to strikers at Dortmund result of their visit to Berlin, proposed compromise approved.—May 17.

Miners, Germany, several owners grant the advance in wages demanded.—May 18.

Miners, Germany, strikers agree to return to work, but threaten to strike again if owners fail to keep their promises.—May 20.

Miners, Germany, strikers in Dortmund, Bochum and Essen districts resume work.—May 21.

Miners, Germany, in consequence of non acceptance by owners of strikers terms, Gelsenkirchen miners resolve to continue the strike.—May 22.

Miners, Germany, Mass meeting attended by 1,000 persons held at Boston in sympathy with strikers.—May 24.

Miners, Germany, colliers still show tendency to hold out, declaring employers do not hold to their promises.—May 24.

Miners, Germany, miners of Essen resume work.—May 25.

Miners, Germany, all meetings of miners prohibited by Government. May 27.

## STRIKES.—Continued.

Miners, Germany, arrest of members of committee appointed to represent striking miners at Bochum.—May 27.

Miners, Germany, strikers at Pilsen assume threatening attitude, troops ordered there to preserve order.—May 28.

Miners, Germany, strikers at Essen, Bochum and Dortmund, hold meetings and decide to resume work.—May 29.

Miners, Germany, homes of leaders of strike at Dortmund, raided by police and letters and money seized.—May 29.

Miners, Hatfield, Ill., Gov. Pifer, authorizes Illinois National Guard to protect property and persons endangered by riot.—May 27.

Miners, Stantonville, Ill., Sheriff Henderson telegraphs for re-inforcements as not anticipated.—May 24.

Miners, Silesia, rioting and pits demolished.—May 17.

Miners, Spain, delegation from German strikers committee visiting all the chief towns in Spain.—May 29.

Miners, Westphalia, encounter near Bracket between the troops and strikers, 3 miners killed, several wounded.—May 10.

Miners, Westphalia, Herr Weber, president of Bockum strikers committee, arrested for making an inflammatory speech.—May 24.

Miners, Westphalia pitmen resume work.—May 31.

Miners, Yorkshire miners threaten to strike unless employers concede an advance in wages.—May 13.

Omnibus drivers, Rome, Italy.—May 27.

Peasants, Milan, conflict between strikers and military, one peasant killed and eight injured.—May 20.

Plasterers laborers, Toronto, demand an increase of two and a half cents an hour, and go out on strike.—May 18.

Railroad Coal Miners, Pittsburg district, compromised.—May 14.

Shipping employees, Allan and Anchor lines yield to demand of strikers.—May 11.

Street Car Drivers, Prague, Company yields to demand of employees.—May 10.

Shipping firemen, Liverpool Steamer "City of Chicago" detained in consequence.—May 8.

Steel Workers, Alleghany, Va., works carried on by non-union men, number of rails turned out.—May 6.

Street Car drivers, St. Paul, Minn., men agree to go back to work on reduced wages.—May 3.

Tramcar employees, Prague, company fined by municipal authorities £1,000 for cessation of traffic caused by the strike.—May 27.

Tramway drivers, Prague, lines at a standstill.—May 24.

Women employed in rice fields, at Mediana, Italy, bakers shops pillaged, troops called out.—May 21.

Suez Canal, directors recommend annual dividend for 1889 of 38 per cent.—May 22.

Sugar Bounties and United States, government discussion in British House of Commons.—May 10.

Sugar Merchants, Trieste, conference of Austria and Hungarian merchants, resolutions adopted urging Government to withdraw from London sugar bounties convention.—May 16.

SUICIDE.—Dallas, Tex., Rice Mrs., kills herself with strychnine.—May 3.

Ottawa, Sherwood Mr. Edward, ex-deputy sheriff of the county of Carlton, shoots himself.—May 11.

Baltimore, Schorr Rev. H. G., assistant rector of St. Paul's Episcopal Church, shoots himself.—May 27.

St. Vincent de Paul, P. Q., Louis Lahaie, a convict, hangs himself.—May 4.

Sinvarrow Islands, commander of British cruiser "Rapid" hoists British flag over.—May 8.

Siam, war renewed between the Dutch and Malays, natives attack the port of Achen, but are repulsed with loss of 160 killed.—May 15.

Swiss confederation, executive council of Berne forbids exhibitions of hypnotism.—May 20.

Switzerland, German Booksellers, arrested at Zurich, against whom false information had been given by Socialists.—May 31.

Switzerland, Spiesback, land slide destroying villages, forests and cattle.—May 15.

Switzerland, Bundesrath order expulsion of Russian suspected of making bombs in Zurich.—May 7.

Tea, U. S. Consul Crowell at Amoi, China, reports as to tea from Amoi Oulong.—May 7.

TELEGRAPHS.—Canadian Pacific Railway vs. Western Union Telegraph Company, argument heard before Supreme Court at Ottawa.—May 8.

Halifax, Bermuda cable, copy of contract presented to British House of Commons.—May 7.

Halifax, Bermuda, cable contract for, approved by British House of Commons.—May 10.

## TELEGRAPHS.—Continued.

Halifax, Bermuda Cable Co., issuing £120,000 sterling 4 per cent. debentures.—May 28.

New York, Western Union and Postal Telegraph Companies, order issued reducing long distance rates, and slightly advancing short distance rates.—May 3.

Tennyson Lord, starts on cruise in Lord Brassey's yacht "Sunbeam."—May 23.

THEATRICAL.—Easton, Pa., Lotta has a fall on the stage of the Opera House.—May 3.

Jersey City, Academy of Music catches fire.—May 11.

London, Eng., Opera Comique, Massenet's new opera "Esclamonde" produced.—May 16.

New York, Fanny Davenport married to Melbourne McDowell, leading man in her dramatic company.—May 19.

Toronto, Edward Stowe of New Orleans, one of the members of Haverley-Cleveland minstrel troupe, playing at "The Grand," shoots at Cleveland, the manager.—May 24.

Watson Mrs. Charles T., death of, in New York.—May 4.

Worcester, Mass., Theatre destroyed by fire.—May 16.

Tolstol Count, Russian Minister of the Interior, death of.—May 7.

Toronto Board of Grain examiners and Arbitrators, Order in Council passed limiting powers of.—May 29.

Toronto University, Senate meeting of and conferment of Honorary degrees.—May 27.

Trance, Boston, Patton Miss Kate, taken for dead, and preparations being made for funeral.—May 21.

TRUSTS.—Copper, failure of the conference despatch from Paris to Boston *Herald*.—May 4.

Flour, English Syndicate attempting to purchase great flour mills of America.—May 22.

Meat, American Meat Company, and America cattle trust, make contract, by which the former will handle entire produce of cattle trust.—May 18.

Omaha, Chicago live stock pool breaks.—May 7.

Turkey, Armenian Village attacked by Kurdish Chief, prominent men seized and burned to death with petroleum, despatch dated.—May 6.

Turkey, Montenegrin frontier, Christians reported to be massacred by Turks.—May 17.

Turkey, Sultan sends envoy to Berlin to thank Emperor William for his support of Turkey's Eastern policy.—May 11.

Universal Peace Union, New York, twenty-third anniversary opened.—May 13.

UNITED STATES.—Senate Committee on trade relations with Canada leave Chicago for San Francisco.—May 2.

Senate Commission on trade relations with Canada arrives at Los Angeles, Cal.—May 14.

Senate Committee on Canadian relations commences investigation at Tacoma, W.T.—May 25.

Senate committee on Canada arrive at Victoria, B.C.—May 27.

Senate Committee on Canada arrive at Seattle, W. T., and hold session.—May 29.

University Federation, Toronto, an injunction served to restrain the Federation of Victoria College to Toronto University.—May 2.

Victoria University, senate of, meets at Coburg, and considers federation with Toronto University.—May 11.

Volcanic eruption, Oshima Island, half the houses destroyed.—April 13, reported May 29.

Voodooism, Louisiana, arrest of white and negro men and women.—May 29.

Warsaw, N. C., struck by Cyclone, considerable damage done.—May 2.

Watson Mrs. Charles T., reader and actress, death of, in New York.—May 4.

West Beaver Silver Mining Company, share list opens in London, Eng.—May 6.

White Caps, Mount Auburn, Ia., Farmer's barn burned down, several persons fatally injured.—May 30.

Wiman Mr. Erastus, speaks on Commercial Union at Harmony Hall, Ottawa.—May 4.

Wiman Erastus, the Dominion Statistician at Ottawa answers some of Mr. Wiman's statements.—May 7.

Window Glass Workers Association issues order that all foreign glass workers coming from the United States be blacklisted.—May 10.

Windspe, McMillan Col., appointed to succeed Treasurer Jones.—May 6.

Wurtemberg King of, insists upon return of Baron Savage, his American advisor.—May 2.



Wurtemberg, Emperor William writes to King Charles, advising him not to permit the return of Baron Savaige, his American favorite.—May 15.

WRECKS. Astoria, Oregon, steamship "Alaska" bound to San Francisco from Puget Sound.—Reported May 10.

Cape Lookout, N. C., British steamship "Aberlady" strands near, crew saved.—May 13.

Goodwin Sands, British steamer "German Emperor," from London for Ribboa, ran into the British steamer "Beresford" from Hartley-pool for Bombay, thirty persons drowned.—May 20.

Lake Ontario, three barges laden with lumber, ashore at Point Peter light.—May 28.

Lake Ontario, "Bavaria" ashore at Gallos Islands all lives supposed to be lost.—May 29.

Magdalen Islands, Dutch whaler broken into pieces by storm.—May 19.

Montreal, steamer "Cynthia" sunk by steamer "Polynesian" off Longue Pointe, 8 lives lost.—May 22.

WRECKS.—Continued.

Neira in South Pacific, British ship "Attmore" from Sydney to Sao Francisco.—Reported May 15.

Newfoundland, two French fishing vessels, the "Ella" and "Quatre Frères," lost with 175 men.—Reported May 21.

Platon, St. Croix Bay, Quebec, steamship "Escalona," from Mediterranean ports, goes ashore.—May 20.

Suez Canal, British steamer "Nyuntza" from Cardiff sunk by British steamer "Curfew," from Swansea.—May 23.

Wright William, LL.D., professor of Arabic in University of Cambridge death of.—May 23.

Young Men's Christian Association, Orange, N.J., annual conference at.—May 2.

Young Men's Christian Association, Philadelphia, 28th international convention opens.—May 8.

Zetland, Earl of, appointed Lord Lieutenant of Ireland.—May 29.

  
 WHEN  
 YOU \* ARE \* READY  
 To order any more  
**BINDING**  
**PLEASE CALL UP**  
**TELEPHONE \* 230**  
 Or send a POSTAL CARD to  
**JOHN LOVELL & SON,**  
 23 & 25 St. Nicholas St., Montreal  
 Best work at moderate price.  

Photo - Engraving.

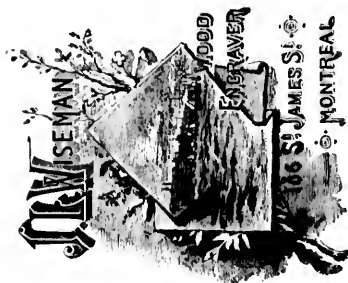

Pen Drawing & Map Etching.



**ALBEMARLE HOTEL.**

EUROPEAN PLAN,  
Broadway, Fifth-ave. & 24th-st., New York.  
(MADISON SQUARE.)  
JANVRIN & WALTER, Proprietors.

**HOTEL KAATERSKILL,**

Catskill Mountains, New York,  
Largest and Finest Mountain Hotel in the world. Rates of board moderate.  
W. F. PAIGE, Manager.  
Kaaterskill P.O., Greene Co., New York.

**WEST END HOTEL,**

LONG BRANCH,  
SEASON OF 1889.  
Cottages and Restaurant open Saturday, June 8th. Hotel opens June 22nd,  
with improvements and additional attractions.  
D. M. & W. E. HILDRETH, Props.

**ASTOR HOUSE,**

Broadway, New York.  
On the European Plan. Rooms \$1.00 and Upwards.  
The accommodations of the Astor will be found first-class in every respect.  
Elevator running night and day.  
F. T. KEITH, Manager. F. J. ALLEN, Proprietor.

**"THE BATES,"**

INDIANAPOLIS, IND.  
Rates, \$2.50 to \$5.00 per day.

LOUIS REIBOLD, Proprietor.

**PARKER HOUSE,**

BOSTON.  
European Plan. 300 Rooms. \$1.00 and Upwards per day.  
Café of unsurpassed excellence. Private dining rooms for dinner parties.  
E. O. PUNCHAARD & CO., Proprietors.

**TREMONT HOUSE,**

CHICAGO.  
THE "PALACE" HOTEL.  
JOHN A. RICE & CO.  
Prices, \$3.00 to \$5.00 per day. Special rates made by the week. Rooms  
single or en suite, with or without baths.  
MRS. JOHN A. RICE, Manager.

**ALBION HOTEL,**

MARKET SQUARE, - - - TORONTO.  
The best dollar a day house on the continent. Fine rooms; good service  
every convenience. Centrally located for railways, steamboats and street  
cars.  
JOHN HOLDERNESS, Proprietor.

**THE PALMER HOUSE,**

TORONTO.  
Corner King and York streets. Specially adapted for Commercial men.  
\$2.00 per day.  
J. C. PALMER, Proprietor.  
Also Kerby House, Brantford.

**ST. NICHOLAS HOTEL,**

EDWARD N. ROTH,  
CINCINNATI, OHIO.  
On the European plan. Location and service unsurpassed. Every modern  
improvement. Rooms, \$1.50 per day and upwards.

**GRAND UNION HOTEL,**

Opposite Grand Central Depot,  
NEW YORK.  
Six hundred rooms at \$1 a day and upwards. Restaurants at moderate prices.  
BAGGAGE TO AND FROM GRAND CENTRAL DEPOT FREE.  
W. D. GARRISON, Manager.

**GRAND HOTEL,**

Broadway, cor. 31st-st., New York.  
ON THE EUROPEAN PLAN.  
HENRY MILFORD SMITH & SON, Props.

**THE GRISWOLD,**

DETROIT, MICH.  
Located corner Griswold and Congress-streets. Newly furnished and refitted  
throughout.  
Rates, \$2 per Day.  
ALBERT MANWELL, Proprietor. E. T. OSBORN, Manager

**FOREST CITY HOUSE,**

CLEVELAND, OHIO.  
Best location in the city, and the only hotel fronting on the park. Nearest  
to public buildings, opera house, churches, etc. Street cars pass the house to  
all parts of the city, suburbs and depots. Rates, \$2.50 and \$3 per day.  
TERRILL & INGERSOLL, Proprietors.

**FIFTH AVENUE HOTEL,**

Madison Square, New York.  
The largest, best appointed and most liberally managed hotel in the city,  
with the most delightful and central location. Conducted by HITCHCOCK,  
BARLING & CO., who first opened it to the public.

**THE WINDSOR HOTEL,**

DENVER, COLO.  
Largest and most Elegant Hotel in the West.  
BUSH & MORSE, Proprietors.

**ADAMS HOUSE,**

Washington-st., Boston.  
ON THE EUROPEAN PLAN.  
Three hundred rooms. Private parlors, baths, etc. Best location in the  
city. A strictly first-class house.  
GEO. G. HALL, Proprietor.

**YOUNG'S HOTEL,**

On the European Plan,  
Head of State-st., Boston.  
Greatly enlarged and improved, and now offers superior accommodations for  
both ladies and gentlemen. Noted for the peculiar excellence of its cuisine.  
J. B. WHITTLE, Proprietor.

**TOWER HILL HOTEL**

AND COTTAGES.  
NARRAGANSETT PIER, R.I.  
Season 1889 opens June 25th.  
CHARLES A. MAKES, New York Office, 145 Broadway, Room 39.

The Oldest and Largest Roller Casting Estab-  
lishment in New England.

ESTABLISHED 1859

WILD & STEVENS,

MANUFACTURERS OF

Printers' Rollers and Roller Compositions,

No. 148 CONGRESS STREET, BOSTON.

WEBSTER

In various Styles of Binding, with and without  
Patent Index.

The Latest Edition has 118,000 Words, and 3,000 En-  
gravings,—3000 more Words and nearly 2000 more Engravings  
than found in any other American Dictionary. It also contains a  
Biographical Dictionary, giving brief facts concerning nearly  
10,000 Noted Persons. To these features we have

JUST ADDED (1885),  
A NEW PRONOUNCING

Gazetteer of the World,

containing over 25,000 Titles,

briefly describing the Countries, Cities, Towns, and Natural  
Features of every part of the Globe.

WEBSTER IS THE STANDARD

Authority with the U. S. Supreme Court and in the Gov't. Printing Office,  
and is recommended by the State Sup'ts. of Schools in 36 States, and by  
the leading College Presidents of the United States and Canada.

THE LONDON TIMES says: It is the best Dictionary of the Language.  
THE QUARTERLY REVIEW, LONDON, says: It is the best practi-  
cal Dictionary extant.

THE CALCUTTA ENGLISHMAN says: It is the most important  
work of the kind.

THE TORONTO GLOBE, CANADA, says: Its place is in the very  
highest rank.

THE NEW YORK TRIBUNE says: It is recognised as the most useful  
existing "word-book" of the English language all over the world.

It is an invaluable companion in every school, and at every fireside.  
Specimen pages and testimonials sent prepaid on application.

G. & C. MERRIAM & CO., Publishers,  
Springfield, Mass., U.S.A.

## TWO MILLION READERS

are a great many to claim for one publication, but it is undoubtedly true  
that as many read **THE YOUTH'S COMPANION** every week. It has a world  
wide reputation, and is sent all over the globe where the English language  
is spoken or read. The reason for its large circulation is found in its  
exceptionable value. It is always safe, pure, entertaining and instructive.  
Its influence upon growing boys and girls can hardly be over-estimated.  
It is remembered affectionately by their parents who read it a generation  
ago.

The Subscription price of **THE COMPANION** is \$1.75 a year, including the  
four holiday numbers, for Christmas, New Year's, Easter, and Thanksgiving  
all the Illustrated Weekly Supplements, and the Annual Premium List  
with 500 illustrations. Address, **THE YOUTH'S COMPANION**, Boston, Mass.

## PERFECT NEWSPAPER FILE.

The Koch Patent File, for preserving newspapers, Magazines, and  
pamphlets, has been recently improved and price reduced. Subscribers to  
the **SCIENTIFIC AMERICAN** and **SCIENTIFIC AMERICAN SUPPLEMENT** can be  
supplied for the low price of \$1.50 by mail, or \$1.25 at the office of this  
paper. Heavy board sides; inscription "SCIENTIFIC AMERICAN"  
in gilt. Necessary for every one who wishes to preserve the paper. Address  
**MUNN & CO.**, Publishers **SCIENTIFIC AMERICAN**.

## THE SPECIAL FEATURES OF THE YOUTH'S COMPANION

For the year, include **SIX SERIAL STORIES**, and **ONE HUNDRED**  
and **FIFTY SHORT STORIES**, fully illustrated.

ALSO TALES OF ADVENTURES,

ILLUSTRATED SKETCHES OF TRAVEL,

HUMOROUS ARTICLES,

SCIENTIFIC AND HISTORICAL ARTICLES,

HOUSEHOLD ARTICLES,

One Thousand Anecdotes, timely Editorials on the leading questions  
of the day, and a whole page each week for the little ones.

## THE COMPANION

has won a place in the home life obtained by no other paper, and is read  
every week in nearly half a Million families. With its Double Holiday  
Numbers at Thanksgiving, Christmas, New Year's and Easter, its Weekly  
Illustrated Supplements, its fine paper and beautiful pictures, no other  
weekly literary paper can approach it in value. It is really a \$2.50 paper  
for only \$1.75 a year.

Every subscriber receives the Supplements and Double  
Holiday Numbers, and the Annual Premium List with 500  
Illustrations. Address,

THE YOUTH'S COMPANION,  
BOSTON, MASS.

WHO SUBSCRIBE TO THE

## "INDEX OF CURRENT EVENTS."

The "Index of Current Events" is much appreciated not only by the press of Canada and the United States, but also by the public men of both countries. Its list of subscribers includes such great newspapers as the Philadelphia *Ledger*, the Boston *Transcript*, the New York *World*, the Cincinnati *Enquirer*, the Brooklyn *Eagle*, the Toronto *Empire*, the Cleveland *Leader*, the Chicago *Herald*, the Cincinnati *Post*, the New York *Morning Journal*, the Chicago *Daily News*, the Indianapolis *Journal*, the New York *Star*, the Troy *Budget*, the Chicago *Staats Zeitung*, the New York *Nation*, the Troy *Press*, the Washington *Star*, the Chicago *Inter-Ocean*, and many less known but important newspapers. Some of these papers are well known to keep admirable indexes of their own, yet find it advantageous to subscribe to the INDEX OF CURRENT EVENTS. We have the honor to include among our subscribers, Her Majesty's Privy Council for Canada; also, Sir John Macdonald, G. C. B. Premier of the Dominion, Sir Hector Langevin, Minister of Public Works, Sir A. P. Caron, Minister of Militia, the Hon. G. E. Foster, Minister of Finance, the Hon. Mackenzie Bowell, Minister of Customs, the Hon. J. A. Chapleau, Secretary of State, the Hon. John Costigan, Minister of Inland Revenue, the Hon. John Haggart, Postmaster-General, the Hon. John Carling, Minister of Agriculture, the Hon. C. H. Tupper, Minister of Marine and Fisheries, the Hon. Commissioner of Agriculture and Colonization Quebec, the Hon. Boucher de La Bruère, late speaker of the Legislative Council, Quebec, the Hon. Lieutenant Governor Royal, Mr. Erastus Winman, the Hon. Minister of Public Works, Toronto. The Librarian of Parliament, the House of Commons Reading Room and the Librarians of many of the Provinces of the Dominion and States of the Union subscribe to the *Index*. Among the well known public librarians who subscribe are, Mr. J. C. Hurlbut, Librarian of the American Geographical Society, New-York, Mr. W. A. Bardwell, Librarian of the Brooklyn Library, Mr. W. H. Brett, Librarian of the Cleveland Public Library, Mr. F. P. Jordan, Librarian of the Public School Library, Battle Creek, Michigan, Mr. W. T. Peoples, Librarian of the Mercantile Library, New-York, Mr. Robert E. Rich, Librarian of the Public Library, Portsmouth, N.

H., Mr. J. P. Dunn, Librarian of the Indiana State Library, Indianapolis, Mr. F. W. Vaughan, Librarian of the Social Law Library, Boston, the Librarian of the Philadelphia Library, the Librarian of the Providence Public Library, the Librarian of the Free Public Library, San Francisco, Mr. John M. Doane, State Librarian of Ohio, Mr. William H. Egle, State Librarian of Pennsylvania, Mr. M. Chamberlain, Librarian of the Boston Public Library, and Mr. A. W. Whelpley, Librarian of the Cincinnati Public Library. The leading bankers (including the Bank of Montreal), brokers, lawyers and hotel keepers of Canada, and many clergymen also keep the *Index* on file.

What is thought of the *Index* may be gathered from the numerous entirely unsolicited expressions of approval sent in by well known public men, of which the following are specimens:

MR. MARTIN J. GRIFFIN, LIBRARIAN OF PARLIAMENT, OTTAWA, writes, I am sending you a subscription for two copies of your "*Index*," which will be most useful and which deserves encouragement. If you will take particular pains to give the dates and figures of elections and the dates of speeches of public men, with references also to the place at which the speech was delivered, you will do a very grateful thing for public people and editors, and I may add librarians.

MR. JOHN M. DOANE, STATE LIBRARIAN OF OHIO, writes:—Enclosed please find six dollars, in payment for State Library subscription to the "*Index of Current Events*" for 1889.

I regard it as a very valuable publication, and hope that you may meet with such success as to warrant its continuance, for it will grow more valuable every year.

MR. HERRIES, OF THE BROOKLYN *Eagle*, writes:—"I congratulate you most heartily upon having done a good thing, a very good thing, in starting the "*Index*" enterprise. I hope I may have the joy of congratulating you upon your success a year hence. A man with *Index* on the brain is one after my own heart. My judgment was formed upon Number 1; if the indexing is kept up as thoroughly in all subsequent numbers it will be a great help to us."

SIR CHARLES TUPPER, BART., HIGH COMMISSIONER FOR CANADA, writes:—It seems to me to be a very useful publication, and one that will be valuable for reference purposes."

MR. BURN, ASSOCIATE EDITOR OF THE PHILADELPHIA *Public Ledger* writes:—"Your *Index* is highly appreciated at this office, where it has long been a desideratum."

MR. COLQUHOUN OF THE "TORONTO EMPIRE," writes:—"Allow me to congratulate you most cordially upon your admirable *Index*." The idea and its execution are alike worthy of all praise.

MR. VALEN, OF THE "NEW-YORK MORNING JOURNAL," writes:—"I find the *Indices* of great value, saving, as they do, much valuable time in looking up important events."

MR. WILL A. WOODWARD, RE. SEC. MASS. PRESS ASSOCIATION, writes: Enclosed please find subscription for one year for "*Index of Current Events*." I have examined the specimen sent me with much interest and do not hesitate to commend it as an invaluable assistant in the newspaper office. The amount of time and labor it is calculated to save, cannot be compensated by one hundred times its subscription rate.

Commencing with Vol. II No. 1 the dates given in the *Index* are the actual dates of the occurrences; no, as formerly the dates of publication.

The *Index* is published four times a month; but to form a complete file for the year it is necessary to preserve only the first issue in each month.

The immediate issues contain the news of the current month to date.

The subscription is \$6 per annum, payable yearly or half yearly in advance. Remittances should be made to

HENRY DALBY,

P. O. Box 864,

MONTREAL, Que.

# THE INDEX OF CURRENT EVENTS.

Vol. II. No. 24.

MONTREAL, JULY 6, 1889.

\$5.00 PER ANNUM.  
PUBLISHED WEEKLY.

## JUNE.

**Abyssinia, Massowah.** Italians arrest Abyssinian chief, disarm 1,000 of his followers, and occupy Keren without resistance, despatch received.—June 5.

**Abyssinia,** Missionary letters to the Anti-Slavery Society, in London, say the Mahdists have made Western Abyssinia a desert. Thousands of Christians thrown into slavery and butchered.—June 5.

**Abyssinia,** irregulars under Italian officers capture and occupy Semahet.—June 12.

**ACCIDENTS.—Colliery, Wilkesbarre, Pa.,** Gibley John and Henry, killed by fall of coal in Honeybrook colliery.—June 6.

**Asphyxia, Patterson, N. J.,** four women and two men found dead in disreputable house.—June 28.

**Cyclone, Albany, Mo.,** Williams H. P., 9 year old child of, and Crispin Mrs., killed.—June 21.

**Cyclone, Brooklyn,** unfinished building blown down, burying six persons, Henry Doscher, Italian Mosterna, John Jenkins, Matthew Doremus, Willie Doscher.—June 11.

**Cyclone, Ligonier, Mo.,** cyclone does great damage.—June 16.

**Drowning, Adolphstown, Ont.,** Lord A. P. Cecil, noted Evangelist drowned.—June 12.

**Drowning, Albany, N. Y.,** party of six drowned by collision with tug on Hudson River.—June 25.

**Drowning, Brockville, Ont.,** McFall Mr. C. C., drowned by sinking of ferry boat.—June 30.

**Drowning, Chambly, P. Q.,** Alex. Rivers and his son, aged 10, and Ls Savard, drowned by boat upsetting.—June 20.

**Drowning, Clinton, Upper Red River, Ark.,** Mrs. Emerson and seven children drowned in a flood.—June 15.

**Drowning, Long Sault, Que.,** lumbermen, Joseph Cook, Louis Lemay George Sarasin, and Mr. Windsor, drowned.—June 6.

**Drowning, Niagara Falls,** Walker Jaek and Davey Jerry drowned in attempting to cross river Chippewa.—June 8.

**Drowning, Providence, R. I.,** John Moran, James McNiff and William Hart, drowned in the harbor.—June 6.

**Drowning, Three Rivers, Que.,** bateau loaded with passengers hurled over St. Maurice River, six passengers lost.—June 22.

**Drowning, Uniontown, Mo.,** two women and four children drowned by flood.—June 16.

**Explosions, Brockville, Ont.,** works of Canada Powder Company blown up.—June 14.

**Explosion, Highlands, N. J.,** Neil Burgess the actor seriously burned by explosion of gasoline.—June 21.

**Explosions, St. Clair, Pa.,** squib factory wrecked, Mamie Mull and Harry Hayes fatally injured.—June 13.

**Fall of building, Mexico, city of,** roof of Mercil market falls, burying nearly forty persons.—June 14.

**Fire, Biloxi, Miss.,** business part of city burned by an incendiary.—June 5.

**Fire, Berlin, Mass,** dress of premier ballerina takes fire at the Opera House.—June 23.

**Fires, Boston,** four story brick structure occupied by C. E. Browning and Hayer Bros. destroyed, C. A. Gag, Thomas Payne and Samuel Cord killed.—June 21.

**Fires, Chicago,** Barton block corner of Van Buren and Clinton streets destroyed.—June 28.

**Fire, Chama, Lachan,** one half of city destroyed, 1,200 killed.—June 21.

**Fires, China, Luchow** Upper Pangtrye destroyed, 10,000 persons killed.—May 10, reported June 13.

**Fires, Cornwall, Ont.,** Cornwall Spinning Mill destroyed.—June 19.

**Fires, forest, Cascade Mountains, W. T.,** many million feet of timber destroyed.—June 16.

## ACCIDENTS.—Continued.

**Fires, Forest, Cascade county near Sand Coules, Mont.,** fire covers area of over one hundred square miles.—June 29.

**Fires, Forest, Duluth,** through Vermillion iron range.—June 6.

**Fires, forest, Minnesota,** immense amount of damage.—June 13.

**Fire, Grinnell, Iowa,** big fire at, burning great part of town.—June 12.

**Fires, forest, Washington Territory,** doing much damage in.—June 17.

**Fires, Idaho Mines, Grass Valley, Cal.,** Frank Carter, jun., killed.—June 3.

**Fire, Johnstown, Pa.,** twenty houses destroyed in first ward.—June 24.

**Fires, London, Ont.,** narrow escape from destruction, owing to crossing of electric light and telegraph wires.—June 8.

**Fires, Offenburg,** cotton mill destroyed, several workmen killed.—June 6.

**Fires, Oldham, Springfield** cotton mills burned.—June 27.

**Fires, Paris, France,** the Vieux Ch6au in the Rue D'Aubourg, the largest furniture store in Europe, destroyed.—June 21.

**Fires, Seattle, W. T.,** business part of town destroyed.—June 6.

**Fires, Stevenspoint, Wis.,** St. James' Hotel burned.—The clerk, Chas. Oatball, and two of the girls, Maggie Reilly and Nettie, missing.—June 6.

**Fire, Vancouver, W. T.,** four blocks in business portion of town, an old Catholic church and the gaol destroyed.—June 22.

**Floods, Allen County, Kansas,** great damage.—June 18.

**Floods, Clinton, Upper Red River, Ark.,** Mrs. Emerson and seven children drowned.—June 15.

**Floods, France, Bar-le-Duc,** rivers overflow, many houses undermined and destroyed.—June 21.

**Flood, Uniontown, Kansas,** and Bellefontaine flooded by bursting of dam several lives lost.—June 16.

**Floods, Walnut, Kansas,** great damage caused by, Mrs. Graham and babe drowned.—June 15.

**Hurricane, Germany, Reichenbach,** great loss of life and property.—June 5.

**Hurricane, Hong Kong,** causes loss of 10,000 lives and great damage to property.—June 4.

**Lightning, Cincinnati,** two sons of Lowe Emerson, carriage builder killed by lightning.—June 14.

**Lightning, Silesia,** five persons in procession killed by.—June 17.

**Mining, Berry Hill** coal mine at Hanley, England, caves in, hundred miners entombed.—June 3.

**Mining, Newcastle, N. S. W.,** seventy miners entombed in a pit, all rescued but two.—June 22.

**Mining, Wilkesbarre, Pa.,** Hollenback and Hellman vein mines cave in.—June 12.

**Railway, Hamilton, Ont.,** inquest into cause of accident at Junction cut, on 28th April, concluded.—June 10.

**Railway, Ireland,** train containing Methodist Sunday School wrecked near Armagh, 70 persons killed.—June 12.

**Railway, Armagh, Ireland,** verdict of manslaughter brought in against five railway employees.—June 21.

**Railway, Armagh, Ireland,** railway employees charged with causing disaster committed for trial.—June 21.

**Railway, Batavia, Ohio,** passenger train from Portsmouth to Cincinnati, on Cincinnati, Georgetown and Portsmouth Railway, goes down with trestle, fourteen persons injured, some fatally.—June 28.

**Crooked Bayon, Ark.,** train on St. Louis, Arkansas and Texas Railroad strikes a cow, S. C. Stafford, express agent, killed, and others injured.—June 26.

**Railway, Latrobe, Pa.,** triple collision of freight trains on Pennsylvania Railroad, forty cars wrecked, seven persons killed.—June 26.

**Railway, New Cumberland Junction, Pa.,** second section of mail train No. 7, bound west on Panhandle railroad wrecked, two killed, eight injured.—June 10.

## ACCIDENTS—Continued.

- Railway, New Haven, Conn., limited express which left Boston at 1 1/2 a.m. via Boston and Albany road ditched through spreading rail three persons killed, several wounded.—June 29.
- Railway, Prate Mines, Ala., train on road of Tennessee Coal, Iron and Railway Company strikes a cow and is hurled down embankment, Walter Bourly and Henry McAulay, carpenters, killed, others injured.—June 18.
- Railway, Pittsburg, Cincinnati and St. Louis Ry., gravel train collides with passenger train, killing Chas. Rodgers, and fatally wounding Wm. Brown, engineer.—June 11.
- Railway, Sugar Notch, Pa., Westbound train on Lehigh Valley Road wrecked through, breaking axle, 16 passengers seriously injured.—June 10.
- Shipping, Quebec, small steamer sunk by the "Montreal," Miss Emily Wheeler drowned.—June 12.
- AFRICA.—Germans proclaim active hostilities against insurgents, north of Bagamozu.—June 1.
- South Commission, Sir Hercules Robinson definitely retires from.—June 3.
- South, Governorship, Sir Henry Loch appointed to hold with high commissioner.—June 24.
- Korn district, Italian troops occupy, announcement made by Premier Crispi in Italian Chamber of deputies.—June 6.
- East African Company recalls their agent.—June 12.
- East, Pangin advices from, received at Zanzibar that Arabs have rejected Capt. Wismann's terms and that attack is imminent.—June 22.
- Agrarian congress opens at Paris, France.—June 10.
- Albany, Mo., cyclone, H. P. Williams, 9 year old child of, and Mrs. Crispin, killed.—June 21.
- Algoma, diocese of, Parry Sound, Ont., meeting of Diocesan Council.—June 14.
- Alien contract law, European professors for new Catholic University, Geo. Hepburne, solicitor of U.S. Treasury, is of opinion proposed engagement would be violation of the law.—June 4.
- Alien contract labor law, Washington, Secretary to the Treasury replies to Secretary of State, on representation of British Minister, that law must be enforced.—June 18.
- Alien, Contract labor law, Thousand Islands, Mr. Taylor, M.P., interviewed at Ottawa on feeling aroused.—June 21.
- Allen County, Kansas, floods cause great damage.—June 18.
- Amalgamated association of iron and steel workers at Pittsburg, communication received from Homestead Steel Works, employees objecting to Carnegie's scale.—June 12.
- American Executive Co., Chicago, license of incorporation issued to execute persons sentenced to death.—June 10.
- American Home Missions, Saratoga, N.Y. The 63rd annual meeting opens.—June 5.
- American Medical Association, Newport, R.I., fortieth meeting, opening of.—June 25.
- American Seed Trade Association, annual convention at Washington.—June 12.
- Anarchism, Switzerland, Russia, Germany and Austria send identical note to Swiss Government, advising it to deal more severely with anarchists and socialists.—June 13.
- Anarchists, German, Berlin, Dr. Adler and Herr Bretschneider, editors of *Gleichheit*, fined.—June 27.
- Aosta Duchess, gives birth to a son at Rome.—June 22.
- Arkansas City, Ark., cyclone demolishes churches and residences, and kills two persons, and injures others.—June 8.
- Armenia, Kurds continue atrocities in.—June 5.
- Armenia, Turkish atrocities in, Lord Salisbury in British House of Lords repudiates all responsibility for.—June 28.
- Arthur, late President, Chester A., monument to, in cemetery, at Albany, N.Y., unveiled.—June 15.
- Asbury Park, N.J., renewal of rice war.—June 27.
- Astronomy, Lyn, Mass., Mitchell Miss Maria, noted astronomer, death of, at Lyn, Mass.—June 30.
- Austin, Tex., in an attempt to arrest a white man by colored constable four white men and two negroes killed, and a dozen fatally injured.—June 14.
- AUSTRIA.—Government suppresses Socialist paper *Gleichheit*.—June 21.
- Klodus, riots by striking miners, many buildings wrecked and houses fired.—June 22.
- Vienna, delegations received by Emperor Francis Joseph who addresses them and prays for the peace of Europe.—June 23.
- Second strategic railroad from Haven to Miskoleg, Austria, commenced.—June 24.
- Austrian Delegations, Count Kalnoky makes speech to show peace of Europe not endangered.—June 25.
- Balfour Mr., in speech at Portsmouth, deals with Irish Land question.—June 5.
- Balfour Mr., at a banquet given by Constitutional Union, denounces application of Federal principle to British empire.—June 19.
- Bank, Caspian Bank, with capital of 5,000,000 roubles, established at Moscow.—June 12.
- Bank, Clay County, Cas., bank assigns.—June 10.
- Banks, Merchants Bank of Canada, annual statement of, issued.—June 11.
- Banks, Montreal Bank of, annual meeting of, at Montreal.—June 3.
- Banks, Quebec Bank, annual meeting of, at Quebec.—June 3.
- Banks, Toronto, Central Bank liquidation case, amount of remuneration to liquidators decided by Master in ordinary.—June 20.
- Bankruptcy, London, Eng., Manville Viscount, proceedings in Court, payment deferred until after Duke of Manchester's death.—June 27.
- Baptists, Toronto, district Baptist Association, session of.—June 21.
- Baptist Church Eastern Association, Sherbrooke, P.Q., annual convention.—June 13.
- Baptist German, Harrisonburg, Va., convention at.—June 12.
- Baxter A. E., of New York, appointed U.S. marshal for northern district of New York.—June 12.
- Bavaria, disastrous floods in.—June 6.
- Beecher Rev. William Henry, death of, at Chicago.—June 23.
- Behring Sea, United States revenue cutters ordered to seize all vessels engaged in illicit killing of seals *vide* New York *Herald*.—June 17.
- Behring Sea, Secretary Blaine and Sir Julian Pauncefote hold conference at Washington on controversy.—June 25.
- Belgium, Chamber of Deputies, M. Jansen accuses the ministry of inciting agents to provoke disorder at Mons.—June 18.
- Births, Aosta Duchess of, at Rome.—June 22.
- Bishop Washington Irving, New York, grand jury finds indictments against, Doctors Irwin, Ferguson and Hance perform autopsy.—June 10.
- Bosnia, fighting between Turks and insurgents at Novi-Bazar.—June 16.
- Bosnia and Herzegovina, revolutionary manifesto distributed, throughout warning the people that Austria moving to annex them.—June 19.
- Boulanger, Laguerre Deputy makes a speech at St. Andrew's Hall, London, Eng., to arrange for banquet on July 14, utmost disorder prevails.—June 26.
- Brazil, liberal ministry formed in.—June 10.
- Brazil, telegraph cable from Brazil to United States, government declares concession granted to Henry Cummins lapsed.—June 10.
- Breweries, Newark, N.J. The English Brewing Syndicate secures control of the Ballantine brewery.—June 5.
- Breweries, Newark, N.J., Frank J. Kastner's brewery sold to syndicate.—June 14.
- Brewery, Poughkeepsie, N.Y., Vassar Brewery sold to English Syndicate.—June 23.
- Brotherhood of United labor, Chicago, meeting of organizing committee, plan of government decided upon.—June 15.
- Brotherhood of engineers, charter of division 97 at St. Louis suspended by chief engineer Arthur.—June 8.
- Brown Levi W., of Ohio, appointed U.S. consular general at Glasgow.—June 15.
- Bruno, statue of, unveiled at Rome, with imposing ceremony.—June 9.
- Bucket shops bill, Albany, N.Y., Governor Hill signs.—June 11.
- Bucket shops, New York, suspend operations.—June 12.
- Cambria City Pa., three members of Fourteenth regiment arrested charged with insulting women.—June 17.
- Cameron Gen. Simon, dies at Lancaster, Pa.—June 26.
- Canada company, meeting of, at London, Eng.—June 28.
- Canada, United States Senate committee on relations with, St. Paul, Minn., witnesses examined at.—June 10.
- Canada, United States Senate committee on relations with, St. Paul, Minn., Senator Hoar, chairman of the committee, interviewed.—June 10.

Reichheit.—June 21.  
 wrecked and houses  
 is Joseph who ad-  
 —June 23.  
 Austria, commenced.  
 to show peace of  
 Land question.—  
 on, denounces appli-  
 June 19.  
 ables, established a  
 of, issued.—June 11.  
 deal.—June 3.  
 June 3.  
 of remuneration to  
 e 20.  
 ceedings in Court,  
 ater's death.—June  
 of.—June 21.  
 annual convention  
 June 12.  
 or northern district  
 June 23.  
 o seize all vessels  
*Herald*.—June 17.  
 ate hold conference  
 ministry of inciting  
 finds indictmen-  
 perform autopsy.—  
 Bazar.—June 16.  
 istributed, throughout  
 x them.—June 19.  
 Andrew's Hall, Lon-  
 most disorder pre-  
 vernment declares  
 June 10.  
 te secures control  
 dd to syndicate.—  
 English Syndicate  
 nizing committee,  
 ous suspended by  
 al at Glasgow.—  
 onic —June 9.  
 June 11.  
 egument arrested  
 with, St. Paul,  
 with, St. Paul,  
 e, interviewed.—

Canada, United States Senate committee on trade relations, Minneapolis, Minn., session held at.—June 11.  
 Cape Colony, Sir Henry Lock accepts governorship of.—June 22.  
 Carbuilders' Master Association, Saratoga, annual convention opens.—June 25.  
 Cashmere Sir Lepel Griffin, proposes to colonize with Englishmen as a bulwark to Indian Empire.—June 18.  
 Cattle, amalgamation of cattle and fresh meat interests of the C. and Joseph Eastman Company, of New York, and John Bell and Sons Ltd., of London and Liverpool effected.—June 19.  
 Cecil Lord A. P., hotel Evangelist, drowned at Adolphustown, Ont.—June 12.  
 Chicago, *Daily News* lays before Citizens Association details of a plan to defraud the county out of more than a quarter of a million dollars, in taxes.—June 11.  
 CHINA.—Hong Kong, hurricane causes loss of 10,000 lives and great damage to property.—June 4.  
 Luchow Upper Pangtrye destroyed by fire, 10,000 persons killed.—May 10, reported June 13.  
 Chinese exclusion, Solicitor Hepburn gives opinion to U.S. Secretary of Treasury that nothing in the law to prohibit the landing of Chinese laborers merely to pass through the territory of United States in transit.—June 24.  
 Cigar Trade, National Assembly of, convenes at New York.—June 11.  
 Clan-na-Gael, Archbishop Feehan of Chicago given instructions by the Pope to declare the Clan-na-Gael in opposition to the Church.—June 23.  
 Clan-na-Gael, Chicago, Camp 20 disbanded.—June 25.  
 Clan-na-Gael, Pope's condemnation of, affirmed, *London Standard's* Rome correspondent.—June 28.  
 Coal, anthracite, Canmore, N.W.T., Dominion Government notified of discovery of, by Mr. Binkerhoff.—June 20.  
 Coal, Mooninghela coal operators decide to consolidate and form one gigantic company.—June 28.  
 Coal, New York, agents decide to advance prices five to fifteen cents a ton on July 15.—June 26.  
 Colby Gardner R., death of, on train, near Monmouth Beach, N.J.—June 20.  
 Columbus, Ohio, Republican State convention renominates J. B. Foraker for governor on second ballot.—June 26.  
 Comet, Bernard Prof. of Lick Observatory, Cal., discovers faint new comet in Andromeda.—June 24.  
 Congregational Union, Brantford, Ont., opening of annual meeting.—June 6.  
 Connecticut Legislature, House defeats the bill giving women the right to vote on questions pertaining to the sale of intoxicating liquors.—June 4.  
 Connecticut Senate sustains governor's veto of secret ballot bill.—June 13.  
 Connecticut House concurs with Senate in the adoption of secret ballot bill.—June 21.  
 Co-operative Congress in session at Ipswich.—June 10.  
 Co-operative Congress condemns the Sugar convention.—June 11.  
 Corea, Dear Island in, occupied by Russia as a coaling and naval depot.—June 23.  
 Crops, Long Island, locusts doing much damage to crops.—June 10.  
 Crete, Greek Government acting as peacemaker between warring factions.—June 13.  
 Crete, Porte sends six Syrian battalions to.—June 14.  
 Crete, Berlin *Kreuz Zeitung* says Emperor William has dissuaded the Porte from ceding Crete to England, and has advised Sultan to cede the Island to Greece.—June 19.  
 Crete annexation of, danger to England discussed in British House of Lords.—June 24.  
 CRIME.—Absconders, Louisville, Mireau L. H., reeve of the county and ex-mayor of the parish.—June 4.  
 Absconders, Baden, postmaster at Koenigsbaek named Venner absconders with large sum to America.—June 25.  
 Absconders, New York, Dehann Charles, defaulting cashier of National Bank, sentenced.—June 24.  
 Defaulters, Kingston, Burns Rev. R. T., deputy postmaster, arrested for embezzlement.—June 24.  
 Defaulters, Philadelphia, Wright George A., treasurer of Order of Tont, warrants for his arrest issued.—June 28.

## CRIME—Continued.

Defaulters, Salt Coats, Man., Crqubart, express agent, 13 charges brought against. Committed for trial.—June 25.  
 Defaulters, Toronto, Barnett Roland Gideon Israel, for appropriating securities of Central Bank.—June 26.  
 Defaulters, Winnipeg, ex-chief McRobie goes to St. Paul, Minn., with Firemen's fund.—June 13.  
 Embezzlers, Kingston, Burns Rev. R. T., post office embezzler, sentenced.—June 26.  
 Embezzlers, Lawrence, Kansas, Woodruff Frank L., late assistant postmaster, arrested for embezzlement.—June 15.  
 Robbery, Postal car on Intercolonial Ry., between Shubenacadie, N. S., and Windsor Junction.—June 12.  
 Sentling, The "Gyle" case, prisoners to be released from prison next May, despatch received at Ottawa from Colonial office.—June 4.  
 Swindle, Gold Brick, San Francisco, Coombs, S.C., victimised for \$8000 by two adventurers.—June 24.  
 Crops, Hungary, wheat reported fair, and rye and barley better than in 1888.—June 5.  
 Cuba, in the Spanish Cortes, Senor Becerra, Minister of the Colonies, reaffirms that United States government has made no proposition for purchase of.—June 21.  
 Customs, Buffalo, Morgan W. J., editor of *Buffalo Commercial Advertiser*, appointed collector for district.—June 27.  
 Customs, Canadian, Winnipeg, horses team of, brought by man named McCowan across boundary line, seized.—June 24.  
 Customs, Canada, spruce logs, order-in-council at Ottawa, as to exemption from export duty.—June 10.  
 Customs, France, officers arrested for complicity in scheme to defraud the Government.—June 4.  
 Customs, Germany, Vosges department, Custom House officers and smugglers, desperate affray, girls killed.—June 5.  
 Customs, Halifax, N.S., schooner "Warrior," from Boston, seized for having on board one barrel of oil not on manifest.—June 18.  
 Customs, North Sydney, C.B., French schooner "Denx Sœurs" seized for smuggling liquor.—June 18.  
 Customs, U.S., Railway Freight Car Truck, Treasury department at Washington decides pair of trucks imported into Morristown, N.Y., are subject to duty.—June 24.  
 Cyclone, Arkansas City, Ark., cyclone demolishes churches and residences, and kills two persons and injures others.—June 8.  
 Davis Mr. William, well-known contractor, dies at Ottawa.—June 16.  
 DEATHS.—Richard M., governor general of French Indo-China.—June 5.  
 Bakeman Mr., eminent English engineer, who had charge of extensive works in Buenos Ayres.—June 10.  
 Beecher Rev. William Henry, at Chicago.—June 23.  
 Brompton Mr. F., late general manager of Great Western Railway, dies at Eastwood, Ont.—June 4.  
 Cameron Gen. Simon, dies at Lancaster, Pa.—June 26.  
 Cecil Lord A. P., drowned at Adolphustown, Ont.—June 12.  
 Colby Gardner R., on train near Monmouth Beach, N.J.—June 20.  
 Cole Louis M., general ticket agent of Baltimore and Ohio Railway.—June 4.  
 Davis Mr. William, well-known contractor, Ottawa.—June 16.  
 DeBellefeuille Lt-Colonel, paymaster of 5th and 6th Military districts, Canada, death of, at Longueuil, P.Q.—June 3.  
 Gabriel Arshini, full-blooded Montagnais Indian, at Pointe des Monts, P.Q.—June 21.  
 Gilbert John, veteran actor, at Boston.—June 17.  
 Gray Hon. J. in Hamilton, Justice of Supreme Court, at Victoria, B.C.—June 5.  
 Hayes Mrs. Rutherford B., wife of ex-President Hayes, dies at Fremont, Ohio.—June 25.  
 Hunter Dr. James B., well-known surgeon, and editor of *New York Medical Journal*, dies at New York.—June 10.  
 Keenan Jim, sporting man and backer of Jake Kilrain, death of, at Somerville.—June 16.  
 Lamontagne Lt-Col. D. A. G., of 6th Military district, at Montreal.—June 10.  
 Langevin Rev. Edmond, Grand Vicar of R. C. Diocese of Rimouski.—June 2.  
 Mitchell Miss Maria, noted astronomer, at Lynn, Mass.—June 30.  
 Myers Gen. A. C., late quarter-master of Confederate army, at Washington.—June 26.



## DEATHS.—Continued.

- Patti Carliott, singer, at Paris, France.—June 28.  
Powell Walter Rice, M.P. for West Carmarthenshire, death of.—June 26.  
Princess Eugenie Esterhazy, at Vienna.—June 12.  
Stephens, capt. of steamer "Peruvian," dies on voyage from Halifax, N.S.—Reported June 19.  
Swinburne Mr., formerly H. M. Stanley's assista. death of, at the Lower Congo.—May 3, reported June 27.  
Deatur, H., floods break through four levees, and do great deal of damage.—June 12.  
Dental Association of Eastern Ontario, annual meeting of, at Corawall, Ont.—June 18.  
Depew Channey M., interviewed in New York, as to his visit to Washington and the relationship between President Harrison and Mr. Blaine.—June 28.  
Diphtheria, Steiway settlement, L. I., epidemic of.—June 13.  
DIPLOMATIC.—United States and Italy, Porter Mr., presents his credentials to King Humbert.—June 6.  
Turkey, American Minister arrives at Constantinople.—June 25.  
United States and Germany, President appoints William Walter Phelps.—June 26.  
Vienna, Andrassy Count, resigns from Hungarian delegation.—June 24.  
Divorce, London, Darbshire Francis, applies for divorce from his wife, acting under the name of Agnes Hewitt, for adultery with George Baird.—June 18.  
Dominion Women's Christian Temperance Union, Toronto, second annual convention of.—June 11.  
Duel, Angustine, Texas, Reub Polk, jun., and George Andry, fight duel with Bowie knives, Polk killed.—June 11.  
Earthquake, Brest, violent shock.—June 7.  
Earthquake, New Bedford, Mass., distinct shock felt at 10.35 a.m.—June 7.  
East African Company recalls their agent.—June 12.  
Earthquake, Nashville, Tenn., shock felt at.—June 5.  
Earthquake, Susanville, Cal., severe shocks felt at.—June 27.  
ECCLESIASTICAL.—Bay of Quinte, Methodist conference meeting at Belleville.—June 6.  
Algoma, diocese of, Parry Sound, Ont., meeting of Diocesan Council.—June 14.  
Baptist convention at Sherbrooke, P.Q.—June 13.  
Baptist German, Harrisonburg, Pa., convention at.—June 12.  
Chicago, Beecher Rev. William Henry, death of.—June 23.  
Chicago, Clan-na-Gael, Archbishop Feehan receives instructions from the Pope to declare society in opposition to the church.—June 23.  
Cleary Most Rev. James, R. C. Bishop of Kingston, Ont., nominated to be Bishop of diocese of Waterford and Lismore.—June 24.  
Ireland, Presbyterian Church of, assembly of, at Belfast.—June 3.  
London, Ont., Methodist conference.—June 6.  
London, Eng., Cardinal Manning receives into R. C. church Rev. Mr. Townsend, recently principal of Oxford Mission, at Calcutta; also six former clergymen of Anglican Church.—June 16.  
London, England, Methodist new connection, annual conference.—June 19.  
London Methodist conference decides to join movement in favor of an Ecumenical conference in America in 1891.—June 12.  
Montreal, diocese of, opening of Synod.—June 18.  
Montreal District Methodist conference at Sherbrooke, stationing committee completes its labors.—June 4.  
Natchez, Rev. Father Thomas Heslin, consecrated bishop of, at New Orleans.—June 18.  
Nova Scotia, Methodist conference meets at Liverpool, N.S.—June 19.  
Ontario Diocesan Synod, opening of, at Kingston, Ont.—June 18.  
Paris, Cardinals' hats presented to Archbishops of Paris, Lyons and Bordeaux, by President Carnot.—June 11.  
Pope, the, Barcelona Bishop of, instructed to prepare an Asylum in Spain for the Pope.—June 25.  
Richmond, Va., Rev. A. Van de Vyver, vicar general of diocese elevated to bishopric.—June 3.  
Rimouski, P.Q., Langevin Rev. Edmond, Grand Vicar of R. C. diocese of Rimouski, death of.—June 2.  
Sherbrooke, P.Q., Montreal conference of Methodist Church of Canada opens its sixth annual session.—June 6.  
Toronto Anglican Synod, opening of.—June 11.  
Toronto, Bishop Lewis of, declines charge of Chaplaincies in Northern Europe.—June 25.  
Toronto, district Baptist Association, session of.—June 21.  
Edinburgh, Lord Provost of, refuses to confer freedom of the city to Parnell.—June 13.

- EGYPT.—Debt, conversion of, discussion upon, in French Chamber of deputies.—June 4.  
Preference debt of, Great Britain and Germany ratify proposition for conversion of.—June 7.  
Egyptian debt conversion scheme, abandoned in consequence of England declining to guarantee the evacuation of Egypt as demanded by France.—June 26.  
ELECTIONS.—Ireland, Cork, Fouth East Division, John Morrugh, Home rule relected without opposition to House of Commons.—June 3.  
France, Campaign opens with meeting at Montmartre.—June 17.  
France, Ivez-sur-Seine, Boulanger, Laguerre, Naquet and Laisant head the poll in municipal election.—June 16.  
France, Puy de Dome, M. le Guay elected senator.—June 15.  
Germany, Apeurade in Schleswig elects German deputy for first time since Union.—June 25.  
Germany, Metz, Lunique Herr, elected to Reichstag.—June 27.  
Lennox, Ont., Conservatives of, meet at Napanee and nominate Dr. W. W. Macnamer for Ontario legislature.—June 17.  
Electric Sugar refinery frauds, New York, Howard William E., convicted of grand larceny and sentenced.—June 21.  
Engineers Loco, brotherhood of, Chief Arthur declares himself at secret meeting of deputies opposed to strikers.—June 1, reported June 4.  
Engineers, American, Leamington, Eng., Wellesley Rt. Hon. Arthur, Speaker of House of Commons, welcomes them.—June 10.  
Engineers, American, London, Eng., Institute of Civil Engineers give reception to.—June 13.  
Engineers, brotherhood of, charter of division 97 at St. Louis, suspended by Chief Engineer Arthur.—June 8.  
Engineers, locomotive, Moncton, N.B., convention of.—June 12.  
Erie Canal, Macedon, break in new lock, traffic suspended.—June 20.  
Failures, Montreal, Claxton T. J., & Co., manufacturers' agents and importers.—June 22.  
Failures, Ottawa, Brown W. E., true bill found against, for fraudulently disposing of his property.—June 17.  
Failures, St Paul, Eureka Improvement Company makes an assignment.—June 26.  
Failures, Versailles, Conn., Woollen Company.—June 21.  
Fisheries, Newfoundland, Captain Delaney of steamer "Volunteer" reports all quiet along French shore, Lobster and Cod fisheries good.—June 24.  
Fisheries, instructions received from Ottawa to release the "Mattie Winship," upon U.S. consul Phelao giving security for her value.—June 4.  
Forsters, High Court of Canadian order, London, Ont., tenth annual meeting of.—June 11.  
Forsters Canadian High Court, meeting of, at London, Ont., election of officers.—June 14.  
FRANCE.—Cabinet considers favorably request of American residents to hold public celebration in Paris on July 4.—June 6.  
Angouleme, Boulangist meeting announced to be held at, prohibited by the authorities, citizens arrested for protesting against prohibition.—June 9.  
Angouleme, trial begun of M.M. Derooude, Lasaunt and Laguerre, for resisting authorities when they forbade Boulangist meeting.—June 11.  
Angouleme, Mr. Derooude and other Boulangists released pending further proceedings.—June 15.  
Angouleme, Boulangists arrested, trial of, begun.—June 20.  
Angouleme, trial of Derooude, Laguerre and Lasaunt for rioting completed.—June 24.  
Angouleme, sentences pronounced upon M.M. Derooude and Laguerre, Government lodges appeal to have judgment set aside and cases retried.—June 25.  
Bar-le-Duc rivers overflow, many houses undermined and destroyed.—June 21.  
Beziers, rival meetings held by supporters of the Government and friends of Boulanger, hand to hand fight ensues.—June 23.  
Boulanger Gen., letters from, to Boulangist National committee seized by police in house of Madame Boulon.—June 14.  
Boulanger Gen., writes as to how Boulangist documents were obtained by authorities at Paris.—June 19.  
Boulanger's pension stopped at request of Senate Committee.—June 25.

French Chamber of  
 nify proposition for  
 quence of England  
 pt as demanded by  
 John Morrrough,  
 se of Commons.—  
 June 17.  
 et and Laisant head  
 —June 15.  
 eputy for first time  
 —June 27.  
 g.—June 27.  
 and nominate Dr.  
 17.  
 illiam E., coovicted  
 s himself at secret  
 1, reported June 4.  
 Rt. Hon. Arthur,  
 —June 10.  
 ivil Engineers give  
 t. Louis, suspended  
 —June 12.  
 ended.—June 20.  
 ners' agents and in-  
 ast, for fraudulently  
 makes an assignment.  
 June 21.  
 "Volunteer" reports  
 d fisheries good.—  
 e the "Mattie Winy-  
 for her value.—  
 Ont., tenth annual  
 on, Ont., election o  
 e American residents to  
 e held at, prohibited  
 ing against prohibi-  
 nt and Laguerre, for  
 langist meeting.—  
 released pending fur-  
 —June 20.  
 sant for rioting com-  
 M Deroude and  
 elouget set aside and  
 ured and destroyed.  
 the Government and  
 —June 23.  
 National committee  
 —June 14.  
 ements were obtain-  
 te Committee.—June

## FRANCE.—Continued.

Chamber of deputies, Egyptian debt, conversion of, discussion upon.—  
 June 4.  
 Chamber of deputies, Left's annual amendment to suppress the credit  
 for the embassy at the Vatican rejected.—June 4.  
 Chamber of deputies, Hayti policy of Government attacked by M  
 Faure.—June 4.  
 Chamber of Deputies, Ferry M., speaks on educational and religious  
 matters.—June 6.  
 Chamber of deputies, debate on educational budget in Chamber of  
 Deputies, Ex Premier Ferry speaks.—June 6.  
 Chamber of deputies, educational budget, discussion on, continued,  
 Count Albert Dumon makes attack on ex-Premier Ferry.—June 8.  
 Chamber of deputies, debate on suppression of Boulangist meetings,  
 uproar in the Chamber.—June 11.  
 Chamber of Deputies, Goblet M., comments on Mr. Ferry's speech of  
 6th inst.—June 11.  
 Chamber of Deputies, Panama Canal relief bill introduced.—June 13.  
 Chamber of deputies, Naval proposals, M. Roche moves that house  
 cuts credit for 915,000 francs to complete.—June 18.  
 Chamber of deputies, Foreigners' children born in France, bill con-  
 cerning same passed.—June 19.  
 Chamber of deputies, members of the Right issue manifesto declaring  
 they are aggrieved at action of Republican majority in the Cham-  
 ber.—June 23.  
 Chamber of deputies, war budget passed.—June 24.  
 Chamber of deputies, arrest of M.M. Laguerre and Laisant, question  
 asked upon, produces scene in Chamber.—June 25.  
 Chamber of deputies, Panama Canal Company, bill for relief of  
 approved by.—June 26.  
 Customs officers arrested for complicity in scheme to defraud the  
 Government.—June 4.  
 Electoral campaign opens with Boulangist meeting at Montmartre.—  
 June 17.  
 Gilly Numa fined for libelling M. Sallis, leaves France to avoid arrest.  
 —June 6.  
 Lisieux, proposed Boulangist meeting at, prohibited by the authorities.  
 —June 16.  
 Literary congress at Paris, scene of disorder caused by Boulangist  
 partisans.—June 27.  
 Napoleon Prince Victor, writes letter endorsing the statements ex-  
 pressed in manifesto of members of the Right in the Chamber of  
 deputies.—June 25.  
 Paris, Society Mobiliers frauds, M. Meyer, Paris, financier, sentenced  
 to imprisonment.—June 21.  
 Paris exhibition, Lord Lytton's address, Radical and Opportunist  
 deputies sign address concerning England from any malevolent  
 design.—June 5.  
 Paris exhibition, absence of Lord Lytton, 250 members of French  
 Chamber of deputies sign response to memorial sent by members of  
 British House of Commons.—June 6.  
 Paris, Cabmen, strike of, decided upon at meeting presided over by  
 deputy.—June 12.  
 Paris, Directors of certain newspapers charged with insulting Chief  
 Magistrate sentenced to terms of imprisonment.—June 8.  
 Paris, Fleuchart Captain, of the War office, High Court orders arrest  
 of, for implication in Boulangist plot.—June 8.  
 Paris, Reicher M., one of attaches of Ministry of War, arrested for  
 implication in Boulangist plot.—June 8.  
 Senate forwards to Public prosecutor report on case of Gen. Boulan-  
 ger.—June 15.  
 Senate committee to enquire into charges against Boulanger com-  
 pletes its work.—June 21.  
 Senate adopts bill for the improvement of harbors of Cherbourg, Brest  
 and Toulon.—June 24.  
 Versailles, meeting of States Generals 100 years ago commemorated.  
 —June 20.  
 Freighters lake, drop of, despondency at Chicago.—June 21.  
 Frye G., of Maine, appointed U.S. consul-general at Halifax.—June 15.  
 Gaubling, St. Louis, twenty nine "tin horse" games raided and seventy-  
 five arrests made.—June 22.

Genesee Valley, N.Y., Caba reservoir, committee appointed to examine  
 same, report dam perfectly safe.—June 11.  
 German Baptists, Harrisonburg, Va., annual meeting.—June 11.  
 GERMANY.—Reichenbach, hurricane and waterspout cause great loss of  
 life and property.—June 5.  
 Berlin, Shah of Persia arrives at.—June 9.  
 Berlin, Emperor and Shah attend military review.—June 11.  
 Berlin, editors of *Gleichheit*, Dr. Adler and Herr Bretschneider find  
 for being anarchists.—June 27.  
 Dresden, Military review before the Emperor and king of Saxony.—  
 June 18.  
 Gastien, monument to Emperor William First unveiled at.—June 17.  
 International labor congress, consent withdrawn to send representa-  
 tive to Berne.—June 26.  
 Leipsic district, Federal council issues decree relieving state of siege,  
 —June 27.  
 Makes demand upon France for compensation for arrest of alleged  
 spy named Lechner near Belfort.—June 19.  
 Masons, 12,000 leave Berlin and go to seek work in the country.—  
 June 8.  
 Russia, memorial handed to Emperor William by General Count Von  
 Waldersee, setting forth the fact that Russia arming her troops.—  
 June 4.  
 Vosges Department, Custom House officers and smugglers, desperate  
 affray, girl killed.—June 5.  
 Gladstone Mr., Southampton, enthusiastic reception at.—June 5.  
 Gladstone Mr., addresses liberal meeting at Weymouth, and admits con-  
 dition of Ireland improved.—June 8.  
 Gladstone Mr. W. E., addresses enormous meeting at Redruth, Cornwall.  
 —June 11.  
 Gladstone Mr. W. E., addresses large meeting at Plymouth on Irish ques-  
 tion.—June 14.  
 Gold, Grantsdale, Missouri County, Mont., gold find by James Quick-  
 bonner in Gold Creek.—June 12.  
 Good Templars, Grand Lodge of Canada, Toronto, annual session opened.  
 —June 25.  
 Grosse Isle telegraph cable laid and goes into operation.—June 9.  
 Halifax, N. S., celebrates 110th anniversary of its settlement.—June 21.  
 Halifax City Council decides Alderman Smith forfeits his seat by accept-  
 ing payment from city for legal services.—June 23.  
 Haulan Ed., oarsman, arrives at San Francisco from Australia.—June 9.  
 Hanover, Bellebeck, crowd becomes unruly at races, four persons killed.  
 —June 12.  
 Hanover, Imbeck, students at Technical school rebel at being forbidden to  
 visit beer gardens.—June 19.  
 Haute, Maine, fighting between French and Italian navies occurs, troops  
 sent to quell the disturbance.—June 14.  
 Hayes Mrs. Rutherford B., wife of ex-President Hayes, dies at Fremont,  
 Ohio.—June 25.  
 HAYTI.—Minister at Washington receives to the effect that war ended by  
 publication of Legitime.—June 1.  
 France policy of government attacked by Mr. Faure in chamber of  
 deputies.—June 4.  
 American man-of-war "Kearsage" suddenly ordered to.—June 14.  
 Legation at Washington receives cable advice that all tranquil, and  
 reports of Hypolite's success false.—June 15.  
 Hypolite Gen., arrives at Cape Haytien with his staff, preparatory to  
 rejoining his army, information received by steamer "Delta"  
 arriving from Port de Paix at New York.—June 23.  
 Hodson George, English millionaire mill owner, buys Lincolnshire estate  
 of Marquis of Ripon, paying £350,000.—June 26.  
 Holland, king of, has serious illness.—June 20.  
 Holyoke, Mass., canal bank gives way, causing collapse of Cabot mills and  
 loss of \$10,000.—June 11.  
 Hudson Bay Company, meeting of, at London, report presented.—June 24.  
 Hungary, Government forbids holding of any demonstration at the Ravan-  
 iza Monastery on the anniversary of the battle of Kossova.—  
 June 25.  
 Hungary, wheat crop reported fair and rye and barley better than in 1888.  
 —June 5.

- Imperial Federation league, Tupper Sir Charles suggests, at meeting at London, Eng., holding a convention.—June 22.
- IMPERIAL PARLIAMENT.**—Commons, Secret Service money, Brad-  
hugh's motion to reduce the vote rejected.—June 4.
- Commons, Parents who send children out to beg, bill punishing same  
passed.—June 19.
- Commons, Ireland evictions in, motion by Mr. Ellis in favor of arbitra-  
tion rejected.—June 21.
- Commons, agricultural bill passed to committee of the whole.—June  
24.
- Commons, Irish drainage bill passed to second reading.—June 24.
- Commons, Berne conference, attitude of Lord Salisbury, debate  
thereon.—June 25.
- Commons, employment of children bill passed.—June 26
- Commons, Irish supply bill arranged not to be taken up till July 15.  
—June 26.
- Lords, European war prospects discussed, and the danger to England by  
annexion of Crete dismissed.—June 24.
- Lords, Land Transfer bill passed by majority of nine.—June 25.
- Lords, Turkish atrocities in Armenia, Lord Salisbury repudiates all  
responsibility for.—June 28.
- INDIANS.**—Governor of Minnesota advised from Mora, Minn., that Chip-  
pewa Indians at Mille Lacs massacre six whites Swedes.—June 13.
- Arden, Flat Head reserve, Sheriff Heyburn and band from Mis-  
souri county to arrest three Indian murderers have a battle, two  
Indians killed.—June 25.
- Chippewa, three companies of regular troops leave Minneapolis, Minn.,  
for Mora scene of outrages.—June 14.
- Mille Lacs, troops sent to scene of outbreak return to Port Snelling,  
trouble at an end.—June 18.
- Pointe des Monts, P. Q., Gabriel Archini, full-blooded Montagnais  
Indian, death of.—June 21.
- Standing rock settlement in Dakota, Sitting Bull interviewed and  
says he never signed a treaty and never would.—June 17.
- Sierra Madre Mountains, two white men killed by Apache Indians.—  
June 11.
- Insanity, Cambria, one McGinnis shoots Sheriff Ramsay who goes to  
arrest him, A. Rollins, and is shot by Blaise.—June 28.
- Insanity, Elk Horn, Minn., farmer McDermot hangs himself after shooting  
his wife.—June 25.
- International Labor Congress, Germany withdraws her consent to send a  
representative to Berne.—June 26.
- International Workingmen's Society, re-organization of, resolved upon at  
Latin Workmen's Congress at Naples.—June 26.
- Interstate Commerce law, Chicago, five railroad officials indicted for  
illegal discrimination.—June 1.
- Interstate commerce commission directs proceedings against Minneapolis,  
Sault Ste. Marie and Atlantic Railway for making discriminating  
rates.—June 20.
- IRELAND.**—Belfast, Nationalist meeting, letter read fr m Mr. Gladstone  
rallying the Protestants.—June 5.
- Corn Union Defence Committee of Dublin declares dividend of thirty  
per cent. on its investments in and management of boycotting  
farms.—June 3.
- Cork, meeting announced to protest against evictions on Ponsobny  
estate, to be addressed by William O'Brien, prohibited by authori-  
ties.—June 29.
- Cork, O'Brien William, M.P., and others arrested for speaking at  
prohibited meeting, riot ensues, the police fires.—June 29.
- Evictions in, motion by Mr. Ellis in British House of Commons in  
favor of arbitration rejected.—June 21.
- Gladstone Mr., addresses liberal meeting at Weymouth, and admits  
condition of Ireland improved.—June 8.
- Home Rule, Gladstone Mr. W. E., addresses large meeting at Ply-  
mouth.—June 14.
- Knockree, Father Crotty announces that church closed by order of  
Bishop O'Dwyer.—June 15.
- Land question, Balfour Mr., in speech at Portsmouth, deals with.—  
June 5.
- New Ross, meeting to protest against prosecution of Canon Doyle  
addressed by Mr. T. D. Sullivan.—June 21.
- Ponsobny estate, several families evicted, six arrests made.—June 21.
- Ponsobny estate, evictions continued, arrests made, mob dispersed.—  
June 22.
- Presbyterian Church of, Belfast, General Assembly of.—June 3.
- Ponsobny estates, work of eviction resumed.—June 18.
- Youghal, nine families evicted.—June 19.
- Youghal, O'Brien William, M.P., speaks on plantation scheme.—  
June 27.
- Irish drainage bill passed to second reading in British House of Com-  
mons.—June 24.
- Irish National league of America, President issues circular postponing  
meeting of league.—June 3.
- Irish Societies at Chicago meet and determine to throw over the Chan-  
nel societies.—June 3.
- Iron and steel workers, amalgamated association of, Pittsburg, communi-  
cation received from Homestead Steel works, employees objecting  
to Carnegie's sale.—June 12.
- Iron and steel works, Vallecjo, Cal., English Syndicate subscribes \$10,000-  
000 to establish.—June 19.
- ITALY.**—Chamber of Deputies, Italian troops in Africa occupy the Bern  
district, announcement by Premier Crispi.—June 6.
- Chamber of deputies, African credits, motion to reduce credits de-  
fined by government.—June 17.
- Prince Louis Napoleon resigns his commission in Italian army.—June  
7.
- Rome, Bruno, statue of, unveiled with imposing ceremonies.—June 9.
- Senate, Cardinal Lavigierie's mission, Premier Crispi speaks upon.—  
June 28.
- Senate, Germany and Switzerland, conflict between, Premier Crispi  
speaks upon.—June 28.
- Trieste, editor and staff of Italian Irredentist paper *Independent*,  
arrested.—June 12.
- Japan, Satow Mr. H., of the Imperial Commissioners, sent out by Govern-  
ment of Japan to collect information relative to different systems of  
government, arrives at Ottawa and interviews several members  
of administration.—June 21.
- Jesuit Act, Toronto, convention opens.—June 11.
- Johnstown, alarming prospects from bad sanitary state, Queen Victoria  
sends message of sympathy.—June 8.
- Johnstown, Pa., under military rule.—June 12.
- Johnstown sufferers, Cork, Ireland, public meeting of sympathy held and  
subscription list started.—June 14.
- Jones Point, N. Y., serious riot between colored men and Hungarians.—  
June 23.
- Kingston Cotton Mill, annual meeting of stockholders.—June 25.
- Lake freights, drop of, despondency at Chicago.—June 21.
- Latin Workmen's Congress at Naples resolves upon immediate reorganiza-  
tion of International Workingmen's Society.—June 27.
- LEGAL.**—Montreal, P. Q., Pagnuelo Mr. S., Q. C., appointed Judge of the  
Superior Court.—June 4.
- Breach of promise, London, Eng., Duzen Viset, settles breach of promi-  
se suit with Phyllis Broughton, by paying £2,500 and costs.—  
June 25.
- England, Mackay Mrs., brings action for libel against Manchester  
*Examiner* and London *Echo*, in stating her mother was a washer-  
woman.—June 25.
- Halifax, N.S., breach of promise case Campbell against Foteher com-  
promised.—June 11.
- Ottawa, Ayer J. C., & Co., of Lowell, Mass., enter claim against the  
Government amounting to over \$124,000 for damages.—June 10.
- Quebec, Vice-Admiralty Court, suit for damages by owners of wrecked  
steamer "Cynthia" against owners of steamship "Polynesian,"—  
June 10.
- San Francisco, suit entered by Houston David H., against city and  
county for estimated value of an Alta California grant deeded to  
Ferdinand Machina, in 1813, and including large part of best resi-  
dence portion of 1843.—June 26.
- Texas State of, against Southern Pacific Railway Company, suit  
decided at Austin in favor of the State.—June 11.
- Victoria, B. C., Gray Hon. John Hamilton, Justice of Supreme Court  
—June 4.
- Winnipeg, application of Mrs. Schultz, to restrain city from issuing tax  
certificates to land sold belonging to her, refused.—June 21.
- Leprosy, Bombay *Gazette* says brigadier general of British army stationed  
in Madras, attacked.—June 25.
- Leprosy, London, Eng., Prince of Wales, at meeting to erect memorial to  
Father Damien, states leper engaged in business at one of London's  
meat markets.—June 19.
- Ligonier, Mo., cyclone does much damage.—June 16.
- Lincoln Mr., American minister to England, luncheon given in honor of, by  
judges, at Miner Temple, London.—June 26.

House of Com-  
Circular postponing  
over the Chan-na-  
Pittsburg, commu-  
employees objecting  
subscribes \$10,000,-  
occupy the Rern  
e 6.  
reduco credits de-  
talian army.—June  
ceremonies.—June 9.  
spi speaks upon.—  
een, Premier Crispi  
paper Independent,  
sent out by Govern-  
different systems of  
vs several members  
ate, Queen Victoria  
sympathy held and  
and Hungarians.—  
e.—June 25.  
ae 21.  
Immediate reorgani-  
—June 27.  
ointed Judge of the  
settles breach of pro-  
£2,500 and costs.—  
nguint Manchester  
mother was a washer.  
gainst Fletcher com-  
e claim against the  
images.—June 10.  
y owners of wrecked  
Ship "Polynesian,"—  
I., against city and  
hia grant decided to  
ge part of best resi-  
way Company, suit  
11.  
e of Supreme Court  
city from issuing tax  
ed.—June 21.  
ritish army stationed  
to erect memorial to  
as one of London's  
given in honor of, by

Lister-Kaye Sir John, Canadian Government comes to favorable conclu-  
sion of his offer to purchase land in Northwest.—June 12.  
Loensta, Long Island, doing much damage to crops.—June 10.  
Lumber, Belleville, Ont., great jam of saw logs, breaks up.—June 7.  
Lumber, Canadian Government proposes to United States authorities  
removal of import and export duties upon.—June 27.  
Lunatics, Clifton, Tex., Olson H. D., sets fire to his house and jumps into  
the flames.—June 29.  
Lynching, Corydon, Ind., James Devine and Charles Tennyson charged  
with shooting James Lemay and niece taken from gaol and hanged.  
—June 13.  
Lynching, Helenwood, Tenn., mob breaks into gaol, takes out Lloyd and  
Reynolds, double murderers, and hangs them.—June 13.  
Mails, Sydney and San Francisco, New South Wales Government decides  
to continue contract for carrying for a year from next November.—  
June 21.  
MARRIAGES.—Washington, Justice Gray of U.S. Supreme Court and  
Miss Jeannette Matthews, daughter of the late Mr. Justice Matthews.  
—June 4.  
Berlin, Prince Frederick Leopold and Princess Louise of Schleswig  
solemnized.—June 21.  
Hohenzollern, Prince William of, to Princess Marie of Bourbon, at  
Sigmaringen.—June 27.  
London, Portland Duke of, to Miss Dallas Yorke.—June 11.  
Prince Albert Victor, eldest son of Prince of Wales, affianced to Prin-  
cess Victoria of Prussia.—June 28.  
Princess Louise of Wales, oldest daughter of Prince of Wales, betroth-  
ed to the Earl of Fife.—June 28.  
Mason Capt. John, defender of New England, in 1637, monument to, un-  
veiled, on Pequot Hill, Mystic, Conn.—June 26.  
Masons, Germany, 12,000 leave Berlin and go to seek work in the country.  
—June 8.  
Master Carbuilders' Association, Saratoga, annual convention commences.  
—June 25.  
Medical, American Medical Association, Newport, R.I., opening of fortieth  
meeting.—June 25.  
Medical, Madstone, Seaford, Mo., successful experiment on Dillon, by Dr.  
Small.—June 22.  
Medical, New York, Grand Jury finds indictments against Doctors Irwin,  
Ferguson and Hance, who perform autopsy on the body of Washing-  
ton Irving Bishop.—June 10.  
Meat, amalgamation of cattle and fresh meat interests of the C. and Joseph  
Eastman Company of New York and John Bell & Sons, Limited, of  
London, Glasgow and Liverpool, effected.—June 19.  
Medical, New York, Hunter Dr. James H., well-known surgeon, and editor of  
New York *Medical Journal*, dies at New York.—June 10.  
Medical, Ontario Medical Society, Toronto, ninth annual meeting.—June  
5.  
Medical, Ontario Medical Association, close of convention, election of  
officers.—June 6.  
Methodist conference, Bay of Quinte, meeting at Belleville.—June 6.  
Methodist conference, London, Ont., election of officers.—June 6.  
Methodist, new connection, annual conference at London.—June 10.  
Methodists, Nova Scotia, Methodist conference meets at Liverpool, N.S.—  
June 15.  
Mexico, City of, roof of Mercil market falls burying nearly forty persons.  
—June 14.  
MILITARY, Canada, DeBelleville Lieut-Col., paymaster of 5th and 6th  
Military districts, death of, at Longueuil, P. Q.—June 3.  
Austria, second strategic railway commenced from Haven to Miskoleg  
Hungary.—June 24.  
Canada, Kingston Royal Military College, closing exercises of.—June  
27.  
Canada, Dominion Government come to decision upon conflicting  
claims of London, Stratford and Windsor for military camp for No.  
1 district.—June 11.  
Canada, Lamontague Lt.-Col. D.A.G., death of, at Montreal.—June  
10.  
Canada, London, Ont., formation of six company battalions of infan-  
try ordered.—June 11.  
Canadian, Manitoba, 91st Battalion organized with companies at St.  
James, Kildonan, S. Kirk, Springfield, Stonewall and Woodlands.—  
June 11.

## MILITARY—Continued.

Canada, new decree issued, prohibiting any deputy minister from  
holding command or other such responsible position in military  
corps.—June 12.  
England, volunteer equipment fund, Prince of Wales subscribes £100  
and writes letter approving of Lord Mayor's appeal.—June 5.  
Germany, Emperor and Shah attend review at Berlin.—June 11.  
Germany, memorial handed to Emperor William by General Count  
Von Waldersee setting for the fact that Russia arming her troops.—  
June 4.  
Germany, review at Dresden before the Emperor and King of Saxony.  
—June 18.  
Germany, Lepsic district, Federal council issues decree relieving state  
of siege.—June 27.  
Italy, Prince Louis Napoleon resigns commission in Italian Army.—  
June 17.  
Montenegrin army to be organized and put in readiness for service.—  
June 11.  
Russia, strategic railways and new forts, new loan for, proposed by  
Government.—June 24.  
Russo-Serbian military convention, proposed conclusion of, by Russian  
minister to Belgrade.—June 14.  
Serbia, regents reject Russian proposals for military convention.—  
June 19.  
Switzerland, repeating rifles for army, council of Berne decides to  
borrow money to purchase.—June 24.  
Turkey sends six Syrian battalions to Crete.—June 14.  
United States, Boston Militia obtains leave from Lord Salisbury to  
visit England.—June 14.  
United States, Minneapolis, Minn., three companies of regular troops  
leave for Moran for scene of Chippewa Indian outrages.—June 14.  
United States, Cambria City, Pa., three members of Fourteenth reg-  
iment arrested charged with insulting women.—June 17.  
United States, Potomac, Society of the army of, twentieth annual  
reunion of, at Orange, N.J.—June 12.  
United States, Col. Perchment commanding fourteenth regiment  
receives orders from Governor Beaver to report with his regiment  
at Johnstown.—June 4.  
United States troops sent to outbreak of Indians at Mille Laes return  
to Port Snelling, trouble at an end.—June 18.  
United States, Washington, Myers Gen. A. C., late quarter-master of  
confederate army, death of.—June 20.  
United States, Cameron Gen. Simon, death of, at Lancaster, Pa.—  
June 26.  
Millers National Association, New York, convention of.—June 11.  
Mines, coal, Berry Hill coal mine, Hanley, England, caves in, 100 min-  
ers entombed.—June 3.  
Mines, coal, Western Pennsylvania, executive committee decides to order  
general strike.—June 13.  
Mining, Idaho mine, Grass Valley, Cal., fire breaks out in, Frank Carter,  
jun., killed.—June 3.  
Mining, coal, Monongahela coal operators decide to consolidate and form  
one gigantic company.—June 28.  
Mining, Newcastle, N.S.W., seventy miners entombed in a pit all rescued  
but two.—June 22.  
Missions, American Home, Saratoga, N. Y. The 63rd annual meeting  
opens.—June 5.  
Missouri, Governor Francis signs the Newberry bill as to saloons.—June 19.  
Mitchell Miss Maria, noted astronomist, death of, at Lyn, Mass.—June 30.  
Montreal diverse of, opening of Synod.—June 18.  
Montenegrin army to be organized and put in readiness for service.—June  
11.  
Montenegrin Government demands satisfaction from Turkey for raids on  
Albanian frontier.—June 15.  
Morgan William J., editor of Buffalo *Commercial Advertiser*, appointed  
collector of customs for district of Buffalo.—June 27.  
MURDERS, Belgium, Marchioness De Chasteler murdered in her bed at  
Chateau Bonbaix at Mons.—June 6.  
Aberdeen, Miss, Wesley Clark and Harrison Blackburn, colored, hanged  
for murder of Major Pat. Hamilton in December last.—June 12.  
Amherst, N. Y., Kennimer, the Buffalo murderer, Judge Day adjourns  
Court to hear evidence as to the effect of electric current on the  
human body.—June 25.

## MURDERS—Continued.

Cap St. Ignace, P. Q., Pernier Nelson, investigation closed, Elzear Bernier committed for trial.—June 15.

Clatham, Ont., Bear Frank, stabbed by Park Augustus, killing him instantly.—June 19.

Chicago, Cronin, John Moss of Camp No. 21 of Clan-na-Gael, gives evidence.—June 8.

Chicago, Cronin case, arrest of James Moran, driver of an ice waggon.—June 10.

Chicago, Cronin case, Coroner's Jury, verdict of.—June 11.

Chicago, Cronin case, Sullivan arrested.—June 11.

Cronin, Winnipeg, Burke alias Delaney, brought up in city police court, and remanded.—June 18.

Chicago, Cronin Dr., letter from John Fitzgerald, President Irish National League of America, to P. W. Danne of Pekin, Ill.—June 14.

Chicago, Cronin Dr., Burke arrested at Winnipeg.—June 16.

Chicago, Cronin Dr., Maroney and McDonald discharged.—June 17.

Chicago, Cronin, Bel Wm. E., of Western Union Telegraph Co., refuses to obey order of Grand Jury to produce messages.—June 18.

Chicago, Cronin, true bill found against Martin Burke.—June 19.

Chicago, Cronin Dr., Cooney Michael being looked for.—June 19.

Chicago, Cronin Dr., Kuhn's grocery clerk arrested.—June 20.

Chicago, Cronin Dr., Burke brought before Judge Bam, at Winnipeg and remanded.—June 21.

Chicago, Cronin, Brooks George E., says he saw the trunk containing Cronin's body taken from Oarson cottage.—June 22.

Chicago, Cronin, Patrick Cooney alias "the Fox" arrested at Frankfort, Ind.—June 23.

Chicago, Cronin, extradition proceedings against Burke commenced at Winnipeg.—June 25.

Chicago, Cronin, Rothacker O. H., managing editor of Omaha *Republican*, at Kansas City, Mo., declares Cronin is not dead.—June 26.

Chicago, Cronin, Spellman Edward, the Peoria distiller and district officer of Clan-na-Gael, examined.—June 28.

Chicago, Cronin, memorial meeting held at.—June 28.

Cleveland, O., Lueth Otto, the 16 year old son of Henry Lueth, a German cabinetmaker, confesses he murdered Maggie Thompson, 9 year old girl.—June 10.

Dalton, Ga., Fields S. E., State Senator, shot and killed by his step son Dennis Taylor.—June 12.

Delaware Station, Ont., man named Carter, peddler, murdered years ago, discovery of crime.—June 14.

Fergus County, five persons found in a river in Montana, all shot in the back.—Reported June 21.

France, Ville Nouvelle, a rejected suitor murders a farmer's daughter, the father and mother and a man servant.—June 10.

Gresham, Neb., Leavitt Elizabeth and Carolina found at their home with their throats cut.—June 16.

Helenwood, Tenn., mob breaks into gaol, and takes out Lloyd and Reynolds, double murderers, and hangs them.—June 13.

Holyoke, Mass., Brennan Mrs. Michael, under arrest on suspicion of poisoning her son.—June 27.

Langton, Ont., Rohrer John, aged 12, shot by Davis aged 14.—June 19.

Liverpool, Maybrick case inquest.—June 5.

Liverpool, Maybrick Mc., coroner's jury returns verdict of wilful murder, against Mrs. Maybrick.—June 6.

Liverpool, Eng., Maybrick Mrs., given hearing on charge of poisoning her husband.—June 12.

Liverpool, Maybrick case, Mrs. Maybrick committed for trial.—June 13.

London, Eng., father of a girl bicyclist stabs to death her manager.—June 21.

London, Eng., mutilated trunk found in Thames at Horseley Down, the "Jack the Ripper" scare revived.—June 4.

London, Eng., Jackson Elizabeth, body found in Thames, identified as.—June 25.

Meriden, N. B., Freeman Lucian, kills his mother, Mrs. Daniel Freeman also John Morgan.—June 11.

Mexico, Lieut. Trevitt of the Mexican Army shoots and kills Senor Don Jose De La Luz, captain of police of Juarez Paseo Del Norte.—June 8.

Millie Lines, Indians massacre six Swedes, Governor of Minnesota advised from Mora, Minn.—June 13.

## MURDERS—Continued.

New York, Francesca Sanerito, murderer Camillo Bonguti commits suicide in the Tombs.—June 13.

Ottawa, body of infant child found in closet at house on corner of Central and Bridge streets.—June 5.

Philadelphia, Whiteing Mrs., hanged for poisoning her husband and two children.—June 25.

Tainy River, Man, Johnston, murderer of Keller, found hanging to a tree.—June 3.

Sierra Madre Mountains, two white men killed by Apache Indians.—June 11.

Sunbright, Tenn., Hall Mr. Davidson, stabbed and killed by W. B. Staples.—June 16.

Topeka, Kas., a man and his wife murdered by a burglar who is caught.—June 3.

Victoria, B. C., Hoeng A. H., condemned murderer of Chinese girl, hangs himself in his cell.—June 10.

Vincennes, Ind., Seth Murray shoots and kills his wife and son's wife, and commits suicide.—June 13.

Wilkesbarre, Pa., Michael Risetto alias Red-Nosed Mike, murderer of J. Brainard McClure, paymaster, and Hugh Flanagan, hanged.—June 25.

Windsor, Ont., Lyman William, brutally assaulted by colored man, Henry William dies.—June 18.

National Association of British Americans, Boston, session at Massachusetts Association amalgamated with.—June 20.

NAVY.—British, steel torpedo depot ship "Vulcan" launched at Portsmouth.—June 13.

British, Scott Rear Admiral, in an interview maintains all the big guns practically useless in action.—June 18.

British warships "Bellerophon" and "Pylades" arrive at Halifax, N. S., from Bermuda.—June 19.

Spain, Warship "Paz" founders off Cape Trafalgar.—June 10.

United States, advertisements issued by Naval department Washington for tenders for construction of two steel cruisers of 3,000 tons displacement.—June 14.

United States, man of war "Kearsage" suddenly ordered to Hayti.—June 14.

United States Steamship "Nipsic" starts from Samoa, for San Francisco, under convey of the "Alert."—June 24.

France, ironclads in construction, M. Roche moves that house grants credit for 915,000 francs to complete.—June 18.

New Hampshire Legislature, Goodell David H., elected governor.—June 5.

New South Wales Government decides to continue for a year from next November contract for carrying mails between Sydney and San Francisco.—June 21.

Niagara, Graham's barrel boat on trial trip smashed to pieces.—June 29.

Nicaragua Canal, stockholders hold their annual meeting at Denver, Col.—June 20.

Old-follows, Canadian order of, in session at Toronto.—June 13.

Oil, Kentucky Oil and Gas Company, of Louisville, Ky., and the Southern Oil and Pipe Line agree to consolidate.—June 28.

Ontario brewers synd, opening of, at Kingston, Ont.—June 18.

Ontario Medical Society, Toronto, ninth Annual meeting.—June 5.

Panama canal, Paris, meeting of 100 shareholders decides to send commission to Panama immediately to inspect canal works.—June 3.

Panama Canal relief bill introduced in French Chamber of Deputies.—June 13.

Panama Canal Company, bill for relief of, approved by French Chamber of deputies.—June 26.

Paris, France, Agrarian congress opens at.—June 10.

PARNELL, TIMES, commission, Edward Harrington examined.—June 18.

Commission, O'Connor Mr. Thom is P., examined.—June 20.

Commission, Kenny Joseph Edward, M. P., gives evidence.—June 25.

Commission, Sexton Mr. M. P., appears as witness.—June 27.

Libel suit, appeal against postponement of trial dismissed with costs.—June 17.

Parnell Mr. C. S., Lord Provost of Edinburgh refuses to confer freedom of city upon.—June 13.

Pasteur's experiments, arrival of his representatives at Plymouth from Australia and charge that M. Pasteur's letters were opened by Provincial authorities.—June 20.

THE INDEX OF CURRENT EVENTS.

Patù Carlotta, well-known singer, dies at Paris, France.—June 28.  
 Pennsylvania, votes on amendment to state constitution prohibiting sale and manufacture of intoxicating drink.—June 18.  
 Persia, Russian, reported treaty made between Russia and Persia during the Shah's visit, for temporary annexation of Northern Persia to Russia in certain cases.—June 8.  
 Persia, Shah of, arrives at Berlin.—June 9.  
 Persia, Shah of, arrives at the Hague.—June 22.  
 Persia, Shah of, arrives at Brussels.—June 24.  
 Peters Dr., expedition of, collapses, owing to expedition among the Samalig.—June 8.  
 Petroleum, New York, flurry on the market, the oil goes up many points, and then declines.—June 24.  
 Phelps William Walter, arrives at New York with Samoan treaty, and is interviewed.—June 24.  
 Phelps William Walter, appointed by U. S. President, minister to Germany.—June 26.  
 Poisoning, Quebec, Deschamps Mr., wife and six children residing, near St. Louis Fall gate, poisoned from cream.—June 12.  
 Pope the, reopens the gates of the Vatican and resumes his receptions.—June 12.  
 Pope, Bareclona, Bishop of, instructed to prepare an asylum in Spain for the Pope.—June 25.  
 Portugal, Chamber of Deputies passes bill exempting wine from export duty, authorizing the payment of bounties to wine growers, and exempting fine brands from taxation for five years.—June 14.  
 Portugal, Parliament presents the King with \$750,000 as a token of love and loyalty.—June 17.  
 Postal, Canada and Japan, convention for exchange of money orders concluded.—June 27.  
 Postal, Hamilton, Ont., suit entered by Canadian Postmaster General against Great North Western Telegraph Company, for infringing right of Government to deliver letters.—June 20.  
 Petome, Society of the Army of Orange, N. J., annual reunion.—June 12.  
 Powell Walter Rice, M.P. for West Cambridgeshire, death of.—June 26.  
 Presbyterians, Canadian, general assembly at Toronto.—June 13.  
 Printers, Denver, Col., International Typographical convention at.—June 13.  
 Prohibition, Pennsylvania votes on amendment to state constitution.—June 18.  
 Race war, Asbury Park, N. J., renewal of.—June 27.

RAILWAYS, Baltimore, Cole Louis M., general ticket agent of Baltimore and Ohio Railway, death of.—June 4.  
 Adirondack railroad sold to Delaware and Hudson Canal Company.—June 10.  
 Atchison, Topeka and Santa Fe road announces its withdrawal from Interstate Commerce Association.—June 29.  
 Austria, construction of second strategic road from Haven to Miskoleg, Austria, commenced.—June 24.  
 Broughton Mr. F., late general manager of Great Western Railway, dies at Eastwood, Ont.—June 4.  
 Canadian Pacific, new short line to St. John, N. B., opened.—June 2.  
 Canadian Pacific, New Soo line opened.—June 3.  
 Canadian Pacific Railway versus the Queen, arbitration committee assembles at Nich Arm House, Dalhousie.—June 21.  
 Canadian Pacific Railway and Toronto, city of, delegation appears before Railway Committee of Privy Council, at Ottawa.—June 26.  
 Chicago to Montreal, contemplated lake and rail export route via Lake Michigan falls through, according to Chicago Times.—June 12.  
 Chicago, five officials indicted under Interstate Commerce law, for illegal discrimination.—June 1.  
 Chicago, general freight agents of the North Western division of the Western Freight Association meet, and appoint committee to submit proposition of Soo line to restore the tariff to managers of Lake Superior lines.—June 3.  
 Chicago, Milwaukee and St. Paul Railway makes mortgage to United States Trust Company of \$15,000,000.—June 19.  
 Congo, Huntington C. P., subscribes \$500,000 as testimonial to King Leopold's work.—June 20.  
 Congo, New York Herald's Paris cablegram says: Congo Commercial and Industrial Company complete preliminary study of projected Congo railway from Biladi to Sandy Pool.—June 20.

RAILWAYS—Continued.  
 Delagon Bay railroad, shareholders hold meeting in London, and resolve to resist any attempt on the part of Portugal to take the work out of the Company's hands.—June 27.  
 Dela row Bay, men employed on construction make ready to resist attempt of Portuguese authorities to seize the work.—June 27.  
 Delagon Bay, despatch from Durban, says Governor of Delagon Bay telegraph that decree cancelling railway concession rescinded.—June 28.  
 Delagon Bay, despatch received in London, by manager, who states Portuguese have torn up railway, and fired on English engineer, and makes demand on Lord Salisbury for intervention.—June 29.  
 Denver, Col., articles for consolidation of, proposed Denver and State Line Railroad with Rio Grande and Western, filed.—June 27.  
 Duluth, South Shore and Atlantic road announces cut for through freight from Boston and New York to head of the lakes.—June 20.  
 Employees, delegates from Brotherhood of Locomotive firemen, the brotherhood of railway brakemen and the switchmen's association at Chicago form confederation.—June 4.  
 Freight car truck, U. S. Treasury Department at Washington decides pair of trucks imported into Morristown, N.Y., are subject to duty.—June 21.  
 Freight rates, National despatch freight line announces new rates via the Northern Lake route and the Eastern Duluth and Omaha.—June 25.  
 Freight rates, Chicago, general freight agents of North Western lines fail to induce Lake Superior routes to advance rates.—June 5.  
 Georgia Pacific railroad, last spike driven.—June 18.  
 Interstate commerce, commission directs proceedings against Minneapolis, Sault Ste Marie and Atlantic Railway for making discriminating rates.—June 20.  
 Montana and Canada railroad company incorporated in Montana.—June 20.  
 Northern Pacific road, work begun on the connecting link of track uniting termini of its leased line, the Wisconsin Central and the system at Ashland.—June 21.  
 North West Central Railway Company, annual meeting at Ottawa, election of officers.—June 9.  
 Oregon and Transcontinental and Oregon Railway and Navigation Companies, annual elections of.—June 17.  
 "Soo" line reduces rates on all rail traffic from seaboard to St. Paul.—June 21.  
 "Soo" line, announces another sweeping reduction in the west bound all rail rate from the Atlantic to Minneapolis and St. Paul.—June 24.  
 Southern Pacific Railroad company complete negotiations for purchase of Oregon Railway, reported in Portland, Oregon.—June 24.  
 Sunday labor, discussed by Mr. Hickson of the Grand Trunk and Mr. Spicer of the Chicago and Grand Trunk in the Chicago Railway Times.—June 17.  
 Switzerland, railway from Alpnach to summit of Mount Pilatus opened.—June 4.  
 Telegraphing from moving trains, test at Raleigh, N.C., of process invented by Bayliss Cade, a Baptist preacher, on Raleigh and Gaston railroad.—June 18.  
 Transcontinental Association, Southern Pacific Railway gives notice of withdrawal from.—June 3.  
 Wabash and all its property turned over by Receiver McNulty in Chicago to purchasing company.—June 29.  
 Winnipeg and South Eastern Railway to connect Winnipeg with Duluth commenced.—June 27.  
 Rhode Island, fifth amendment to the constitution, the prohibitory amendment repealed.—June 20.  
 Richard M., governor-general of French Indo-China, death of.—June 5.  
 Rinderpest, Bohemia, raging among cattle.—June 17.  
 Robinson Sir Hercules, definitely retires from commissionership of South Africa.—June 3.  
 Rosier, Ind., two children eaten by wolves.—June 11.  
 Rossa O Donovan, suit of, against Patrick Sarsfield Cassidy, for libel, dismissed at New York.—June 13.  
 Rossa, O'Donovan and Wilber Hendrickson of United Irishmen arrested at New York for libel on Patrick Sarsfield Cassidy.—June 20.  
 Roumanian Chamber of Deputies, Gold standard of currency approved of.—June 11.  
 Royal Agricultural show, Windsor, Eng., opening of.—June 21.



SPAIN, Madrid, severe hailstorm passes over, doing much damage.—June 6.

Cortes opened by Premier Sagasta.—June 14.  
Cortes, Caba, Senor Ilerra, Minister of colonies, re-affirms that U. S. Government had made no proposition for the purchase of.—June 21  
Madrid, Queen Christina ascends in an army balloon.—June 28.  
Bill fighting, Carolina, Florence, fifteen bulls soured for tournament.—June 20.

SPORTS, racing, The Derby won by Duke of Portland's "Donovan"—June 5.

Aquatics, Hanlan Ed., arrives at San Francisco from Australia.—June 9.

Aquatics, Royal Canoe Club of England, canoe races at Hendon, Baden Powell comes in first.—June 21.

Aquatics, O'Connor William, leaves Toronto for England for his match with Searle.—June 24.

Baseball, Yale wins championship from Harvard.—June 26.

Bicycling, Townsend Enoch, rides from Boston to Portland on a bicycle in a single day.—June 23.

Lacrosse, Montreal beaten by Ottawa at Ottawa.—June 8.

Lacrosse, Shamrocks beat Toronto's at Montreal.—June 8.

Lacrosse, Cornwalls beat Toronto at Toronto.—June 29.

Ottawa canoe sailing race for club challenge cup won by "Musette."—June 20.

Prize ring, Kilrain-Sullivan, Governor of Louisiana issues proclamation prohibiting.—June 26.

Racing, Ascot, Ascot High Weight plate won by "Fix."—June 21.

Racing, Chicago, American Derby won by Spokane.—June 23.

Racing, controversy between Sir George Chetwynd and Lord Durham as to turf irregularities settled.—June 21.

Races, Montreal Bel-Air Jockey Club track opening races.—June 29.

Racing, Ascot, Prince of Wales stakes won by "Donovan," Ascot stakes handicap won by "Lord Lorne," gold vase won by "Morglay."—June 18.

Racing, Ascot, Royal Hunt cup won by "White Legs," Ascot, Derby stakes won by "Morglay."—June 19.

Racing, Ascot, gold cup won by "Trayles" Prona memorial stakes won by "Love-in-idleness," new biennial stakes won by "Lord Lorne," St James' Palace stakes won by "Pioneer."—June 20.

Racing, Hanover Bellerbeck, crowd becomes unruly, four persons killed.—June 12.

Racing, Oaks stakes at Epsom won by L'Abbesse de Jouarre.—June 7.

Trotting, Cedar Rapids, Ia., Axtele trots a mile in 2.21, breaking record for three year olds.—June 26.

Yachting, Eastbourne, bigger yacht "Paradox" launched.—June 6.

Yachting, London, Eng., " Valkyrie" beaten by the "Irex."—June 3.

Yacht racing, Sandy Hook, N. J., race between the "Shamrock" and the "Katum."—June 5.

Yachting, Dunraven Lord, in interview at London, Eng., speaks in high terms of his yacht "Valkyrie."—June 20.

Yachting, Queenstown regatta, the "Valkyrie" wins.—June 17.

Stanley H. M., advices from Zanzibar say letter received from regarding Stanley. Sir Francis de Winton interviewed thereon in London.—June 13.

Stanley H. M., letters dated March 10 received at Zanzibar from Ujiji stating Stanley met Tippu Tib.—June 15.

State department, Washington, desig nates Norton, Rose & Co., of London, its bankers in that city.—June 20.

Stephens Capt., of steamer "Peruvian" dies on voyage from Halifax, N.S.—Reported June 19.

Stock Exchange, New York, Ticker service resumed.—June 6.

Storm, electric, Danville, Ills., house of Fred Maguire struck, and house of Joseph Lara destroyed.—June 20.

STRIKES, Bakers, Toronto, for increased wages.—June 3.

Belgian Red Star Steamship companies employees, London, Eng.—June 14.

Cabmen, Paris, strike decided upon at meeting presided over by deputy Mayor.—June 12.

Cab drivers, Paris, strike ended.—June 18.

Carpeters, Halifax, N. S.—June 18.

Car drivers, Rochester City, and Bright Street, Brooklyn employees' strike declared off.—June 4.

Chicago, Chief Arthur of Brotherhood of Locomotive engineers declares himself opposed to.—June 5.

STRIKES.—Continued.

Coal miners, Western Pennsylvania executive committee decides to order general strike.—June 13.

Dock laborers, Glasgow, Greenock, Belfast and Londonderry, men join movement.—June 6.

Dock laborers, Glasgow, strike for an increase of a half penny per hour.—June 8.

Dock laborers, Glasgow strikers stop and set fire to a van in which provisions being carried to imported laborers in Anchor line sleds.—June 13.

Firemen on steamers crossing British Channel, steamers unable to sail.—June 5.

Firemen, Antwerp, Red Star Steamship Company grants increase of wages and strike ends.—June 13.

Glasgow, riot dispersed by Police, ringleaders arrested.—June 17.

Laboring men, Johnstown, Pa.—June 20.

Miners, Bohemia, riot at Kludus, gendarmes fire and kill two and wound twelve.—June 20.

Miners, Essex, eighteen miners sentenced to imprisonment for rioting.—June 5.

Miners, Austria, riots at Kludus, many buildings wrecked and houses fired.—June 22.

Miners, Illinois, despatches to Chicago describe the pitiable condition of the strikers and their families.—June 24.

Miners, Westphalia.—June 25.

Mountain miners and cokers from Gallitzin westward.—June 29.

Pittsburg, Pa., Green Homestead plant of Carnegie & Co., no agreement reached with workmen's conference committee, strike decided upon.—June 21.

Saw mills, Bangor, Me., men in Gould and Hastings' and Sterns and Co's mills join men out on strike.—June 24.

Seamen, Liverpool, Union seamen and firemen go on strike.—June 3

Seamen, Liverpool, Eng., crew of steamer "City of New York" strikes on order from Seaman's Union.—June 12.

Seamen, Liverpool, shipowners refuse to grant advance in wages demanded.—June 18.

Seamen and firemen, Clyde work resumed on owner's terms.—June 28.

Seamen, London, Eng., resume work.—June 20.

Silver Miners, Russia, Ural silver miners fire houses of managers of number of factories at Ekaterinburg.—June 3.

Steamship stokers, Antwerp.—June 14.

Steel plant workers, Carnegie and Co., strike against scale proposed by the firm declared on, at meeting of amalgamated workmen.—June 29.

Textile workers, Bruno, Austria, eleven thousand strike for high wages.—June 14.

Tramsters, Duluth, 400 on strike.—June 13.

Tram car employees, Cardiff, strikers using forcible means to prevent running of cars.—June 6.

Tram car employees, Cardiff men return to work.—June 6.

Turin, riot at, many arrests made.—June 12.

Suez Canal Company, Paris, annual meeting of.—June 5.

Sugar, Clyde market prices advance 9 pence, on reports that America had bought fifty thousand tons.—June 4.

SUCIDE.

Halifax, N. S., William Lucas, formerly soldier in East Devonshire regiment.—June 6

Arkansas City, man who says his name is Thompson, and ex-postmaster of Chicago, cuts his throat on train.—June 28.

Bowling Green, Ohio, Frank James, charged with attempting to blow up Mrs. Williams' house, hangs himself in goal.—June 13.

Elk Horn, Man., farmer McDermott hangs himself after shooting his wife.—June 25.

Gasque, Que., Gilbert Mr. Philip, jumps from steamship "Admiral" and is drowned.—June 13.

Halifax, N. S., Hattie Conrod, aged 19, blows her brains out at Laurierstown.—June 5.

Indianapolis, Ward Patrick A., president of the Irish American Republican Club, poisons himself at supper table.—June 13.

Martinsville, Ind., Olds W. A., prominent member of Knights of Pythias, shoots himself.—June 21.

New York, Camille Bongrath, newspaperer of Francesca Sanevito, hangs himself in the Tomb.—June 13

New York, De Courcy Col. Dennis, one of the leaders of Fenian invasion into Canada, tries to poison himself.—June 15.

Niagara Falls, Lily commits suicide at Niagara River gate.—June 14.

Uniontown, Ky., Rodgers Martin, the town marshal, cuts his throat and kills dead.—June 28.

Victoria, B. C., Huang A. H., condemned murderer of Chinese girl, hangs himself in his cell.—June 10.

Wallace, N. S., Forsburn Andrew, farmer, drowns himself.—June 15.



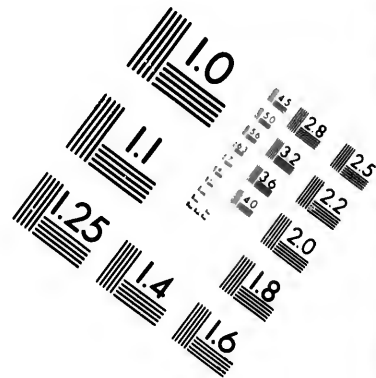
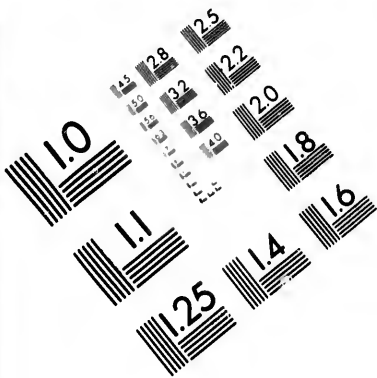

**IMAGE EVALUATION  
TEST TARGET (MT-3)**

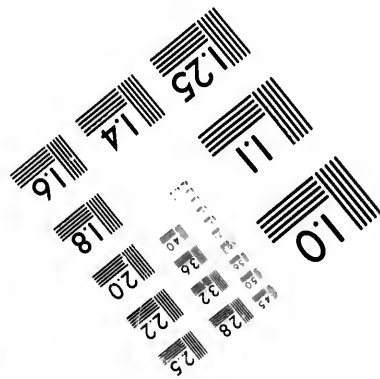
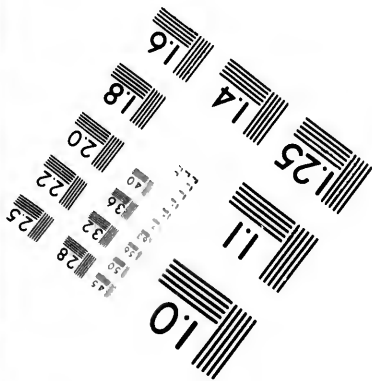
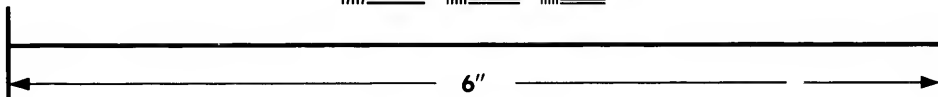
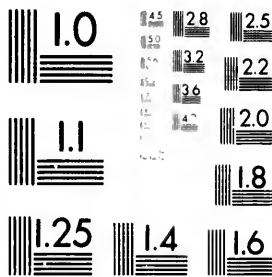

**Photographic  
Sciences  
Corporation**

23 WEST MAIN STREET  
WEBSTER, N.Y. 14580  
(716) 872-4503

28 25  
32 22  
20

10

- Sugar convention, co-operative, Congress, London, Eng., condemns same.—June 12.
- Susanville, Cal., Earthquake shocks felt at.—June 27.
- Swinburne Mr., formerly H. M. Stanley's assistant, death of, at the Lower Congo.—May 3, reported June 27.
- Switzerland, Berne, Council of, decides to borrow 16,000,000 francs with which to purchase repeating rifles for Swiss Army.—June 24.
- Switzerland, expulsion of Herr Wohlgenuth, German police inspector. German government notifies Swiss authorities they reserve the right to take action.—June 11.
- Switzerland, Russia, Germany and Austria send identical note to Swiss government, advising it to deal more severely with Anarchists and Socialists.—June 13.
- Switzerland, Bundesrath decides to create permanent public prosecutor's department, and to strengthen government's control over foreigners.—June 15.
- Switzerland, Bundesrath, in reply to enquiries by the National Rath, denies that there are any grounds for complaints by foreign powers that socialists are allowed too much freedom in Switzerland.—June 21.
- Switzerland, Government appoints permanent public prosecutor to strengthen control of police over refugees.—June 25.
- Switzerland sends reply to Germany's note on the subject of Herr Wohlgenuth's expulsion.—June 17.
- Switzerland, Germany, Wohlgenuth affair, King Humbert's offer to mediate, accepted.—June 20.
- TELEGRAPHY, Brazil to United States, Brazilian government declares concession granted to Henry Cummins lapsed.—June 10.
- Grosse Isle, cable laid and goes into operation.—June 9.
- Telegraphing from moving trains, test at Raleigh, N. C., of process invented by Baylus Cade, a Baptist preacher, on Raleigh and Gaston railroad.—June 18.
- Germany treating with Belgium, in regard to laying a cable from Osteno to Portland, Maine, *vide Paris Temps*.—June 17.
- Honolulu and San Francisco, San Francisco *Evening Post* says one million dollars subscribed for.—June 18.
- Western Union Telegraph Company declares quarterly dividend of 1 1/4 per cent.—June 12.
- Telephone, American Bell Telephone Co. declares quarterly dividend of \$3 per share and extra dividend of \$9 per share.—June 12.
- Texas State of, against Southern Pacific Railway Company, suit decided at Austin in favor of the State.—June 11.
- Thames, mouth of, severe gale at, does much damage.—June 10.
- THEATRICAL, Gilbert John, veteran actor, dies at Boston.—June 17.
- Berlin, Opera House, dress of premiere ballerina takes fire, and she is seriously burned.—June 23.
- England, employment of children bill in British House of Commons passed.—June 20.
- Highlands, N. J., Neil Burgess the actor seriously burned by explosion of gasoline.—June 24.
- London, Eng., Agnes Hewitt sued by her husband Francis Darbishire for divorce.—June 18.
- Timber, spruce logs, order-in-Council passed at Ottawa sustaining decision of Treasury Board as to loss of, certain size being free from export duty.—June 10.
- Tobacco, trust formed of \$25,000,000, which takes in all plug tobacco manufacturers in United States.—June 13.
- Toronto, Anglican Synod, opening of.—June 11.
- Toronto, Trinity College, convocation, Dr. Bourinot has honorary D. C. L. conferred upon him.—June 27.
- Tilley Sir Leonard, arrives at Vancouver, B. C., and expresses astonishment at the growth of the city.—June 5.
- Trusts, Brewery, Newark, N. J., Franz J. Kastner's brewery sold to syndicate.—June 14.
- Trusts, Elgin, Ill., watch factory, English syndicate offers to buy.—June 14.
- Trusts, National White lead trust purchases plant of the Collier White Lead Company and the Southern White Lead Company.—June 5.
- Trusts, plug tobacco manufacturers, trust of \$25,000,000 which takes in all plug tobacco manufacturers in United States.—June 13.
- Turkey, Russian overtures for convention to ensure Turkish neutrality in case of war rejected, see *Cologne Gazette*.—June 25.
- Turner Band, Cincinnati, meeting of.—June 25.
- UNITED STATES, Senate committee on relations with Canada, St. Paul, Minn. Senator Hoar, chairman of the committee, interviewed.—June 10.
- Senate Committee on relations with Canada; St. Paul, Minn., witnesses examined at.—June 10.
- Senate Committee on trade relations with Canada, Minneapolis, Minn., session held at.—June 11.
- United Workmen, Rochester, N. Y., eleventh annual session of the order opens.—June 11.
- Volunteer Equipment fund, London, Eng., Prince of Wales subscribes £100 and writes letter approving of Lord Mayor's appeal.—June 5.
- Wage, scale, Philadelphia rolling mill Association and the Amalgamated Association agree on a wage schedule.—June 29.
- Walnut, Kansas, floods cause great damage, Mrs. Grabam and baby drowned.—June 15.
- Western Union Telegraph Company declares quarterly dividend of 1 1/4 per cent.—June 12.
- White Lead, National White Lead trust purchases plant of Collier White Lead Company and the Southern White Lead Company.—June 5.
- Wilkesbarre, Pa., Hollenback and Hellman vein mines cave in.—June 12.
- Winnipeg, application of Mrs. Schultz to restrain Winnipeg from issuing tax certificates to land sold belonging to her refused.—June 21.
- Wolves, Rosier, Ind., two children eaten by.—June 14.
- Women's federation league, London, Eng., vigorous protest circulated against conduct of ladies who accompanied Sir Charles Dilke on his recent visit to Forest Dean.—June 13.
- Wool-growers Association petitions President Harrison to call special session of Congress, to take action on the wool growing industry's needs.—June 4.
- WRECKS, Aspy Bay, N. S., steamer "Bessie Morris" from Montreal for Sydney ashore.—June 3.
- "Attmore" steel ship bound from Sydney to San Francisco strikes reef off Fiji island on night of April 22nd, advices received at San Francisco.—June 8.
- Brewers' Mills, steam barge "Anglin" sinks in Rideau canal.—June 12.
- Yellow Fever, Brooklyn, N. Y., Dr. R. W. H. Dunean, surgeon of Pacific mail steamer "Colon," taken ill with.—June 19.
- Yellow fever, Rio Janeiro, Santos, epidemic creating terrible havoc.—June 14.

NEW YORK STOCK MARKET CLOSING QUOTATIONS.

JUNE.

	Saturday	Monday	Tuesday	Wednesday	Thursday	Friday	Saturday	Monday	Tuesday	Wednesday	Thursday	Friday	Saturday	Monday	Tuesday	Wednesday	Thursday	Friday	Saturday	Monday	Tuesday	Wednesday	Thursday	Friday	Saturday
Canadian Pac.	111	112	113	113	113	113	113	113	113	113	113	113	113	113	113	113	113	113	113	113	113	113	113	113	113
C. C. & J.	101	101	101	101	101	101	101	101	101	101	101	101	101	101	101	101	101	101	101	101	101	101	101	101	101
C. H. V. & T.	101	101	101	101	101	101	101	101	101	101	101	101	101	101	101	101	101	101	101	101	101	101	101	101	101
Canada Southern	102	102	102	102	102	102	102	102	102	102	102	102	102	102	102	102	102	102	102	102	102	102	102	102	102
C. B. & Q.	102	102	102	102	102	102	102	102	102	102	102	102	102	102	102	102	102	102	102	102	102	102	102	102	102
Pel. & Hudson	132	132	132	132	132	132	132	132	132	132	132	132	132	132	132	132	132	132	132	132	132	132	132	132	132
Blackwelder	288	288	288	288	288	288	288	288	288	288	288	288	288	288	288	288	288	288	288	288	288	288	288	288	288
do seconds	70	70	70	70	70	70	70	70	70	70	70	70	70	70	70	70	70	70	70	70	70	70	70	70	70
Erie preferred	101	101	101	101	101	101	101	101	101	101	101	101	101	101	101	101	101	101	101	101	101	101	101	101	101
Kan. & Texas	101	101	101	101	101	101	101	101	101	101	101	101	101	101	101	101	101	101	101	101	101	101	101	101	101
Lake Shore	101	101	101	101	101	101	101	101	101	101	101	101	101	101	101	101	101	101	101	101	101	101	101	101	101
Louis. & Nash.	101	101	101	101	101	101	101	101	101	101	101	101	101	101	101	101	101	101	101	101	101	101	101	101	101
N. Y. & N. E.	101	101	101	101	101	101	101	101	101	101	101	101	101	101	101	101	101	101	101	101	101	101	101	101	101
N. J. Central	101	101	101	101	101	101	101	101	101	101	101	101	101	101	101	101	101	101	101	101	101	101	101	101	101
Northern Pac.	101	101	101	101	101	101	101	101	101	101	101	101	101	101	101	101	101	101	101	101	101	101	101	101	101
do preferred	101	101	101	101	101	101	101	101	101	101	101	101	101	101	101	101	101	101	101	101	101	101	101	101	101
Northwestern	111	112	113	113	113	113	113	113	113	113	113	113	113	113	113	113	113	113	113	113	113	113	113	113	113
N. Y. Central	101	101	101	101	101	101	101	101	101	101	101	101	101	101	101	101	101	101	101	101	101	101	101	101	101
Nickel Plate	101	101	101	101	101	101	101	101	101	101	101	101	101	101	101	101	101	101	101	101	101	101	101	101	101
N. Y. & N. E.	46	46	46	46	46	46	46	46	46	46	46	46	46	46	46	46	46	46	46	46	46	46	46	46	46
Omaha	46	46	46	46	46	46	46	46	46	46	46	46	46	46	46	46	46	46	46	46	46	46	46	46	46
do preferred	46	46	46	46	46	46	46	46	46	46	46	46	46	46	46	46	46	46	46	46	46	46	46	46	46
Arch. & Topeka	46	46	46	46	46	46	46	46	46	46	46	46	46	46	46	46	46	46	46	46	46	46	46	46	46
Oregon Trans.	36	36	36	36	36	36	36	36	36	36	36	36	36	36	36	36	36	36	36	36	36	36	36	36	36
Pacific Mail	46	46	46	46	46	46	46	46	46	46	46	46	46	46	46	46	46	46	46	46	46	46	46	46	46
Rock Island	99	99	99	99	99	99	99	99	99	99	99	99	99	99	99	99	99	99	99	99	99	99	99	99	99
R. T.	26	26	26	26	26	26	26	26	26	26	26	26	26	26	26	26	26	26	26	26	26	26	26	26	26
St. Paul	73	73	73	73	73	73	73	73	73	73	73	73	73	73	73	73	73	73	73	73	73	73	73	73	73
Texas Pac.	21	21	21	21	21	21	21	21	21	21	21	21	21	21	21	21	21	21	21	21	21	21	21	21	21
Union Pac.	63	63	63	63	63	63	63	63	63	63	63	63	63	63	63	63	63	63	63	63	63	63	63	63	63
Wash.	16	16	16	16	16	16	16	16	16	16	16	16	16	16	16	16	16	16	16	16	16	16	16	16	16
do preferred	16	16	16	16	16	16	16	16	16	16	16	16	16	16	16	16	16	16	16	16	16	16	16	16	16
Western Union	57	57	57	57	57	57	57	57	57	57	57	57	57	57	57	57	57	57	57	57	57	57	57	57	57

ary D. C. L.  
 cases national-  
 wery sold to  
 buy. June 14.  
 Collier White  
 ny. June 5.  
 which takes in  
 ne 13.  
 h neutrality in  
 and, St. Paul,  
 interviewed.—  
 Minn., witnes-  
 neapolis, Minn.  
 on of the order  
 subscribes £100  
 June 5.  
 e Amalgamated  
 ham and baby  
 vidend of 1/4 per  
 of Collier White  
 any. June 5.  
 ve in. June 12.  
 piping from issuing  
 ed. June 21.  
 protest circulated  
 Charles Dilke on  
 a to call special  
 owing industry's  
 m Montreal for  
 Francisco strikes  
 received at San  
 Rideau canal.—  
 rgeon of Pacific  
 terrible havoc.—

**ALBEMARLE HOTEL.**

EUROPEAN PLAN,  
Broadway, Fifth-ave. & 24th-st., New York.  
(MADISON SQUARE.)  
JANVRIN & WALTER, Proprietors.

**HOTEL KAATERSKILL,**

Catskill Mountains, New York,  
Largest and Finest Mountain Hotel in the world. Rates of board moderate.  
W. F. PAIGE, Manager.  
Kaaterskill P.O., Greene Co., New York.

**WEST END HOTEL,  
LONG BRANCH,**

—SEASON OF 1889.—  
Cottages and Restaurant open Saturday, June 8th. Hotel opens June 22nd,  
with improvements and additional attractions.  
D. M. & W. E. HILDKETH, Props.

**ASTOR HOUSE,**

Broadway, New York.  
On the European Plan. | Rooms \$1.00 and Upwards.  
The accommodations of the Astor will be found first-class in every respect.  
Elevator running night and day.  
F. T. KEITH, Manager. | F. J. ALLEN, Proprietor.

**"THE BATES,"**

INDIANAPOLIS, IND.  
Rates, \$2.50 to \$5.00 per day.  
LOUIS REIBOLD, Proprietor.

**PARKER HOUSE,  
BOSTON.**

European Plan. 300 Rooms. \$1.00 and Upwards per day.  
Café of unsurpassed excellence. Private dining rooms for dinner parties.  
E. O. PUNCHARD & CO., Proprietors.

**TREMONT HOUSE,**

—CHICAGO.—  
THE "PALACE" HOTEL.  
JOHN A. RICE & CO.  
Prices, \$3.00 to \$5.00 per day. Special rates made by the week. Rooms  
single or en suite, with or without baths.  
MRS. JOHN A. RICE, Manager.

**ALBION HOTEL,**

MARKET SQUARE, - - - TORONTO.  
The best dollar a day house on the continent. Fine rooms; good service,  
every convenience. Centrally located for railways, steamboats and street  
cars.  
JOHN HOLDERNES, Proprietor.

**THE PALMER HOUSE,  
TORONTO.**

Corner King and York street. Specially adapted for Commercial men.  
\$2.00 per day.  
J. C. PALMER, Proprietor.  
Also Kerby House, Brantford.

**ST. NICHOLAS HOTEL,**

EDWARD N. ROTH,  
CINCINNATI, OHIO.  
On the European plan. Location and service unsurpassed. Every modern  
improvement. Rooms, \$1.50 per day and upwards.

**GRAND UNION HOTEL.**

Opposite Grand Central Depot,  
NEW YORK.  
Six hundred rooms at \$1 a day and upwards. Restaurants at moderate prices,  
BAGGAGE TO AND FROM GRAND CENTRAL DEPOT FREE.  
W. D. GARRISON, Manager.

**GRAND HOTEL,**

Broadway, cor. 31st-st., New York.  
ON THE EUROPEAN PLAN  
HENRY MILFORD SMITH & SON, Props.

**THE GRISWOLD,  
DETROIT, MICH.**

Located corner Griswold and Congress-streets. Newly furnished and refitted  
throughout.  
Rates, \$2 per Day.  
ALBERT MAXWELL, Proprietor. | E. T. OSHORN, Manager.

**FOREST CITY HOUSE,  
CLEVELAND, OHIO.**

Best location in the city, and the only hotel fronting on the park. Nearest  
to public buildings, opera house, churches, etc. Street cars pass the house to  
all parts of the city, suburbs and depots. Rates, \$2.50 and \$3 per day.  
TERRILL & INGERSOLL, Proprietors.

**FIFTH AVENUE HOTEL,  
Madison Square, New York.**

The largest, best appointed and most liberally managed hotel in the city,  
with the most delightful and central location. Conducted by HITCHCOCK,  
DARLING & CO., who first opened it to the public.

**THE WINDSOR HOTEL,  
DENVER, COLO.**

Largest and most Elegant Hotel in the West.  
BUSH & MORSE, Proprietors.

**ADAMS HOUSE,**

Washington-st., Boston.  
ON THE EUROPEAN PLAN.  
Three hundred rooms. Private parlors, baths, etc. Best location in the  
city. A strictly first-class house.  
GEO. G. HALL, Proprietors.

**YOUNG'S HOTEL,**

On the European Plan.  
Head of State-st., Boston.  
Greatly enlarged and improved, and now offers superior accommodations for  
both ladies and gentlemen. Noted for the peculiar excellence of its cuisine.  
J. R. WIRPPLE, Proprietor.

**TOWER HILL HOTEL  
AND COTTAGES.**

NARRAGANSETT PIER, R.I.  
Season 1889 opens June 25th.  
CHARLES A. DAKES, New York Office, 145 Broadway, Room 30.

The Oldest and Largest Roller Casting Estab-  
lishment in New England.

ESTABLISHED 1859

WILD & STEVENS,

MANUFACTURERS OF

Printers' Rollers and Roller Compositions,

No. 148 CONGRESS STREET, BOSTON.

WEBSTER

In various Styles of Binding, with and without  
Patent Index.

The Latest Edition has 118,000 Words, and 3,000 En-  
gravings,—3000 more Words and nearly 2000 more Engravings  
than found in any other American Dictionary. It also contains a  
**Biographical Dictionary**, giving brief facts concerning nearly  
10,000 Noted Persons. To these features we have

JUST ADDED (1885),  
A NEW PRONOUNCING

Gazetteer of the World,

containing over 25,000 Titles,

*briefly describing the Countries, Cities, Towns, and Natural  
Features of every part of the Globe.*

WEBSTER IS THE STANDARD

Authority with the U. S. Supreme Court and in the Gov't. Printing Office,  
and is recommended by the State Sup'ts of Schools in 36 States, and by  
the leading College Presidents of the United States and Canada.

THE LONDON TIMES says: It is the best Dictionary of the Language.

THE QUARTERLY REVIEW, LONDON, says: It is the best practical  
Dictionary extant.

THE CALCUTTA ENGLISHMAN says: It is the most important  
work of the kind.

THE TORONTO GLOBE, CANADA, says: Its place is in the very  
highest rank.

THE NEW YORK TRIBUNE says: It is recognised as the most useful  
existing "word-book" of the English language all over the world.

It is an invaluable companion in every school, and at every fireside.  
Specimen pages and testimonials sent prepaid on application.

G. & C. MERRIAM & CO., Publishers,  
Springfield, Mass., U.S.A.

Photo - Engraving.



Pen Drawing & Map Etching.

WHEN  
YOU \* ARE \* READY  
To order any more  
**BINDING**  
**PLEASE CALL UP**  
**TELEPHONE \* 230**  
Or send a POSTAL CARD to  
**JOHN LOVELL & SON,**  
23 & 25 St. Nicholas St., Montreal  
Best work at moderate prices.

## WHO SUBSCRIBE TO THE

## "INDEX OF CURRENT EVENTS."

The "Index of Current Events" is much appreciated not only by the press of Canada and the United States, but also by the public men of both countries. Its list of subscribers includes such great newspapers as the Philadelphia *Ledger*, the Boston *Transcript*, the New York *World*, the Cincinnati *Enquirer*, the Brooklyn *Eagle*, the Toronto *Empire*, the Cleveland *Leader*, the Chicago *Herald*, the Cincinnati *Post*, the New York *Morning Journal*, the Chicago *Daily News*, the Indianapolis *Journal*, the New York *Star*, the Troy *Budget*, the Chicago *Staats Zeitung*, the New York *Nation*, the Troy *Press*, the Washington *Star*, the Chicago *Inter-Ocean*, and many less known but important newspapers. Some of these papers are well known to keep admirable indexes of their own, yet find it advantageous to subscribe to the INDEX OF CURRENT EVENTS. We have the honor to include among our subscribers, Her Majesty's Privy Council for Canada; also, Sir John Macdonald, G. C. B. Premier of the Dominion, Sir Hector Langevin, Minister of Public Works, Sir A. P. Caron, Minister of Militia, the Hon. G. E. Foster, Minister of Finance, the Hon. Mackenzie Bowell, Minister of Customs, the Hon. J. A. Chapleau, Secretary of State, the Hon. John Costigan, Minister of Inland Revenue, the Hon. John Haggart, Postmaster, General, the Hon. John Carling, Minister of Agriculture, the Hon. C. H. Tupper, Minister of Marine and Fisheries, the Hon. Commissioner of Agriculture and Colonization Quebec, the Hon. Boucher de La Bruère, late speaker of the Legislative Council, Quebec, the Hon. Lieutenant Governor Royal, Mr. Erastus Wiman, the Hon. Minister of Public Works, Toronto. The Librarian of Parliament, the House of Commons Reading Room and the Librarians of many of the Provinces of the Dominion and States of the Union subscribe to the *Index*. Among the well known public librarians who subscribe are, Mr. J. C. Hurlbut, Librarian of the American Geographical Society, New-York, Mr. W. A. Bardwell, Librarian of the Brooklyn Library, Mr. W. H. Brett, Librarian of the Cleveland Public Library, Mr. F. P. Jordan, Librarian of the Public School Library, Battle Creek, Michigan, Mr. W. T. Peoples, Librarian of the Mercantile Library, New-York, Mr. Robert E. Rich, Librarian of the Public Library, Portsmouth, N.

H., Mr. J. P. Dunn, Librarian of the Indiana State Library, Indianapolis, Mr. F. W. Vaughan, Librarian of the Social Law Library, Boston, Mr. James G. Barnwell, Librarian of the Philadelphia Library, the Librarian of the Providence Public Library, the Librarian of the Free Public Library, San Francisco, Mr. John M. Doane, State Librarian of Ohio, Mr. William H. Egle, State Librarian of Pennsylvania, Mr. M. Chamberlain, Librarian of the Boston Public Library, Mr. A. W. Whelplay, Librarian of the Cincinnati Public Library and Mr. C. B. Tillinghart, State Librarian of Massachusetts. The leading bankers (including the Bank of Montreal), brokers, lawyers and hotel keepers of Canada, and many clergymen also keep the *Index* on file.

What is thought of the *Index* may be gathered from the numerous entirely unsolicited expressions of approval sent in by well known public men, of which the following are specimens:

MR. MARTIN J. GIFFIN, LIBRARIAN OF PARLIAMENT, OTTAWA, writes, I am sending you a subscription for two copies of your "*Index*," which will be most useful and which deserves encouragement. If you will take particular pains to give the dates and figures of elections and the dates of speeches of public men, with reference also to the place at which the speech was delivered, you will do a very grateful thing for public people and editors, and I may add librarians.

MR. JOHN M. DOANE, STATE LIBRARIAN OF OHIO, writes:—Enclosed please find six dollars, in payment for State Library subscription to the "*Index of Current Events*" for 1888.

I regard it as a very valuable publication, and hope that you may meet with such success as to warrant its continuance, for it will grow more valuable every year.

MR. HERRIES, OF THE BROOKLYN *Eagle*, writes:—"I congratulate you most heartily upon having done a good thing, a very good thing, in starting the "*Index*" enterprise. I hope I may have the joy of congratulating you upon your success a year hence. A man with *Index* on the brain is one after my own heart. My judgment was formed upon Number I; if the indexing is kept up as thoroughly in all subsequent numbers it will be a great help to us."

SIR CHARLES TUPPER, BART., HIGH COMMISSIONER FOR CANADA, writes:—It seems to me to be a very useful publication, and one that will be valuable for reference purposes."

MR. BURK, ASSOCIATE EDITOR OF THE PHILADELPHIA *Public Ledger* writes:—"Your *Index* is highly appreciated at this office, where it has long been a desideratum."

MR. COLQUHOUN OF THE "TORONTO *EMPIRE*," writes:—"Allow me to congratulate you most cordially upon your admirable *Index*. The idea and its execution are alike worthy of all praise."

MR. VADEN, OF THE "NEW-YORK *MORNING JOURNAL*," writes:—"I find the *Indices* of great value, saving, as they do, much valuable time in looking up important events."

MR. WILL A. WOODWARD, REC. SEC. MASS. PRESS ASSOCIATION, writes: Enclosed please find subscription for one year for "*Index of Current Events*." I have examined the specimen sent me with much interest and do not hesitate to commend it as an invaluable assistant in the newspaper office. The amount of time and labor it is calculated to save, cannot be compensated by one hundred times its subscription rate,

Commencing with Vol. II No. I the dates given in the *Index* are the actual dates of the occurrences; not as formerly the dates of publication.

The *Index* is published four times a month; but to form a complete file for the year it is necessary to preserve only the first issue in each month.

The immediate issues contain the news of the current month to date.

The subscription is \$6 per annum, payable yearly or half yearly in advance. Remittances should be made to

HENRY DALBY,

P. O. Box 864,

MONTREAL, Que.

# THE INDEX OF CURRENT EVENTS.

VOL. II. No. 28.

MONTREAL, AUGUST 8, 1889.

\$3.00 PER ANNUM.  
PUBLISHED WEEKLY.

## JULY

Abyssinia, Chief Debeb seized by Ras Aloula on going to a conference to which latter had invited him. Debeb's partisans join the force of King Menelik, advices received.—July 27.

ACCIDENTS.—Explosion, Munster, Westphalia, laboratory of Dr. Koenig, ether retort bursts, Drs. Fricke and Boemerhane fatally injured, and two others burned.—July 4.

Asphyxiation, Lincoln, Neb., four men lose their lives in a cesspool endeavoring to recover a watch.—July 17.

Balloon, Manchester, Eng., Lennox, assistant of Higgins, the parachutist, killed by collapse of balloon.—July 16.

Circus, Milford, Mass., seats at Bristol's circus give way, six hundred people fall with a crash, several persons injured.—July 17.

Cyclone, Hungary, Transylvania and Bukovina, cyclone sweeps over hundreds of persons killed, several districts completely ravaged.—July 28.

Drowning, Baltimore, steamer "Tolchester" strikes little boat in the harbor causing death to John Bietz, Mary Wiener and Mary Kall.—July 28.

Drowning, India, Laukhana, 40 persons drowned by flood.—July 9.

Drowning, Norway, Alcomnusse River, Miss Lizzie Farrell, Miss Anna McOlive of Glasgow, and Miss Alice McGilan, Eschbana, drowned by being swept over the Falls.—July 31.

Drowning, Ottawa, Joseph Loiven arrives on raft belonging to Caldwell & Co., from the Upper Ottawa, and reports six men drowned on journey.—July 17.

Drowning, Pittsburg, Pa., Red Pond, a body of water, at corner of Centre Avenue and Soho Street, sweeps barriers, drowning John Daly and Andrew McGregor.—July 11.

Drowning, Zanzibar, Dr. Schmeckopf, surgeon in chief of Capt. Wiseman's expedition, drowned.—July 27.

Electricity, Kingsville, Ont., governor on electric light machinery at Mattawa Hotel flies off and kills William Layman.—July 25.

Explosion, Anderson, Md., stick of dynamite fed into threshing machine, three men torn to atoms and their teams killed.—July 30.

Explosion, Hyeres, France, machine gun explodes on training frigate "Gouronne," eight persons killed and seventeen injured.—July 31.

Explosions, Pennsylvania, cave occurs in Hyde Park over vein of Central mine, followed by explosion, John Williams and Robert Roberts killed.—July 24.

Explosions, Port Blanchard, Pa., explosion of gas in shaft operated by Pennsylvania Coal Company, three miners burned fatally.—July 23.

Explosions, Ridgeway, Pa., explosion in grinding department of Eagle Valley tannery fires the building, one striker cremated, six others badly burned.—July 19.

Explosion, Topeka Pass, boiler of switch engine on Union Pacific Railway explodes, fireman James Dutton and engineer H. T. Secord fatally hurt.—July 16.

Falling building, Chicago, Cornelius Ferdinand, blacksmith, and family, and Charles Beck, laborer, and family killed by falling of building at corner of Oakley Avenue and Twenty-First street.—July 28.

Fires, Bakersfield, Cal., town nearly destroyed, loss \$1,250,000.—July 6.

Fires, Brocknaryville, Pa., Eagle Valley Tannery burned, and John Striker burned to death.—July 19.

Fire, Chicago, Anglo-American provision company's warehouse destroyed, six firemen overcome by smoke.—July 11.

Fires, China, Luchow, 8,000 dwellings destroyed, 1,200 persons perish in flames and 400 others killed, advices received at San Francisco.—July 23.

Fires, Constantinople, 200 houses destroyed.—July 18.

Fires, Durango, Colorado, almost totally destroyed.—July 1.

Fire, Fort Wayne, Mt., French brewery the property of C. L. Cantelver destroyed.—July 16.

Fire, Germany, Luemburg, loss of 12,000,000 marks.—July 1.

Fires, German, Ubenendorf, village of, destroyed by fire.—July 7.

Fire, Granville ferry, Annapolis, N.S., mill owned by Carribean & Co. destroyed, together with vessel alongside, Messenger's blacksmith shop and other buildings destroyed.—July 28.

## ACCIDENTS.—Continued.

Fires, Havre, France, shipyard of Abel and Lemarchant destroyed.—July 4.

Fire, Hungary, town of Paks, four hundred houses and public buildings destroyed.—July 21.

Fires, Jacksonville, Oregon, gaol containing 3 prisoners on fire, prisoners suffocated.—July 12.

Fire, Jonesburg, Mo., business portion of town destroyed.—July 3.

Fire, Koenigsberg, Germany, warehouses on docks along river Pregeel destroyed, also English steamer "Fortona."—July 12.

Fires, Lake, Ill., a residence fired by lightning and two other houses consumed.—July 19.

Fire, Lowell, Mass., stable of horse railway and other buildings burned.—July 17.

Fires, Ortonville, Minn., steamship "F. D. Underwood" destroyed.—July 13.

Fire, San Francisco, entire Chinatown district destroyed.—July 24.

Fires, San Lina, a village near Santiago de Cuba, sixty houses burned two children perish.—July 30.

Fires, Stoneham, Mass., boys start fire in a shed, deaf mute named Murphy burned to death.—July 21.

Fire, Wilmington, N.C., steamer "Queen of St. John's" burned.—July 10.

Flood, Japan, Chang Ping and Ping Yueng districts flooded by bursting of water spout, upwards of 6,000 lives lost.—2nd June, reported July 16.

Floods, Johnstown, many families flooded out.—July 2.

Floods, Johnstown, Coroner's enquiry into death of Ellen Hite, owners of Dam held responsible.—July 6.

Flood, Johnstown, N.Y., fifty persons drowned.—July 9.

Glacier Bay, Alaska, Bruce newspaper correspondent from Nebraska lost in a crevice. Consul Taylor of Winnipeg receives letter from Sitka informing him.—July 26.

Lightning, Kansas City, O'Connor Hannab, aged two years, killed by lightning.—July 15.

Lightning, Standing Rock Agency, N.W.T., two Indians Whitehorse and Black Eagle killed and others injured.—July 18.

Lightning, St. Hilaire, P.Q., Frel, Blomberg and Tummand Berg, Scandinavian farmers, killed.—July 3.

Mining, St. Etienne, France, three hundred miners entombed by explosion of fire damp.—July 3.

Poisoning, Burlington, Wis., nine persons poisoned by eating dried beef shipped to local dealers by a Chicago firm.—July 30.

Railway, Booneville, Mo., two heavy freight trains collide on Missouri, Kansas and Texas Railway, 150 head of cattle killed.—July 14.

Railway, Cinlinta, Servia, passenger train collides with freight train, fifteen persons killed and many injured.—July 9.

Railway, Chihuahua, 4 persons killed and 25 injured in wreck of train on Mexican Central.—July 8.

Railway, Flaxton, Surtch, Va., on New York and Western Railway, train wrecked by wash out, over thirty lives lost and nearly 100 persons injured.—July 2.

Railway, Germany, the Frankfurt express, through tumbler of switchman near Hochhausen, runs into open switch and into empty train, eight persons killed, and eleven injured.—July 7.

Railway, Greenfield, Ill., passenger train leaving Carrollton, Ill., at 3 p.m., wrecked, Miss Eva Davis of Carlingville, killed.—July 12.

Railway, Grenoble, France, passenger and freight trains on Paris, Lyons and Mediterranean Railroad collide, twenty persons killed or injured.—July 15.

Railway, Mount Carmel, Ill., passenger train on Cairo and Vincennes railroad completely demolished, twelve passengers seriously injured.—July 17.

Railway, Ogleton near Oxford, Ohio, fast passenger train leaving Hamilton at 7 a.m. going West collides with freight train going East, fireman Lee killed, others injured.—July 31.

Railway, Paterson, N.J., collision between freight cars and passenger train, fireman Joseph Gordon of Jersey City, killed.—July 12.



## ACCIDENTS.—Continued.

- Railway, Pittsburg, Pa., collision of gravel and coal trains on Pittsburg and Castle Shannon road, six persons injured.—July 10.
- Railway, Shamokin, Penn., train on Pennsylvania road carrying miners wrecked, John Roush and Aaron Shipe killed, twenty others injured.—July 17.
- Railway, Walls Station, Pa., second section of freight train wrecked by breaking of car axle, 13 cars burned, one tramp killed and five others injured.—July 8.
- Shipping, Augustine Creek, Savannah, Ga., steamer "St. Nicholas" runs into closed drawbridge, demolishing forward part of vessel, killing two women and injuring 28 men and women.—July 20.
- Storm, Titusville, Pa., much property destroyed.—July 3.
- Admiralty, British First Lord of Admiralty in House of Commons speaks as to the construction of warships during the present reign.—July 22.
- AFRICA.—African conference at Brussels initiated by England and Germany.—July 6.
- Zanzibar, Tippoo Tib and his son go to Saadani for purpose of bringing over his people who are being sold as slaves.—July 3.
- Zanzibar, Countess Blücher opens second Military hospital for treatment of German soldiers.—July 11.
- Pangani shelled by German gunboats, despatch from Zanzibar.—July 10.
- Tanga, German warships shell the town and land their men.—July 10.
- Tanga bombarded and occupied by Germans.—July 11.
- Official report of German military operations in published.—July 22.
- Zuit Graff, African traveller, arrives at Ibi on river Benue, advices received at New York.—July 23.
- Cape Town, United States Consul makes serious charges against Government of imprisoning American citizens.—July 29.
- Zanzibar, insurgents block the road to Nipwapwa. Three French mission runners killed while trying to get through rebel lines.—July 30.
- Air ship, Campbell's, Williamsburg, L.I., Prof. Hogan makes experimental trip and it vanishes in the clouds.—July 16.
- Air ship, Boston, association organized to assist Dr. A. De Bussel to construct steel air-ship upon the vacuum principle.—July 17.
- Airship, Prof. Hogan's, pilot boat "Robert Carll" signals the air-ship out at sea, Hogan picked up by an Atlantic vessel.—July 19.
- Alexandria Bay, riot caused by row between white man and colored waters.—July 18.
- Alien labor law, Chals, Mo., writ served on Henry F. and Charles H. Eaton, owners of America House.—July 17.
- Alien labor law, Alexandria Bay local authorities withdraw the enforcement of the law.—July 25.
- Allies, Chicago, City Council passes an ordinance depriving aliens of the right to serve the city in any capacity.—July 2.
- Altoona, Pa., waterspout does much damage.—July 2.
- American Salt Company, lists opened in London and New York.—July 22.
- Anarchists, International working people's association at New York celebrates party day.—June 14.
- Annexation, Canadian, Senator Wade Hampton interviewed at Washington.—July 25.
- Anthracite mines, near Banff, sold to English syndicate.—July 16.
- Astronomy, Comet, Prof. Brooks, director of Smith's Observatory, New York, discovers a new comet.—July 7.
- ASTRONOMICAL.—Brooks, Professor of Geneva, secures the first observation of his new comet in the constellation of the wheel.—July 22.
- Davidson of Queensland discovers a bright comet on July 21. Warner Observatory, Rochester, N.Y., receives a cablegram.—July 26.
- Augusta Princess, sister of the Queen of Denmark, death of.—July 16.
- Australia western, bill granting Home rule to, passed by British House of Lords.—July 11.
- Authors Society of, banquet at London, Eng.—July 3.
- Avon Valley, England, purchased by Wright, Butler & Co., of Manchester.—July 11.
- Banks, Bank of British Columbia, annual meeting at London.—July 18.
- Banka, Quebec, Union Bank, annual statement issued.—July 12.
- Baptist convention, Manitoba, elects J. W. Whitman of Emerson, president.—July 10.
- Havaria, Chamber of Commerce petitions Bismarck to bring about international agreement to prohibit any but cash transactions in coffee, sugar, etc.—July 26.
- Behring Sea, Sir Julian Pauncefote takes to England rough draft of an agreement between Great Britain and United States covering the Canadian and Behring Sea questions.—July 20.
- Behring Sea, American schooner "Rush" seizes British schooner "Black Diamond" in Behring Sea, British schooner "Triumph" brings news to Victoria, B.C.—July 28.
- Behring Sea, capture of "Black Diamond," steamer "Dora" brings first detailed news of capture to San Francisco.—July 30.
- Belgium, Chamber of Deputies, New Congo Railway. Two million dollars voted for.—July 23.
- Belgium, Senate sanctions credit asked by Government for Congo Railway.—July 27.
- Blythe Thomas II, the late, trial concerning property commences in Probate Court, San Francisco.—July 15.
- Biggell Mr. Frank, the pioneer, arrives at Quebec from Lako Abbitibi.—July 17.
- Boise City, Idaho, the constituted Convention unanimously passes the article on education and suffrage.—July 26.
- Boltman Charles A., naturalist of the National Fish Commission, dies in the swamps of Georgia.—July 1.
- Bookellers, London, Eng., Lumykin, Marshall & Co., Hamilton, Adams & Co., and W. Kent & Co., amalgamate forming limited liability company.—July 24.
- Braidwood, Ill., great distress at, 3,000 people homeless and starving.—July 1.
- Brakeman, Brotherhood of American and Canadian, in session at Ottawa.—July 25.
- Brazil, Government of, appoints commission to the International Congress to be held at Washington.—July 29.
- Brazil, Emperor shot at theatrical performance at Rio Janeiro by a Portuguese.—July 10.
- Brazil, Consul Armstrong at Rio Janeiro, in report to State Department at Washington, says Brazil is anxious to secure in United States a market for its sugar.—July 20.
- Breweries, Denver, Col., two of largest breweries purchased by the syndicate.—July 8.
- Brewers who have not sold out to English Syndicate reported in New York to be combining to protect themselves against the Syndicate.—July 22.
- Breweries, Paterson, N.J., English Syndicate purchases five of the six breweries for \$2,380,000.—July 25.
- Breweries, Omaha, negotiations completed for sale of all the breweries to European Syndicate for \$1,500,000.—July 31.
- Bribery, San Francisco, Creighton D.J., ex-State Senator convicted of jury bribery two years ago, arrives at San Francisco and surrenders to the police.—July 15.
- British Columbia, Board of Trade at its annual meeting decides in favor of reciprocity.—July 10.
- Brotherhood of American Railway Brakeman of Canada and United States in session at Ottawa.—July 27.
- Butler Gen. H. F., speaks at Colby College, Waterville, Me., on annexation.—July 3.
- Canadian Anthracite Coal Company's land, reported sale of, to British syndicate confirmed.—July 15.
- Canadian convention, New York.—July 2.
- Canadian Electric Gas Improvement Company of Halifax, N.S., seeks incorporation.—July 19.
- Canadian Press Association, annual meeting at Toronto.—July 18.
- Railways, Emperor decides to issue edict for construction of Lungchow railway, Marquis Tseng appointed general director of Chinese railways.—July 15.
- Canadian Syndicate to secure mineral and other properties in Canada registered in London, Eng.—July 8.
- Canmore, B. C., Government decides to lay out town site at Canmore, B.C.—July 22.
- Cardiff, Glastone Mr. W. E., presentation of freedom of city of.—July 6.
- Catasauque Manufacturing Company, Allentown, Pa., wages of employees increased 10 per cent.—July 6.
- Cattellier Mr. L. A., appointed Canadian Under-Secretary of State.—June 13.
- Central Nail Company of Wheeling, West Va., chartered.—July 29.
- Chickasaw, Indian nation, cowboys on cattle ranch of Mrs. Criter raid sheep ranch of Mexican, killing several hundred sheep. Desperate light expected, several marshalls gone to arrest perpetrators.—July 12.
- Chicago, aliens, City Council passes ordinance depriving aliens of the right to serve the city in any capacity.—July 2.
- China, Yellow river bursts its banks in Syan Tung, loss of life and property incalculable.—July 26.
- Cholera Asiatic, Philippine Islands, Department of Agriculture, Ottawa, apprised of an outbreak.—July 26.
- Cholera, Asiatic, Waverly, Ohio, case reported there by two doctors.—July 2.
- Cholera morbus, Johnstown, Pa., epidemic of.—July 4.

Churchill Lord Randolph, Walsall, speaks on the results of the bye elections.—July 29.

Churchill Lord Randolph make socialist speech at Walsall.—July 30.

Churchill Lord Randolph speaks at Birmingham, and recommends as final solution of Irish question an Imperial loan of £100,000,000, to enable tenants to buy their holdings.—July 30.

Clan-na-Gael, Joseph Medhill of Chicago writes Earl of Aberdeen, refuting the London Times' insinuation that signers of Illinois addresses to Mr. Gladstone were Irishmen members of Clan-na-Gael.—July 18.

Clan-na-Gael, New York, members of Cronin faction hold secret session in Vanderbilt hotel.—July 21.

Clan-na-Gael, Luke Dillon returns from New York to Philadelphia, having failed to induce Sullivan members to agree upon date for convention or upon successor to Patrick Egan.—July 23.

Coal, Anthracite, report of sale of Canadian Anthracite Coal Company's land to British syndicate confirmed.—July 15.

Coal, Truro, N.S., two seams of good hard coal discovered within six miles of Truro.—July 29.

Columbus Christopher, number of his papen petition the Vatican to canonize, on anniversary of discovery of America.—July 9.

Comet, Prof. Brooks, director of Smith's Observatory, New York, discovers a new comet.—July 7.

Common scold, Jersey City, Brady Mrs. Mary, convicted of being.—July 10.

Confederates, National Association of, meets at Chicago and offers a reward for detection of adulteration.—July 2.

Congo, telegram from Governor General of Congo states that English steamer "Loulaba" from Liverpool ascends the Congo as far as Matadi.—July 4.

Consular U. S. appointments, Goode E. C., of Maine to St. Stephens, N.B., and A. D. Sumner of Kansas to St. John, N.B.—July 1.

Contract labor law, New York, Secretary Windom rejects the offer to compromise the judgment against Holy Trinity church, New York.—July 2.

Contract labor law, Secretary sent over by English firm to take the place of an American in its branch house at New York, Secretary of the Treasury decides he must return to England.—July 27.

Contract labor law, acting Secretary of Treasury department, Washington, writes Collector of Customs at Cape Vincent, N.Y., to be cautious in administering the law.—July 28.

Curea, Gibson-Heron, wife of Rev. David Gibson-Heron, falsely reported to have been sentenced to death for teaching doctrines of christianity.—July 23.

Costa Rica canal trouble, despatch from Panama says Costa Rican troops marching on Nicaragua.—July 4.

Costa Rica and Nicaragua, Senor Zeledon, Minister from Costa Rica to United States, lives at Washington, and denies reports of trouble over Nicaragua.—anal.—July 9.

Cotton Manufacturers, representatives from Lancashire and Yorkshire meet at Manchester and decide to run on half time for one month.—July 12.

Cotton Spinners, Council of United, Manchester, meets and resolves all spinners to reduce their production by one half for a month.—July 9.

Cotton, Texas cotton crop, first bale of this year's crop reaches Houston, Texas.—July 23.

Cotton Spinners, England, two-thirds reach an agreement to run on half time for a month.—July 26.

Crete, Russian cruiser ordered to.—July 12.

Crete, three British men of war ordered to.—July 13.

Crete, Turkey prepares to send several battalions to, in consequence of threatened rising of the people.—July 20.

CHETE.—Insurgents seize the towns of Namos and Cidonia.—July 22.

Risings threatened at Sphakia, Retimo, Nalata and Sidera.—July 26.

The Turkish Council decides not to send a squadron to Crete nor to take active measures for the repression of the revolt.—July 27.

Turkish Government resolves to send new commission to, also eight battalions of troops.—July 30.

Two French men-of-war ordered to proceed to.—July 30.

Turkish Governor M. Sartnisky recalled.—July 30.

M. Spuller, the French Minister of Foreign affairs, intimates to M. Delyanne, the Grecian Minister to France, that France is disposed to support solution of Cretan crisis in favor of Greece.—July 31.

Muslimans burn over a hundred houses in a village near Cairn. The insurgent leaders have appealed to Greek for assistance.—July 31.

Whole island said to be in revolt with all the principal towns in full possession of the insurgents.—July 31.

CRIMES.—Bigamy, Charlotte, N.C., Isabella Davis arrested for living five husbands.—July 4.

Abseonders, Chippewa Falls, Wis., Newald L. J., well known dealer in horses, disappears with \$70,000.—July 10.

Abseonders, Colebrook, N.H., Williams Elmon H., disappears, leaving \$80,000 worth of acceptances behind him.—July 10.

Abseonders, Kansas City, Mo., Polster E. B., lessee of the Terra Cotta Lumber Company's plant, goes to Canada leaving his accounts \$30,000 short.—July 23.

Abseonders, Montreal, Narbonne Napoleon, accountant of Water department.—July 10.

Abseonders, Wichita, Kas., Paul Edward, cashier of Pacific Express Company, disappears.—July 16.

Boodler, Ballston Spa, N.Y., session of Court of Oyer and Terminer for trial of ex-Ald. Arthur McQuade of New York.—July 9.

Boodlers, Ballston, N.Y., McQuade trial, jury return verdict of not guilty.—July 19.

Counterfeiters, Dayton, Ohio, dangerous gang unearthed at.—July 18.

Counterfeiters, Juarez, Mexico, nest of counterfeiters broken up.—July 13.

Defaulters, Malta, Ohio, H. Miller, cashier of Malta National Bank.—July 6.

Defaulters, Watertown, N.Y., Postmaster Quency gives bonds to appear at United States court to answer for shortage discovered in his accounts.—July 13.

Embezzlers, Kansas, George Fowle & Son, packers, discover that for two years they have been robbed by certain employees.—July 12.

Embezzlers, Hoboken, N.J., Hoyt Frank, paying teller of First National bank, arrested for embezzling \$15,000.—July 5.

Forgery, Ottawa, Cornellier L. C., of the Public Works department, arrested on charge of forging cheque for \$55 in the name of Deputy Minister Bailarge.—July 31.

Fraud, London, Field Major T. M., assistant secretary of the British and American Mortgage Company, arraigned and remanded to prison for fraudulently issuing coupons of the company.—July 11.

Poisoning, Toronto, Sbrling Horace, arraigned for poisoning his father, mother and sister.—July 16.

Robbery, Milwaukee Post office, extensive thefts of registered letters reported.—July 20.

Shooting, New York, Frank Myers, Edward Fanning and James Egan, longshoremen on Ocean Steamship company's wharf, shot by an unknown person while at work.—July 16.

Stabbing, Fergus, Ont., Miss Ellis stabbed by Patrick Haley in township of Garafraxa.—July 31.

Customs, Canadian, Montreal Transportation Company's steamer "John Gaskin" of Kingston seized for having repairs done in United States and not reporting to Customs.—July 16.

Customs, Canadian, steamer "Emete" of Boston seized for landing liquors without reporting at Campobell, N.B.—July 16.

Customs, Canada, Wolfe Islanders, Ont., cattle seized that were kept in United States during the winter.—July 6.

Customs, U. S., contract labor law, Acting Secretary of Treasury department, Washington, writes Collector of Customs at Cape Vincent, N.Y., to be cautious in administering the law.—July 28.

Customs, United States, taxing Canadian cars, Treasury Department, Washington, decides that cars should pay duty, except when engaged in transporting Canadian goods into United States.—July 27.

Cyclone, Long Island, Ont., Hervey's new summer hotel destroyed.—July 9.

Davenport, Ia., Rev. Monroe Drew, Presbyterian minister, compelled to leave the city.—July 14.

DEATHS.—Goodyear Archdeacon, of East Africa missions, at Magila.—July 3.

Augusta Princess, sister of the Queen of Denmark.—July 16.

Bois Rev. Father, curé of Maskinongé.—July 9.

Boltman Charles A., of the National Fish Commission, in the swamps of Georgia.—July 15.

Coreoran Very Rev. James A., at St. Charles Borromeo Seminary, Overbrook, Pa.—July 16.

Danaher Rev. Father, parish priest of St. Joseph's, Halifax.—July 24.

Emerson Hon. G. H., death of, in Newfoundland.—Reported July 20.

Faure Rev. Father, parish priest of Massiam, Ottawa.—July 15.

Harel Rev. Abbé Telesphore, DD., chancellor of the Archbishop of Montreal.—July 18.

Jones Mr. W. C., editor of Paris, Ont., *Star Transcript*, death of.—July 6.

Jung Sir Sahar, Mizam of Hyderabad.—July 7.

Lewis Rev. W. T., at Springfield, Ohio.—July 16.

Mason Dr. C. C., Grand Commander of Knights Templar of California.—July 15.

Morse Mrs. Johanna S., connected with the Beecher-Tilton scandal, dies at New York.—July 27.

## DEATHS.—Continued.

Mother Theresa, head of the order of our Lady of Loretto at Toronto.—July 1.

Narquay Hon. Mr., ex-premier of Manitoba, death of.—July 6.

Pardoe Hon. T. B., late Commissioner of Crown Lands for Ontario, dies at Barrie, Ont.—July 21.

Pie General W. A., at Mouravia, Ala.—July 7.

Prince Nicolas of Mingrelia, formerly candidate for Bulgarian throne death of in the Caucasus.—July 9.

Pugh, Eliza Loftin Phillips, litterateur, wife of W. W. Pugh, Jun., of New Orleans.—July 29.

Seymour Fred. J., manager of American Aluminum Company, a Findlay, Ohio.—July 13.

Smith Egbert tangiers, at Patchogue, L. I., large land owner.—July 7.

Tye James O., publisher and proprietor of Watford *Guide Advocate*, dies at Watford, Ont.—July 30.

Tyler Mrs., wife of ex-President John Tyler, at Richmond, Va.—July 11.

Watrous Hon. Geo. H., ex-president of New York, New Haven and Hartford Railway, at New Haven, Conn.—July 5.

Woolsey, ex-President, of Yale College.—July 2.

Diphtheria, Salem, Mass., epidemic at.—July 3.

Diphtheria, St. John's, Nfld., epidemic abates.—July 6.

DIPLOMATIC.—U. S. and Hayti, Douglass Frederick, appointed to be Minister resident and Consul General of United States to Hayti.—July 1.

Disappearance, Toronto, Bowden Wm., of Grand Trunk Railway.—July 25.

Distillery, Blue Island, British Syndicate in Chicago purchases land, buildings and brick belonging to Wahl Bros., to convert same into model distillery.—July 18.

Divorce, Chicago, Carter divorce case, motion for new trial overruled.—July 15.

Divorce, Chicago, Mary Goltschalk, resident of Pennsylvania, obtains divorce from her husband.—July 24.

Divorce, Ottawa, notice of application by Emily Walker, of Hamilton for annulment of marriage with Alfred Percy Walker, on the grounds that at the time of marriage they were both minors.—July 16.

Divorce, San Francisco, Cal., new trial in the Sharon divorce case refused in Supreme Court of California.—July 17.

Dogs, Kennel Club, London, rules if ears cut, dog not eligible for show.—July 11.

Dominion Millers Association, Toronto, annual convention opens.—July 9.

Duel, Astoria, Oregon, John Bolot and John W. Lucas fight duel with pistols, Lucas receives fatal wound.—July 2.

Earthquake, Arran, Island of, shock felt.—July 17.

Earthquake, Farmington, Me., shock felt at.—July 7.

Earthquake, Japan, Island of Kiu Siou, dreadful earthquake, town of Kumamoto destroyed.—July 29.

Earthquake, Memphis, Tenn., slight shock felt.—July 19.

Earthquake, Russia, town of Djarkene in Semiretinsk, one half of town destroyed.—July 12.

Earthquake, Russian province of Prievalsk destroys 167 houses and wipes out a village.—July 30.

Earthquake, San Francisco, heavy shock felt at.—July 31.

ECCLESIASTICAL.—Africa South, Goodyear Archdeacon, death of, at Magiba.—July 3.

Baltimore, Roman Catholic prayer book authorized by third plenary council, completed and placed in hands of publishers.—July 7.

Biddeford, Me., Barrington Rev. Father, assistant priest of St. Mary's church, arraigned in Municipal Court, charged with assault and battery.—July 30.

Columbus Christopher, Bishops and others petition the Vatican to canonize, on anniversary of discovery of America.—July 9.

Contract Labor Law, New York, Secretary Windom rejects the offer to compromise judgment against Holy Trinity Church.—July 2.

Corrigan Archbishop, summoned by Pontiff to Rome, *vide Ro* re correspondent of *The Times*.—July 1.

Davenport, Ia., Rev. Monroe Drew, Presbyterian minister, compelled to leave the city.—July 14.

Germany, Empress Augusta Victoria joins the Roman Catholic church.—July 13.

Halifax, Danaher Rev. Father, parish priest of St. Joseph's, dies.—July 24.

Jerusalem, Mgr. Fava, Bishop of Grenoble, France, accepts Pope's offer of Patriarchate of Jerusalem.—July 23.

Kingston, Ont., Presbytery of, elects Rev. M. W. Maclean moderator.—July 3.

## ECCLESIASTICAL.—Continued.

London, Eng., Wesleyan conference, opening of.—July 23.

Manitoba Baptist convention, Rev. J. W. Whitman, of Emerson, elected president.—July 10.

Manitoba, First assemblage of the Catholic clergy of the Ecclesiastical province held at St. Boniface.—July 16.

Masham, Ottawa, Faure Rev. Father, parish priest, dies.—July 15.

Maskinongé, P. Q., Abbé Bois, death of.—July 9.

Montreal, Harel Rev. Abbé Telephore, DD., chancellor of the Archbishop of Montreal.—July 18.

Nashville, Tenn., Kean Bishop, rector of Catholic University at Washington, interviewed as to Pope's probable successor.—July 17.

New York, Archbishop Corrigan summoned to Rome to explain his conduct, see *New York Press*.—July 17.

Ottawa, Lutheran Synod, Canada, district of, concluded at.—July 31.

Ottawa, P. Q., Corcoran Very Rev. James A., dies at St. Charles Borromeo Seminary.—July 16.

Philadelphia, Sherman Thomas Ewing, son of General Sherman, receives final orders of the priesthood.—July 7.

Rome, Pope receives the Spanish ambassador and alludes to his possible departure from Rome.—July 1.

Rome, the Pope in a secret consistory refers to Premier Crispi's speech.—July 1.

Rome, Cardinal Lavergie selected by Pope as his successor *vide* Rome correspondent *Independence* Belge.—July 6.

Rome, Pope gave a four hours' reception to Cardinals and Diplomats at Rome.—July 15.

Springfield, Ohio, Lewis Rev. W. T., death of.—July 16.

Toledo, Ohio, suspension of Rev. Dr. Quigley, formerly of St. Francis de Sales church, by Bishop Gilmour, of Cleveland, not approved at Rome.—July 25.

Toronto, Bishop Walsh, of London, Ont., elected at Rome Archbishop of Toronto.—July 24.

Toronto, Mother Theresa, head of the order of our Lady of Loretto at Toronto, death of.—July 1.

World's Sunday School Convention opens in London, Eng.—July 2.

Edinburgh, city of, freedom of city conferred upon Mr. C. S. Parnell, M. P.—July 20.

EGYPT.—Arquin, engagement takes place between force of Egyptian troops under command of Col. Wodehouse and a body of dervishes.—July 2.

Arbu, Sibel, pass, Egyptian troops under Colonel Wodehouse occupy pass and check march of the Dervishes.—July 13.

English and Egyptian troops sent to drive the dervishes beyond the frontier, four field guns sent to Assouan.—July 11.

Frontier, British government taking measures to protect, statement by Mr. Stanhope in British House of Commons.—July 10.

Grenfell Gen., arrives at Assouan, sheiks have expressed loyalty, Egyptians capture Bimban, Egyptian picket kills eleven dervish foragers.—July 10.

Khartoum, news from, received 4 Assouan from Dervish prisoners, five nuns and two priests reported alive at Khartoum.—July 12.

Official estimate of the number of the invaders under Nad-el-Imia given by Mr. Stanhope in British House of Commons.—July 11.

Pangani, Wissmann Capt., attacks Arab forces at, despatches received at Zanzibar.—July 9.

Soudan, Col. Wodehouse's cavalry occupy camp of enemy and find it deserted, sharp engagement with the Dervishes follows, advices received at Cairo.—July 9.

Three battalions of British infantry and squadron of Hussars ordered from Cairo to Assouan.—July 9.

Wodehouse Col., commander of Egyptian troops, sights dervishes moving northward from Arquin.—July 7.

Col. Wodehouse telegraphs he is gravely hampered by prisoners. Two guns taken abandoned by Dervishes.—July 15.

Advices from front state General Grenfell has assumed command.—July 16.

Gen. Grenfell sends messengers to Nad-el-Jumi, with proclamation, summoning him to surrender; the messengers beaten, and Nad-el-Jumi reads proclamation to assembled Dervishes.—July 16.

Government notifies French Government that latter's refusal to accept the conversion scheme will cost Egypt yearly £200,000.—July 18.

Gen. Grenfell's despatch containing reply of Nad-el-Jumi to the general's demand for surrender read in British House of Commons.—July 18.

Assouan, eight hundred more British troops start for.—July 20.

Reconnoitring party sent out from Wady Halfa find Dervishes under Nad-el-Jumi occupying good position.—July 20.

Conversion scheme, French government gives final refusal to assent to.—July 20.

Advices from Assouan say re-inforcements have been summoned to Khartoum and Dongola.—July 22.

## EGYPT.—Continued.

British forces shell the Dervish camp.—July 28.  
Cairo, advices from the front state that three columns of Dervishes marching to reinforce the rebels.—July 26.  
Nad-el-Imin leader of the Dervishes, strikes camp and resumes his march northward.—July 27.  
Wiseman Capt., offers reward for capture of Chief Iushri, who murdered Nielsen, officer of East Africa Company.—July 27.  
Dervishes who occupied village of Toski driven out by Egyptians leaving the bodies of 34 of their numbers. Number of Dervishes captured, Col Wodehouse's report received.—July 31.  
Toski, advices from, that Lieut. Dagular, with detachment of Egyptian cavalry and Company of 11th Sudanese regiment defeat Dervishes south of Anabi.—July 31.

ELECTIONS.—France, Boissay, St. Legre, Gen. Boulanger elected District Councillor.—July 2.  
Carmarthenshire, Morgan Mr., Gladstonian, returned to British House of Commons.—July 17.  
Dover, Eng., Wyndham Mr., returned unopposed.—July 12.  
France, Boulanger, Dillon and Rochefort issue manifesto to electors.—July 21.  
France, Boulanger only carries twelve cantons out of 451 contested.—July 28.  
Metz, Father Dolles, a Catholic, and member of the Protester, party elected member of the Reichstag.—July 25.  
Marylebone, Boulnois Mr., Conservative, returned to British House of Commons.—July 19.

Electricity, Edison's Patents, Ottawa Minister of Justice grants the application of Edison's solicitor for a rehearing of decision of Mr. Pope cancelling Edison Patents.—July 23.  
Electricity, execution by, Kemmler case, New York, Thomas Edison gives evidence.—July 23.  
Electricity, executions by, Kemmler reference, New York, electrical subway, commissioner Edison, John W. Noble and Alexander McAddie give evidence.—July 15.  
Electricity, executions by, Kemmler case, Peterson Dr. Frederick, gives evidence.—July 16.  
Electricity, executions by, Kemmler case, Gerry Elbridge T., gives evidence.—July 17.  
Electricity, Niagara Falls, Col. Hamilton obtains grant from Ontario Government to set up electric generating machine under the Falls.—July 20.  
Elopement, Abbeville, Ala., Holland Mrs. Lillie G., elopes with Charles Lee, a negro.—July 17.  
Emerson Hon. G. H., death of, in Newfoundland.—Reported July 20.  
Esquimaux, Vancouver Island, Theodore Cramp, of Philadelphia shipbuilding firm, forms syndicate of American capitalists to buy British Naval station.—July 23.  
Evanson, Wyo., Lewis John, a wife beater, thrashed by women.—July 16.  
Evansville, Md., severe storm, many persons injured by electricity.—July 14.

Failures, Boston, Batchelor Messrs. E. and A. H., large boot and shoe house, liabilities \$1,250,000.—July 30.  
Failures, Chester, Pa., The Yeoman mills; Bancroft's Bank, Todmorden Mills; Philadelphia, mills of Schenker's Bros., all in consequence of failure of Lewis Bros. & Co.—July 29.  
Failures, Georgetown, Del., Treat C. P. & Co., and C. H. Treat Manufacturing Co., with liabilities \$100,000.—July 13.  
Failures, Lynn, Mass., The L. A. May Co., large furnishing and plombling establishment, assigns.—July 27.  
Failures, Lynn, Mass., Roberts Oliver S., proprietor of Trotting Park at Sangus, Mass.—July 28.  
Failures, Milwaukee, Wis., Burton John E., known as the Gogebic Iron King, assigns, liabilities \$825,000.—July 16.  
Failures, New York, Lewis Bros. & Co., dry goods.—July 24.  
Failures, Philadelphia, National Bureau of Engraving, two hundred hands employed at works at Burlington, N.J., discharged.—July 30.  
Failures, Philadelphia, Pa., Lewis Brothers & Co., dry goods merchants of Chestnut street, assigns.—July 25.  
Failures, Providence, R. I., Richmond Paper Co., suspends.—July 26.  
File Earl of Dukedom conferred on, by the Queen.—July 18.

Fishing, Bay of Quinte, order-in-council prohibiting net fishing amended so as to allow net fishing on the Bay from Deseronto eastwards.—July 20.

Fisheries, Canada, Government upon recommendation of Minister of Marine and Fisheries decides to send experts to fishing stations of Scotland and Holland, for purpose of examining and reporting on herring fishing industry.—July 6.  
Fisheries, Canada, "Mattie Winship" seized off Sydney, C.B., for illegal fishing, Governor-General approves recommendation of Minister of Fisheries for settlement.—July 23.

Fisheries, Cape Breton Coast, Department of Justice receives intimation from owners of the seized "Mattie Winship" of Gloucester, Mass., that no defence can be offered.—July 12.  
Fisheries, North Atlantic, Sir Julian Pannocofe interviewed as to reopening negotiations at Washington.—July 7.  
Fisheries, protection service, Minister of Marine and Fisheries decides upon scheme for its reorganization in Nova Scotia and New Brunswick.—July 26.  
Fisheries, Behring Sea, American schooner "Riah" seizes British schooner "Black Diamond"; in Behring Sea; British schooner "Triumph" brings news to Victoria, B.C.—July 28.  
Fisheries, Coo Bank, Fish Commission at Washington advised of discovery of Coo bank on the Pacific, eight miles off Nestucca, Oregon.—July 27.

Fish, French fishermen of St. Pierre, Miquelon, Dominion Government decides to withdraw privilege of landing fish at Halifax, and re-packing in bond.—July 29.  
Fisk Henry C., of Vermont, appointed U. S. Consul at St. Johns, Quebec.—July 20.

Floods, Columbus, Texas, Colorado river inundates district and entirely destroys crops.—July 18.  
Floods, Milk River valley, Mont., from Assiniboine to near Chinook.—July 18.  
Foreign labor contract law, Lubeck, Maine, Canadians working in sardine canning factories compelled to leave.—July 12.

FRANCE.—Bissez, St. Legre, Boulanger Gen., elected District Councillor.—July 2.  
Boulanger, A. M. de Beaurepaire, Procureur-General, refuses to prosecute Boulanger for corruption, and resigns.—July 5.  
Boulanger Gen., copy of indictment formally delivered at his residence in Paris.—July 10.  
Boulanger Gen., issues manifesto from London, stating he will present himself for election in eighty cantons.—July 19.  
Boulanger, forty journals sentenced to pay nominal fines for publishing the indictment against.—July 24.  
Boulanger, time granted to answer summons of Senate Court having expired, official publicly reads before his residence a decree giving him ten days in which to appear before the Court.—July 28.  
Boulanger, Henri Rochefort announces Boulangist committee will pay full salary to officials dismissed from Government employ for adherence to Boulangist principles.—July 23.  
Cabinet decides to have remains of Carnot, Marceau and Beaudin transferred to the Pantheon on August 4.—July 9.  
Celle, re-ballot for municipal officers, socialists gain victory over Boulangists.—July 7.

Chamber of deputies, Boulangist journals libel Tierset and Rouvier, motion strongly ensuring the offending journals carried.—July 2.  
Chamber of deputies, secret service fund abolished.—July 3.  
Chamber of deputies, heard discussion on the charge of bribery against M. Rouvier, Minister of Finance.—July 3.  
Chamber of deputies, army bill compelling seminarists to undergo years military service, Senates amendments to, agreed upon.—July 8.  
Chamber of deputies, Admiral Krantz, Minister of Marine, declares the need of several new warships.—July 9.  
Chamber of Deputies, Telephones bill for purchase of, adopted.—July 10.  
Chamber of deputies, M. Laguerre creates another disturbance while dissenting recent arrest of Boulangists at Angoulême.—July 11.  
Chamber of Deputies, M. Thomson, member for department of Constantine, Algeria, in the lobby, strikes M. Laure; Laure challenges Thomson to fight a duel.—July 12.  
Chamber of Deputies, M. de Herize refused permission to continue his speech on the arrest of Boulangists at Angoulême.—July 12.  
Chamber of Deputies, charge against M. Constans, Minister of Interior, of corruption and dishonesty while Governor of Indo-China, motion of impeachment by M. LaMarinière rejected.—July 12.  
Chamber of Deputies, bill providing no one shall be allowed to count more than one seat at same time passed.—July 13.  
Chamber of Deputies, Budget committee, votes to recommend to the Chamber a measure empowering the Government to purchase Millet's picture "L'Angelus."—July 13.  
Chamber of Deputies passes Amnesty bill and closes session.—July 15.  
Chamber of Deputies approves bill providing for credit of 58,000,000 francs for building warships.—July 15.  
Chamber of Deputies, M. Proust, withdrawal of request for a credit for the purchase of Millet's "Angelus."—July 16.  
Communists, Marxists march in procession to the cemetery Père La Chaise, and lay wreaths upon the graves of dead communists.—July 21.

Egyptian conversion scheme, government gives final refusal to assent to.—July 20.

## FRANCE.—Continued.

Elections, Boulanger, Dillon and Rochefort issue manifesto to electors.—July 21.

Elections, Boulanger only carries twelve cantons out of 451 contested.—July 28.

Exhibition, German officers forbidden by Emperor to visit.—July 9.

German buying of meat in French markets, Government takes measures to prevent it.—July 1.

Goblet M., formerly French Minister of Foreign affairs, in address at Government clerks receive notices of dismissal, for congratulating Boulanger.—July 15.

Lille, declares that Boulangism in no way endangered the Republic.—July 7.

High Court recommends that Boulanger, Dillon and Rochefort be arraigned on charge of conspiracy against the State. See Paris *Journal des Debats*.—July 11.

Krantz Admiral, Minister of Marine and Colonies, demands from French chamber of deputies extra credit of 60,000,000 francs for navy.—July 6.

Minister of War orders Col. Vincent to be placed under arrest, for publishing evidence given in Senate Court in Gen. Boulanger's case.—July 16.

Olivier Emile, publishes letter denouncing indictment of General Boulanger.—July 18.

Paris, Boulangist meeting on Place de la Concorde, before the statue of Strasbourg dispersed.—July 14.

Paris, one hundredth fall of Bastille celebrated.—July 14.

Paris bars suspende, Mr. Laguerre, Boulangist deputy, for libelling Do Beaurepaire, the Procureur General.—July 3.

Paris, manager of *Intransigeant* sentenced to imprisonment because of paper's personal attacks on the Procureur General.—July 8.

Paris Exhibition, bull fights stopped by the police.—July 9.

Paris, review of troops held by President Carnot at Longchamps, Paris.—July 14.

Paris, Secretan sale.—July 1.

Paris, Secretan sale concluded.—July 4.

Paris, Liberty Statue, unveiling of, President Carnot.—July 4.

Paris, Shah of Persia arrives at.—July 30.

Police search the offices of the *Cocarde*, and the residence of the editor, who is arrested.—July 27.

Pont L'Abbe, Finisterre, M. Dupret, a Boulangist deputy, who attempts to make a speech, attacked by a mob and stoned.—July 23.

Russia, a definite, offensive and defensive alliance concluded, see Vienna *Allgemeine Zeitung*.—July 29.

Seditious assemblies, M. Constans, Minister of the Interior, decides to form new body of police, consisting of 100 men to suppress seditious assemblies.—July 21.

Senate, remains of Carnot, Marceau and Baudin, bill to transfer to Pantheon adopted.—July 1.

Senate, Panama Canal Co. committee approves bill for relief of.—July 6.

Senate, Panama Canal relief bill adopted.—June 11.

Senate, Budget debate on, continued, during the debate Baron Delariny and Senator Lelièvre become involved in quarrel.—July 11.

Senate adopts budget and closes session.—July 15.

Fraserville Shue factory, Quebec, sold by auction.—July 3.

Gambling, Long Branch, N.Y., George Law duped out of \$30,000, at Daly's gambling house.—July 11.

Gas, Indiana, syndicate formed, which secures gas rights of, between 50,000 and 60,000 acres, and will pipe the gas to Chicago.—July 30.

Gas Companies, Brooklyn, N.Y., English syndicate buys controlling interest in three gas companies.—July 20.

Gas, Ruthven, Ont., well of Natural Gas set alight.—July 9.

Gas trust, Chicago, English syndicate endeavoring to purchase gas trust's plant.—July 12.

Georgian Bay, three men lose their lives while going to a lumber camp, discovered by Detective Irving of Sunbury, Ont.—July 12.

GERMANY.—Kiel Tribunal dismisses suit of Prince Christian of Schleswig for restitution of family estate.—July 3.

Army, Government decides to ask for extra credit for the army, to be devoted exclusively to Artillery branch of the service.—July 30.

Berlin, News of the Czar's assent to the proposal he should visit the German Court, on August 23rd, received at the Foreign office.—July 22.

Braunfels, monument to late Emperor Frederick unveiled.—July 17.

Berlin, police deliver an student suspected of being a Nihilist to Russian authorities.—July 19.

Berlin, Empress Augusta, joins Roman Catholic Church.—July 13.

Officers of German army forbidden by Emperor to visit French Exhibition.—July 9.

Gladstone Mr. W. E., Cardiff, presentation of freedom of city.—July 6.

Gladstone H. Hon. W. E. and Mrs., celebrate their golden wedding in London.—July 25.

Gladstone Mr. and Mrs. W. E., golden wedding. Reception at National Liberal Club.—July 20.

Glass Bottle Manufacturers, Eastern Association of, semi-annual meeting held at New York, demands of workmen regarding wages and limitation of apprentices not entertained.—July 18.

Gold, New York, bar to the amount of a million pounds ordered for shipment to Europe.—July 18.

Grand Forks, Dak., Alderman Ryan tried for fraud in miscounting ballots for Martin Walsh, superintendent of the Water Works.—July 15.

Guinea Upper, English remove the French flag from house of Sultan Bomitonkon at Grand Bassam, Upper Guinea.—July 3.

Hampton, Senator Wade interviewed as to annexation at Washington.—July 25.

Harbors, U.S., Captain Malin recommends appropriations for Buffa harbor, Tonawanda harbor, Niagara river, Wilson harbor and Alcott harbor.—July 17.

HAYTI.—Douglas Frederick, appointed to be minister resident and Consul General of United States to.—July 1.

Great Britain notifies Hayti not to molest British ships visiting insurgent ports.—July 12.

Legitimate arming young women to fight, letter from Port au Prince dated June 29 arrives at New York.—July 11.

Lieut. Thurston concludes his enquiry into charges made by Germany, that assistance was given Matafia by British Consul at Ajla.—July 6.

Port-au-Prince, Hippolyte assaults outer works, city in a state bordering on frenzy, letter to New York *Times*.—July 7, reported July 19.

Port-au-Prince Hippolyte hurled back into interior from outworks, and again advances on city. Arcabai strongest fortress captured.—July 10.

Port-au-Prince, Hippolyte endeavors to take Fort La Coupe, and is defeated by Legitime.—July 18.

Hippolyte attempts to take Port-au-Prince on 11th July, and is repulsed, news brought to New York by Atlas line steamer "Alene".—July 22.

Admiral Gberardi reports from Port-au-Prince.—June 10, reported July 23.

Battle east of Port-au-Prince, on 17th Inst., Hippolyte driven from his position. Steamer "Prince Frederick," from Port-au-Prince, arrives at New York with news.—July 28.

High School Masters of Ontario, convention at Toronto.—July 31.

Hocking Canal, Sharpe's Dam at Sugar Grove near Lancaster, Ohio, bursts, doing much damage.—July 20.

Hops, London, Eng., pocket of this season's sold.—July 23.

Horses trotting, Louisville, Ky., L. L. Dorsey's stock of, sold.—July 29.

Horse thieves, Albuquerque, N.H., Deputy Sheriff Lawson organizes posse, and gives chase to band of horse thieves, battle takes place and leader of thieves shot dead, and Deputy Sheriff receives serious wound.—July 20.

Hudson Bay Company, London, meeting at, several objections to report presented.—July 9.

Hungary, Transylvania and Bukovina, cyclone sweeps over, hundreds of persons killed, several districts completely ravaged.—July 28.

Illinois Steam Company purchases large tract of land adjoining its South Chicago rolling mills, and will erect a plant in which will be employed 2,000 additional men.—July 30.

Imperial Federation League, Tupper Sir Charles, elected a member of Executive Council.—July 31.

Imperial Federation, Sir Charles Tupper's scheme, Hon. M. Bowell, Minister of Customs, and Hon. John Carling, Minister of Agriculture, discuss same at Ottawa.—July 4.

Imperial Federation, Salisbury Lord, speaks on, at Mile End, London.—July 16.

IMPERIAL PARLIAMENT.—Commons and Lords, Delagoa Bay railway concession, statements by Sir James Fergusson and Lord Salisbury.—July 1.

Commons, debate on suppression of Nationalist meeting at Cork.—July 1.

Commons, Prince Albert Victor, Queen's message respecting allowance, to read.—July 2.

Commons, Samon, Sir James Fergusson denies England has agreed to retire from her position as one of three protecting powers.—July 2.

Commons, provision for Prince Albert Victor and Princess Victoria of Prussia referred to select committee.—July 4.

## IMPERIAL PARLIAMENT.—Continued.

Commons, Royal grants, committee of 23 members appointed.—July 9

Commons, title "Honorable" Under-Secretary for colonies says, no new regulation issued with regard to.—July 9

Commons, Egyptian frontier, Mr. Stanhope, Secretary of State for war, states government taking measures to protect.—April 10

Commons, motion giving the Government remaining time of Parliament accepted.—July 11

Commons, Scotch local government bill, Mr. Howorth's motion to omit free education clause defeated.—July 11

Commons, Egypt, Mr. Stanhope gives official estimate of the number of the invaders of Egypt under Nadei Imin.—July 11

Commons, Scotch local government bill passes committee stage.—July 16

Commons, Egypt, Hon. Edward Stanhope read communication from Gen. Grenfell containing reply of Nadei-Jumi to General's demand for surrender.—July 18

Commons, committee on royal grants, Rt. Hon. W. H. Smith intimates to committee that government not inclined to agree to proposal that no grants shall be made to grand-children of the Queen outside the direct line of succession to the throne.—July 19

Commons, Italy and France, attitude of British in case of war between, Mr. Labouchere questions government thereon.—July 19

Commons, Western Australian bill withdrawn by Government.—July 22

Commons, Maritime conference, Sir James Ferguson states no final programme for, yet been agreed upon with American government.—July 22

Commons, First Lord of Admiralty speaks as to the construction of war ships during the present reign.—July 22

Commons, report of committee on Royal Grants laid on the table.—July 22

Commons, railways in Ireland, £600,000 granted for construction of.—July 23

Commons, Royal grants, report of Parliamentary committee on, debated, Mr. Labouchere proposes his amendment.—July 25

Commons, Royal grants, Mr. Labouchere's motions to adopt his substitute for the Royal grants committee rejected.—July 25

Commons, Royal grants bill, Mr. Morley's amendment defeated.—July 29

Commons, Royal grants bill passes its first reading without a division.—July 29

Commons, Royal grants bill passes its second reading.—July 31

Commons, Ontario boundary bill read a second time.—July 31

Commons, Ontario Boundary Bill read third time.—July 31

Lords, Australia Western, bill granting House rule, constitution in, passed.—July 11

Lords, Ontario Boundary Bill passes all its stages.—July 20

Royal grants, British Government accepts proposal by John Morley for increased allowance to Prince of Wales, enabling him to provide marriage portions for his children, be substituted for proposed special grants.—July 18

India, Indus river overflowed, 40 persons drowned at Lankhana, despatches received.—July 9

Indianapolis, Ind., Salvation Army barracks, attempt to blow up with powder.—July 9

India affairs, U. S. Senate committee on, arrives at Juneau, Alaska.—July 21

Indians, Colville agency, Stevens County, Washington Territory, Indians burn eight square miles of hay laid in, and threaten lives of settlers, telegram received by Commissioner of Indian affairs, Washington.—July 27

Indians on Devil's Lake reservation, Northern Dakota, refuse to accept lands in severalty as contemplated in general allotment Act of 1887.—July 20

Indians, Red Lake, Chippewa, commission successful, and Indians cede the greater portion of their reservation.—July 10

Insanity, Cedar Creek, W. T., Roland Johnson, religious maniac, kills his wife and children, and shoots himself.—July 15

Insanity, Elizabeth, N. J., epidemic of.—July 2

Insurance Companies, Chicago, State Attorney sues to recover penalties for not taking out licenses, Judge Clifford declines to grant rule to compel companies to produce their books.—July 24

International Exposition, New York, Mayor Grant invites five hundred prominent men to consider the advisability of holding exhibition in 1892.—July 17

International Labor Congress postponed by Swiss Bundesrath until the Spring.—July 16

International Labor Congress, Paris, pass series of resolutions demanding a universal maximum of eight hours for a day's labor, one holiday a week, and non-employment of children under 14 years of age.—July 18

International labor congress, close of session.—July 22

International Congress, Washington, Brazilian government appoints commission to.—July 20

International Socialist Congress opened at Paris.—July 15

International Working People's Association at New York celebrates party day.—June 14

Interstate commerce, United States, Senate commission on setting at Boston.—July 6

Interstate commerce, committee on, Boston, ex-Gov. Smith, of Vermont, explains Central Vermont system.—July 8

Interstate Commerce Committee of U.S. Senate, Chicago, report of special committee of Board of Trade on questions submitted by Senate committee read.—July 15

Interstate Commerce railway association, Chicago, discussion of disputes between Southern Pacific and Canadian Pacific on the subject of differentials.—July 29

IRELAND, Cork, suppression of Nationalist meeting debate in British House of Commons.—July 1

Clanciarde estate, Galway, further evictions, battering rams used.—July 9

Cloak-and-suit Court, W. O'Brien, M.P., and James Gilhooly, M.P., summoned to appear.—July 18

Cox J. R., M. P. for East Clare, summoned before Drogheda Court, to answer charge of conspiracy.—July 2

Churchill Lord Randolph, speaks at Birmingham, and recommends as final solution of Irish question an Imperial loan of £100,000,000 to enable tenants to buy their holdings.—July 30

Dublin, Kennedy Mr., formerly M.P. for Cavan, elected to succeed Mr. Sexton as Lord Mayor of Dublin.—July 22

Dublin, Magistrate Fitzgerald obtains damages from *Freeman's Journal* and *Leinster Leader* for libel in calling him an "invincible."—July 24

Drogheda, case against Messrs. Fox and Gill, M.P.'s, for conspiracy dismissed.—July 9

Dublin, Michael Davitt presides at meeting of the George Club, and speaks on new Irish League.—July 13

Dublin, Timothy Healy, M.P., presides at meeting of National League in Dublin, and speaks on withdrawal of Parnell and his colleagues from commission.—July 16

Dublin, Winstanley Avo James, a Protestant, and Parnellite, unanimously nominated to be Lord Mayor for 1890.—July 1

Father Covey of Dunmanway, London *Standard* consents to apologize and pay £100 for stating he publicly appealed to God to strengthen the hand of the man who killed Inspector Martin at Gwedore.—July 24

Gill T. P. and Cox J. R., Nationalist members of Parliament, arrested in London and taken to Drogheda.—July 7

Lane William John, M. P. for East Cork, arrested for inciting Tenants to adopt plan of campaign.—July 2

Lifford, Court dismisses appeal of Charles Conybeare, M. P., for offences under Crimes Act.—July 4

Limerick, Matthew Harris against *Irish Times* for libel gets verdict of £1,000.—July 11

Tenants Defence League, Parnellite members of Parliament meet in room of House of Commons and appoint committee to prepare constitution.—July 15

New Tenants' defence league formally constituted at meeting of Irish Parliamentary party at London, Eng.—July 21

Railway construction, British House of Commons grants £260,000 for.—July 23

Tenants' defence league, Parnellite members of Parliament meet in London to discuss same, election of Treasurers.—July 22

Tipperary, Dr. Tanner, M.P., sentenced for assaulting police inspector Stevens in May last.—July 29

Tipperary, O'Brien Mr. W., M.P., arrives at, and announces the formation of Tenants' Defence League.—July 11

Trustees of National Library and Board of Visitors of Dublin Museum of Science adopt resolutions urging Queen to visit Ireland.—July 23

Irish National League, New York, meeting of Municipal Council, John Devoy attacks Michael Davitt.—July 16

Rome, negotiations in progress between the Pope and the Italian Premier Crispi looking to a reconciliation between the Vatican and the General.—July 15

Iron Mills, Philadelphia rolling mill Association and Amalgamated Association agree on wage schedule.—July 1

ITALY.—Cuni, French lieutenant arrested by authorities for sketching forts of the line.—July 29

Legislative elections, Ministers hold council in Rome, and decide to post one them in view of the present straitened situation in Europe.—July 22

Japan, Chan Ping and Ping Yueng districts flooded by bursting of water spout, upwards of 6,000 lives lost.—2nd June, rep. July 16.

Japan, town of Kumamoto Island of Kion Sion destroyed by earthquake.—July 29.

Jews in Persia, Baron Rothschild heads deputation to Shah in London about their condition.—July 4.

Johnstown, flood at, many families flooded out.—July 2

Johnstown flood, coroner's enquiry into death of Ellen Hite, owners of Dam held responsible.—July 6.

Johnstown, N.Y., cloud burst at, fifty persons drowned.—July 9.

Jones Mr. W. C., editor of Paris, Ont., *Star Transc-ipt*, death of.—July 6.

Journymen Plumbers and Gas and Steamfitters Laborers' Union of New York decide to withdraw from Knights of Labor.—July 31.

Jung Sir Salar, Mahant of Hyderabad, death of.—July 7.

Kennel Club, London, rules its dogs ears out, dogs not eligible for show.—July 11.

Knights of Labor, Chicago, meeting of the Executive board.—July 16.

Knights of Labor, Chicago, circular issued bearing signatures of principal officers with the object of forming an alliance.—July 17.

Knights of Labor, Australia, charter granted by executive committee in Chicago to the first district assembly of the order organized in Australia.—July 22.

Knights of labor, Birmingham, Ala., Trades Council eliminates knights from the organization.—July 28.

Knights of labor, Chicago, Mr. Powderly's explanation of the board's management of the order unanimously approved by meeting.—July 21.

Knights of Labor, Chicago, executive board decides to issue a call for money to aid striking miners of Bruidwood, Ill. district.—July 22.

Knights of Labor, Chicago, board finishes its session.—July 24.

Knights of Labor, Journeymen Plumbers and Gas and Steamfitters Laborers' Union of New York decide to withdraw from.—July 31.

Labor conference has an exciting discussion on a Belgian proposal to unite with the Marxist congress.—July 16.

Labor Congress, Paris, Allemaire Mr., French delegate, jointly elected to presidency.—July 18.

Labor Congress, Paris, close of session.—July 22.

Labor Congress, Paris, resolutions passed calling upon Governments to oppose trusts.—July 22.

Labor importation, United States, solicitor to Treasury decides that members of a band are not artists and cannot be legally imported under contract.—July 8.

Land laws, Churchill Lord Randolph, speaks on reform of, at Walsall.—July 30.

Lead Trust, New York, heavy decline in certificates.—July 12.

Leather workers convention, Philadelphia, adjourned *sine die*.—July 22.

LEGAL, Baltimore, Canada Shipping Co., action against by Louis Meyer for \$40,000 for loss of cattle decided in favor of defendants.—July 6.

Chicago, Horton Judge, decides the law requires a written complaint in every case of arrest by the police.—July 8.

Chicago, Divorce, Carter divorce case, new trial refused.—July 15.

Chicago, Bell Telephone Company against Cushman Telephone Company, final decree rendered by Judge Blodgett in Federal Court.—July 24.

Chicago, Insurance companies state attorney sues to recover penalties for not taking out licenses, Judge Clifford declines to grant rule to compel companies to produce their books.—July 24.

Divorce, Chicago, Mary Gottschalk, resident of Pennsylvania, obtains divorce from her husband.—July 24.

Divorce, San Francisco, Cal., Supreme Court of California, new trial in Sharon divorce case refused.—July 17.

Ireland, Dublin, Magistrate Fitzgerald obtains damages from *Freeman's Journal* and *Leinster Leader*, for libel in slandering him as "invincible".—July 24.

Ireland, Limerick, Matthew Harris against *Irish Times* for libel gets verdict of £1,000.—July 11.

Little Rock, Ark., suit filed by Jay Gould in U. S. court, to recover \$425,000 from Little Rock, Missouri River and Texas Railroad.—July 24.

London, Eng., Privy Council, case of town of St. Johns, P. Q., and Central Vermont Railway as to the right of the municipality to tax railway bridges argued.—July 12.

London, Eng., O'Brien William, M.P., against Lord Salisbury, action for libel, trial of, begins.—July 19.

London, O'Brien W., M.P., against Lord Salisbury for slander, verdict for defendant.—July 29.

London, O'Brien W., M.P., against Lord Salisbury for libel; O'Brien applies for a new trial.—July 31.

New York, Ives Henry O., and Stayner George H., proceedings to secure release of, by a writ of *habeas corpus* from prison where held on an order for arrest in a civil suit for \$2,500,000 brought by Cincinnati, Hamilton and Dayton Railroad Company.—July 31.

## LEGAL.—Continued.

Ottawa, Lynch Hon. W. W., appointed to Superior Court Bench for Province of Quebec.—July 7.

St. John, N. B., Supreme Court adjourns further hearing of case against Mr. Ellis, M. P., for contempt, to consider points raised by his counsel.—July 5.

San Francisco, Probate Court, Blythe Thomas H., the late, trial concerning property of, commences.—July 15.

Trenton, N.J., vice-chancellor Van Fleet holds that a woman's marriage to her step-grandson is valid.—July 26.

Lethbridge, Sir Roper, M. P., resigns his seat in British House of Commons, for North Kensington.—July 4.

Lightning, Johnson's Station, Pa., an iron tank, containing 26,000 gallons of oil struck and ignites the oil which flows into the creek.—July 2.

Lumber, meeting of lumber merchants at St. John, N. B., protests against policy of New Brunswick government.—July 25.

Lunatics, Minneapolis State Asylum, at Rochester, official investigation brings out shameful tales of brutality.—July 1.

Lundy's Lane, battle of, The Lundy's Lane Historical Society keep 75th anniversary of battle of.—July 25.

Lutheran Synod, Canada district of, concluded at Ottawa.—July 31.

Lynching, Cheyenne, Wyo., Kate Maxwell noted "Battle Queen" and James Averille, postmaster at Sweetwater in Wyoming, lynched by cowboys for enthralling.—July 22.

Lynching, Kelly, N. B., two Mexican cattle and horse thieves hanged by party of cow boys.—July 22.

Lynching, Lafayette, La., Felix Bey, negro who had brained his wife, lynched, warrants issued to arrest twenty-six persons implicated.—July 30.

Mails, Canadian Atlantic mail service undertaken by Messrs. Anderson of London, signed at Ottawa.—July 16.

MARRIAGES, Chicago, Foster Hon. Geo. E., Canadian Minister of Finance, to Mrs. Addie C. Chisholm, well-known temperance worker and lecturer.—July 3.

Chicago, Emmons Elaine, engaged to Anita McCormick, second daughter of the late G. H. McCormick, of Reaper fame.—July 15.

Bryce Prof. James, M.P., south division Aberdeen, to Elizabeth Ashton, daughter of ex-Sheriff Ashton of Lancashire.—July 23.

Fitzmaurice Lord Edmund, engaged to be married to Miss Fitzgerald, well-known Oriental scholar.—July 8.

London, Eng., Deillo Lord, eldest son of Earl of Clancarty, to Bella Belton, notorious variety artist.—July 12.

London, Eng., Puleston Sir John, daughter of, to Ashurst Morris, at Chapel Royal Whitehall.—July 2.

London, Eng., H. R. H. Princess Louise of Wales to the Earl of Fife.—July 27.

Regina, Bourrinct Dr., clerk of the House of Commons, married to Miss Cameron of Regina.—July 2.

Trenton, N.J., Vice-Chancellor Van Fleet holds that a woman's marriage to her step-grandson is valid.—July 26.

Mason Dr. C. C., grand commander of Knights Templar of California, death of.—July 15.

Masomc, Marion, Ia., injunction issued against Grand Lodge of Iowa, restraining them from putting into effect legislation referring to German bodies.—July 29.

Masonic, Owen Sound, Ont., meeting of Grand Lodge.—July 16.

Masonic, Washington, German Scottish rite, Harrison Dignan, M. W. G. M., of masters of district of Columbia, issues edict warning all members to withdraw from German body.—July 27.

Massowah, Italian Government orders that a battalion leave Massowah and occupy Asmara.—July 30.

MEDICAL, Munster, Westphalia, Drs. Fricke and Boemerhane fatally injured by bursting of ether report in Dr. Koenig's laboratory.—July 4.

New York, Dr. John McMerney, mysterious disappearance of.—July 4.

South Carolina Medical Society, Dr. McDow, slayer of Captain Dawson at Charleston, S.C., expelled.—July 18.

Washington, Hammond Dr. W. A., interviewed as to result of his elixir of youth.—June 31.

Zanzibar, Dr. Schuelekopf, surgeon-in-chief of Capt. Wissman's expedition, drowned.—July 27.

Metakahla, William Duncan arrives at Victoria, B. C., from Alaska, and reports as to the condition of Metakahla.—July 17.

Mexico, city of Juarez, ex-President, anniversary of death celebrated by Liberals by grand procession to the cemetery.—July 18.

Mexico, Sassy Souvra, Custom House collapses and three men killed.—July 22.

MILITARY, Canadian, St. Johns, P. Q., 5th district military camp at, inspection by Sir Fred Middleton.—July 3.

British, Egypt, three battalions of British infantry and squadron of Hussars ordered from Cairo to Assouan.—July 8.

## MILITARY.—Continued.

Britain, Aghershot manouvres suspended by orders from War office, and two of regiments taking part ordered to hold themselves in readiness for active service in Egypt.—July 11.

Britain, nine hundred and fifty members of Connaught rangers sent to Malta to replace troops sent to Egypt.—June 12.

British troops, 800 start for Assouan.—July 20.

Bulgaria, at Demirchik, near Adrianople, Russian agents collecting soldiers who desert from Bulgarian army.—July 20.

Dominion Rifle Association executive of, meet at Ottawa to arrange for coming meeting.—July 30.

France, Minister of War orders Col. Vincent to be placed under arrest for publishing evidence given in Senate Court in Gen. Boulanger's case.—July 16.

France, army bill compelling Seminars to undergo years military service, Chamber of Deputies agrees to Senate's amendments to bill.—July 8.

France, review of troops held by Pres. Carnot at Longchamps, Paris.—July 14.

Germany, army contractors at Berlin, named Hagemann and Wallack sentenced for bribing paymasters.—July 3.

Germany, French exhibition, forbidden by Emperor to visit.—July 9.

German, Zanzibar, Countess Blucher opened second military hospital for treatment of German soldiers.—July 11.

German, official report of operations in Western Africa published.—July 22.

Germany, Von Schellendorf General, in speech at Koenigsberg, said all fears of war groundless.—July 24.

Germany, Government decides to ask for extra credit for the army to be devoted exclusively to artillery branch of the service.—July 30.

Italy, Government orders that a battalion leave Mazowah and occupy Asmara.—July 30.

Italy, French lieutenant arrested by authorities for sketching forts of the harbor of Coui.—July 23.

Massachusetts rifle team begins series of contests with English crack shots at Mundhead, and defeats Honorable Artillery team.—July 1.

Massachusetts Rifle team contests with Royal Berkshire Volunteer's team on Lord Wantage's Chirn range.—July 2.

Massachusetts rifle team, and London Rifle brigade, match between, at Rainham, Eng.—July 3.

Massachusetts rifle team shoots against Sussex team at Brighton, Eng.—July 4.

Russia, Turkish frontier, despatch from Erzromm says 80,000 men concentrated.—July 23.

Serbia, Military Council decides to arm 30,000 men of the third levy.—July 13.

Serbia, government preparing to arm second reserves.—July 16.

Turkey, government resolves to send to Crete eight battalions of troops.—July 30.

Turkey prepares to send several battalions to Crete, in consequence of threatened rising of the people.—July 20.

United States, Pie General W. A., death of, at Monrovia, Ala.—July 7.

Wimbledon, London, corporation and other prizes shot for.—July 15.

Wimbledon, National challenge trophy won by English rifle team.—July 15.

Wimbledon meeting, Queen's prize won by Private Reid of First Lankashire regiment.—July 16.

Wimbledon, Kolapore cup won by Canadian team.—July 17.

Wimbledon meeting, Elcho challenge shield won by Irish team.—July 15.

Wimbledon meeting, Stewart contest won by Corporal W. D. Huddleston of Massachusetts team.—July 18.

Milling Syndicate, Seamus S. H., Treasurer of National Millers' Association, interviewed thereon at Milwaukee, Wis.—July 18.

Mills, Minneapolis, Van Denzen Line of elevators purchased by English Syndicate.—July 19.

Mills, Minneapolis, English Syndicate combines to purchase several of the largest mills.—July 17.

Millers, Dominion Millers Association, Toronto, annual convention opens.—July 9.

Millers, Braaford, Ont., millers at Oxford, Norfolk, Brant, Haldimand and Waterloo meet and form an association.—July 25.

Mingrebia, Prince Nicolas of, formerly candidate for Bulgarian throne, death of, in the Caucasus.—July 9.

Miners, Conk, Altoona, Pa., 40 miners representing 14,000 meet and decide not to enter into general suspension but call out all working under district prices.—July 8.

Miners, Dortmund, Germany, police disperse meeting of, and arrest Herr Diekmann, member of Socialist Congress at Paris.—July 29.

Miners, Sagor near Gratz in Styria, men demand increase in pay of 20 per cent., mine owners offer ten per cent.; German named Trefoil arrested for haranguing the men, whereupon riot ensues.—July 26.

Miners, Spring Valley, Ill., Coal Co., 150 men employees occupying tenement houses served with 15 days notice to quit.—July 22.

Miners, Spring Valley, Ill., the lacked out miners starving, relief brought to them from Chicago.—July 26.

Mines, Lake of the Woods, fifty thousand dollars offered and refused for one of them.—July 16.

Mining, Avon, Eng., purchased by Wright, Butler & Co., of Manchester.—July 11.

Mining, Germany, owners forming insurance company to insure themselves against loss through strikes and explosions.—July 4.

Ministerial banquet, Mansion House, London, Eng.—July 31.

Minneapolis State lunatic asylum, official investigation brings out shameful tales of brutality.—July 1.

Mormons, Boise City, Idaho, the Constituted Convention unanimously passes article on education and suffrage.—July 26.

Mormons, Wilson County, Tenn., two hundred people band together to drive Mormon elders and converts from the county.—July 27.

Morse Mrs. Johanna S., connected with the Beecher-Tilton scandal, dies at New York.—July 27.

MURDERS, attempted, Niagara, Colenan woman has her throat cut and left breast stabbed by Douglass Cook.—July 1.

Africa East, Neilson, officer of East Africa Company, murdered by Chief Bushiri, Wessan Capt., offers reward for his arrest.—July 27.

Bastrop, Texas, Cedar Creek, colored, Judge Orange Wickes shoots Alf. Litten in court, and precipitates fearful conflict.—Reported July 22.

Bad River Station, Wis., Fuchs Joseph, murders his 18 year old bride.—July 18.

Firingham, Ala., Duncan Rev. Henry, who poisoned his wife and eloped with Miss Boldser, captured at Dalton.—July 1.

Boston, White Dr. William H., medical electrician, shoots his wife and commits suicide.—July 13.

Bright, Ont., Mennonite Church near, child cremated by person unknown.—July 17.

Buffalo, N.Y., McNulty Henry Barney, an armless man, murdered by Patrick Doyle, a one-armed man.—July 8.

Calgary, Man., Fisk William, charged with murdering an Indian woman found guilty of manslaughter.—July 14.

Carthage, N.Y., Fred. Farr, engineer on the Carthage and Idorondack Railway, shoots and kills his wife and commits suicide.—July 31.

Cedar Creek, W.T., Johnson Roland, kills his wife and children, and shoots himself.—July 15.

Charleston, Dawson Col., acquittal of Dr. McDow.—July 1.

Chicago, Cronin, Burke extradition case resumed at Winnipeg.—July 3.

Chicago, Cronin, application made through Sir Julian Paucelote, British Ambassador at Washington, to Dept. of Justice, Ottawa, for extradition of Martin Burke.—July 4.

Chicago, Cronin Dr., Burke extradition case at Winnipeg, further hearing and adjournment.—July 6.

Chicago, Cronin Dr., letter found at Niagara Falls, purporting to be written by person who has assisted in the killing and had committed suicide.—July 6.

Chicago, Cronin, Niagara Falls, letter discovered at.—July 7.

Chicago, Cronin, man arrested at Albert Lea mine supposed to be Cooney.—July 8.

Chicago, Cronin Dr., Burke case called on, and adjourned until tomorrow peremptorily.—July 8.

Chicago, Cronin Dr., special secret meeting of the executive committee of the Citizens' Association held, and decide to raise fund to prosecute the murderers.—July 9.

Chicago, Cronin Dr., Burke extradition at Winnipeg, Charles J. Carison identifies Burke.—July 9.

Chicago, Cronin Dr., Burke's extradition ordered at Winnipeg.—July 10.

Chicago, Cronin, Judge Horton refuses to issue writ of *habeas corpus* for release on bail of John F. Beggs, chief officer of camp 20, Clair du Guel.—July 12.

Chicago, Cronin, San Francisco, Cal., Maurice Walsh arrested.—July 14.

Chicago, Cronin, Judge Horton refuses senior Guardian Beggs's application for writ of *habeas corpus*.—July 16.

Chicago, Cronin, another application for release of John F. Beggs on bail refused.—July 17.

Chicago, Cronin, Burke extradition matter, papers received at Department of Justice, Ottawa, from Winnipeg.—July 17.

Chicago, Cronin, application at Winnipeg by Martin Burke's counsel, for writ of *certiorari* granted.—July 23.

Chicago, Cronin, suspects arraigned before Judge Horton, all the prisoners except Conglitz say they are ready for trial.—July 25.

Chicago, Cronin, Burke case at Winnipeg, the full court asked that a rule releasing Burke be made absolute.—July 25.



## MURDERS.—Continued.

Chicago, Cronin, Dwyer William, street car driver, mentioned in connection with, located at Kelly's Hotel, West Toronto Junction.—July 20.

Chicago, Cronin, the five suspects arraigned, and all plead not guilty; O'Sullivan's attorney makes motion for change of venue.—July 20.

Chicago, Cronin, Martin Burke's appeal from order of commitment made by Judge Bain dismissed by full court.—July 30.

Chicago, Cronin, warrant for extradition of Burke signed at Ottawa.—July 31.

Copenhagen, Elvira Madigan, circus performer, on Island of Lanesing, killed by Count Sparre her lover, who shoots himself.—July 23.

Courville City, Oregon, Eatenhover Mrs., and child murdered on farm of John Gilman, husband arrested.—July 11.

Detroit, Mich, Morris Crawford Hostler, killed by an unknown man from a buggy at the corner of Beaubien and Mueomb streets.—July 23.

Detroit, Mich., Wolbeck William, in general row in saloon, kicked to death, two men John Cook and Thomas Forsyth arrested.—July 27.

Edgerton, Ohio, Heady Hiram murders his wife, and Mr. Newman, farmer, his father-in-law, and then shoots himself.—July 21.

Elk Township, Clayton County, Ia., Wesley Ellis, 11 years old, murders his father and step-mother.—July 24.

Geneva, N.Y., Eleanor O'Shea, murderer John Kelly, hanged at Canandaigua.—July 10.

Edgefield County, S.C., Fleming Rev. E. F. alias John Yeldale, pastor of Arthur Street church (colored), Pittsburg, Pa., arrested for murder in 1886.—July 9.

Lafayette, La., Felix Keys, who murdered his wife, taken from goal and lynched.—July 11.

Lexington, Oklahoma, City Marshal Henry Simons shot dead during an altercation by Francis L. Jones.—July 30.

Liberty County, negro child killed by its parents as a sacrifice.—Reported July 24.

Little Falls, Minn., Frank Eich, the murderer Albert Bullock hanged.—July 19.

Liverpool, Maybrick James, true bill returned against Mrs. Florence Elizabeth Maybrick.—July 27.

Liverpool, Maybrick Mrs. Florence, arraigned for trial for murder of her husband.—July 31.

London, Castle Alley, Whitechapel woman supposed to be another victim of Jack the Ripper.—July 16.

London, Eng., attempted murder and mutilation of a woman near London Bridge, and man supposed to be "Jack the Ripper" captured.—July 20.

Louisville, Ky., Dilger and Stuart, two murderers, executed, horrible scene at the execution.—July 31.

Murray Canal near Brighton, Ont., Breeze George, poisoned by his wife on May 7th, Coroner's jury bring in verdict of wilful murder on evidence of Breeze's daughter.—July 18.

New York, Charles Giblin and Ferdinand Carolin sentenced to be hanged.—July 23.

Oklahoma, Dalton Robert, Deputy United States marshal, shot dead by baseball match.—July 14.

Owensboro, Kan., Frank Morris fatally stabbed by Ben. Bates at a baseball match.—July 21.

Oxford, N.J., Bollinshire Michael, his murderer Michael Bolak hanged at Belvidere, N.J.—July 16.

Quitman, Miss., Taylor John, execution of negroes Prince Fleming and Richard Jordan, murderers.—July 3.

Mount Pleasant, Fla., Frances Cooper, colored, poisons three negro women who dine with her, and one dies.—July 9.

Palouse City, W. T., Johnson R. D., kills his wife, 14 year old son, 7 year old daughter, and commits suicide.—July 6.

Pittsburg, Pa., Moseley Mrs. Elmina, shot by Richard Lewis, her boarder, who also shoots Emilie Myers her sister.—July 9.

Pittsboro, Pa., Creahan poisoning case, coroner's inquest, Edward Glynn and wife charged with causing death of latter's mother for the purpose of securing insurance money.—July 11.

St. John's, Newfoundland, Silas Archibald, merchant, his partner William Parrish hanged for his murder.—Reported July 22.

St. Louis, Mo., Davis Lillie, inmate of a brothel, shot by Daly James T., gambler, who shoots himself.—July 19.

San Francisco, mongolian shot by fellow highlander.—July 13.

San Francisco, Yung, Chinese sewing machine operator, fatally shot in back by Ah Huen.—July 15.

Shelbyville, Ind., Garvin Mrs. Mollie, attacked and killed at her home by Charles Suttles.—July 9.

Somerville, Mass., Smith Mrs. Catherine, and her son Thomas, shot dead by Augustus Rosenberg.—June 13.

Star City, Ark., Hunter Joseph, a planter, four children of, poisoned by arsenic being placed in their food.—July 16.

## MURDERS.—Continued.

Taney county, Missouri, hundreds of men in arms, in search of Miles boys Billy and Manuel.—July 8.

Toronto, Smith James, killed by Hugh McKay.—July 8.

Toronto, Hector McDonald murdered in Insane Asylum, by Barker Porter, a lunatic.—July 17.

Wallace, N.M., Moore Deputy Sheriff, shot dead by Joseph Chaeba, a small-pox attendant ordered to quit the town.—July 26.

Wauwas, Ind., Danks Mrs. Martha, arrested for murdering her fifteen months old child, and her husband Daniel Danks arrested for being accessory.—July 20.

Whitechapel, inquest.—July 18.

Whitechapel, Castle Alley, Englishman arrested for.—July 19.

Whitechapel, William Brodie suspected "Jack the Ripper" arraigned before police magistrate and remanded.—July 20.

Whitechapel, William Brodie, who confessed while intoxicated to being the murderer, discharged from custody.—July 27.

Whiting Station, Lake County, bodies of three unknown men, one colored and two white, found, each with fatal wound on the back of the head.—July 24.

Music, Ottawa, arrangements completed for establishment of college of music in addition with the London, England, College of Music.—July 22.

Nails, Central Nail Company of Wheeling, West Va., chartered.—July 29.

National Confectioners Association meets at Chicago, and offers a reward for conviction of adulteration.—July 2.

National Educational Association, Nashville, Tenn., session of.—July 18.

NAVAL, France, Krantz, Admiral, Minister of Marine and Colonies, demands from French Chamber of deputies extra credit of 60,000,000 francs for navy.—July 6.

British, Crete, three British men-of-war ordered to.—July 13.

British Government accepts tenders for construction of 17 vessels on The Clyde, Lorne and Mersey.—July 18.

British, armored cruiser "Aurora" shifts her plates in a heavy sea, and ships so much water that she becomes helpless.—July 25.

British warship "Sultan" raised at Malta.—July 26.

France, Chamber of deputies, Admiral Krantz, Minister of Marine, declares the need of several new warships.—July 9.

France, Chamber of Deputies approves bill providing for credit of 50,000,000 francs for building warships.—July 15.

France, two French men-of-war ordered to proceed to Crete.—July 30.

Germany, number of naval officers at Berlin and Keat arrested, charged with wholesale bribery.—July 21.

German, Tanga, German warships shell the town and land their men.—July 10.

Russia, cruiser ordered to Crete.—July 12.

P. S. gambler "Petrol" makes successful trial trip.—July 1.

Washington, Court Martial that tried commander Harrington, on the charge of grounding the practice ship "Constellation" near Cape Henry light on June 18, finds him guilty and fixes sentence at two years suspension.—July 27.

Newfoundland, Brig harbor, trouble between English and French, detachment of men from warship "Emerald" stationed ashore to maintain peace.—July 6.

Newfoundland annexation, Rev. Doctor Howley, Apostolic Prefect of Newfoundland, interviewed in London by Pall Mall Gazette.—July 12.

Newport, Ky., four men claim to be mayor.—July 16.

New South Wales, Legislative Assembly passes bill providing for payment of its members.—July 31.

Nicaragua, despatch from Panama says Costa Rican troops marching on Nicaragua in consequence of Costa Rica canal trouble.—July 4.

Nicaragua Canal, Señor Zebdon, Minister from Costa Rica to United States, arrives at Washington and denies report of trouble between Costa Rica and Nicaragua.—July 9.

Nihilism, Berlin, Police deliver up student suspected of being a Nihilist to Russian authorities.—July 19.

Norquay Hon. Mr., ex-premier of Manitoba, death of.—July 6.

Northern American Salt Company files articles of incorporation in Secretary of State's office, Albany, N. Y.—July 19.

Norway, Imperial yacht with Emperor William on board, arrives at Stavanger.—July 3.

Nova Scotia, Government loan, the \$300,000 four per cent. loan to run thirty years taken at from 14 to 13 per cent. premium.—July 17.

Oil springs, Crow's Nest Pass, 71 oil springs discovered at.—July 30.

oil, Vancouver, also covered in centre of city.—July 17.

Oklahoma, new crowd of settlers resolve themselves into opposition to city administration and issue call for new election, General Merritt commanding dept. of Missouri leaves for Oklahoma.—July 12.

Ontario, boundary bill passes all its stages in British House of Lords.—July 20.

Ontario Boundary Bill, read second and third time in British House of Commons.—July 31.

Panama Canal Co., French Senate committee approves bill for relief of.—July 6.  
 Panama Canal relief bill adopted by French senate.—July 11.  
 Panama Canal bondholder, the civil Tribunal at Paris decides the company cannot compel owners of lottery bonds to pay outstanding instalments.—July 27.  
 Paper mills, Lima, Ohio, purchased by American Straw Board Company.—July 27.  
 Paper manufacturers, English syndicate of, completes arrangements for combination.—July 19.  
 Paraguay, 20,000 acres of land in, purchased by Mr. Dickson, M.P. for St Stephen's Green, division of Dublin.—July 22.  
 Pardee Hon. T. B., late commissioner of Crown Lands for Ontario, dies at Sarnia, Ont.—July 21.  
 PARNELLTIMES, Commission, Davitt Michael, M.P., examined.—July 1. Commission, Mr. Byrne, M. P., gives evidence.—July 9. Commission, summons sent to Mr. Houston, secretary of Irish Loyal and Patriotic League, to produce books of League.—July 9. Commission, Messrs. Mayne, M. P., and John O'Connor, M. P., give evidence.—July 9. Commission, Davitt Michael, speaks in court on the placing of two bogus dynamite machines.—July 10. Commission, Mr. Soames and Mr. Houston, secretary of Patriotic League, give testimony and are called upon to produce books of the League.—July 12. Commission, court decides against application for the production of Patriotic League books.—July 12. Commission, Sir Charles Russell is instructed by Mr. Parnell to throw up his brief.—July 13. Commission, Matthew Harris, M.P. for East Galway, gives evidence.—July 16. Commission, Timothy Healy, M. P., presides at meeting of National League in Dublin, and speaks on withdrawal of Parnell and his colleagues from commission.—July 16. Commission, Mr. James O. Kelly, M. P., gives evidence.—June 16. Commission, Sir Charles Russell and his colleagues withdraw from the case.—July 16. Commission, Dr. Charles Tanner, M. P. for Midcock, gives evidence.—July 18. Commission, Parnell Mr., gives evidence and refuses to tell anything the trust funds.—July 23. Commission, Mr. Maloney, ex-official of Land League, Mr. Millar of the National Bank, and Mr. Tyrrell, cashier of the Bank, examined.—July 24. Parnellites hold meeting in London, and decide to demand a parliamentary committee to investigate the origin of the Pigott forgeries.—July 18. Parnell Mr. C. S., M. P., receives freedom from the city of Edinburgh.—July 20. Pasture, meeting at Mansion House, London, Prince of Wales supports: Pastureism.—July 1. Patents, Ottawa, Edison's Electricity Patents, Minister of Justice grants the application of Edison's solicitor for rehearing of decision of Mr. Pope cancelling patents.—July 23. Pelletier Edward E., barrister of St. Athanasus, Que., appointed revising officer for district of Ilerveille, P. Q.—July 19. Pennsylvania, Hyde Park, Pa., cave occurs in Hyde Park, explosion follows in which John Williams and Robert Roberts are killed.—July 24. Persia Shah of, London, arrival in.—July 1. Peru, Grace, British bondholders contract with Peru, first seven clauses approved by Peruvian chamber of Deputies.—July 18. Peruvia, anniversary of independence celebrated at Lima.—July 28. Petroleum, New York, flurry in the market.—July 22. Pic General W. A., death of, at Mourvins, Ala.—July 7. Pittsburg, Pa., riot among Italian laborers, one killed, another mortally wounded.—July 30. POPE, The gave a four hours' reception to Cardinals and Diplomats at Rome.—July 15. Keen Bishop, rector of Catholic University at Washington, interviewed at Nashville, Tenn., as to Pope's probable successor.—July 17. Negotiations in progress between the Pope and the Italian Premier Crispi looking to a reconciliation between the Vatican and the quinal.—July 15. Spanish Government forbids demonstrations calculated to enrage the Pope to come to Spain in the event of his leaving Rome.—July 20. Spain replies to a telegram from the Vatican that the Pope is granted an Asylum in Valencia.—July 3. Austria through Cardinal Gulimberti prevails upon the Pope to remain in Rome, *vide* Vienna correspondent of London Times.—July 12. Prince Bismarck, through Dr. Von Schlozer, the German representative at the Vatican, disabuses the Pope from leaving Rome, despatch to London Chronicle.—July 23.

Postal, Milwaukee, extensive thefts of registered letters reported.—July 20. Press Association, Canadian, annual meeting at Toronto.—July 18. Prince Edward Island, Senator Carvell appointed as Lieut-Governor to succeed Lieut-Governor Macdonald.—July 12. Princeton, Butler county, Ohio, village nearly demolished by storm.—July 14. Proctor Professor R. A., the late British Government gives widow pension of £100 a year.—July 12. Pugh Eliza Loftis Phillips, literature, wife of W. W. Pugh, Jan., dies at New Orleans.—July 26. Pythias Knights of, Grand Lodge of Chatham, Ont., election of officers.—July 3. Race conflict, Bastragh County, Texas, brought about at Cedar Creek by colored judge Orange Wickes, shooting and killing A. E. Letten, a white man, in Court.—Reported July 22. RAILWAYS, Baltimore and Ohio decide to make their tariff for corn and wheat on the basis of 20 cents from Chicago to New York.—July 3. Canadian Pacific Railroad offers to compromise the difference between itself and the Southern Pacific, rumoured in Chicago.—July 26. Central Vermont and St. Johns, P. Q., case as to the right of the municipality to the railway bridge, heard before Privy Council.—July 12. Chesapeake and Ohio Railway, Messrs. Drexel, Morgan & Co., of New York, become the owners of 100,000 shares of common stock.—July 22. Chicago, Transcontinental association, at meeting of, dispute between Southern Pacific and Canadian Pacific compromised.—July 31. Chicago and Alton fined \$200 by chairman Abbott of Western States Passenger Association for violating agreement reducing rate to \$26 from Chicago to Denver.—July 8. Chicago and Alton road, one of great trunk lines negotiating for purchase of.—July 18. Chicago, Interstate Railway Association meets with 28 roads represented, committee appointed to persuade Chicago and Alton and Denver, Fort Worth and Texas Roads to consider their withdrawal.—July 5. Chicago, presidents of lines in Interstate Commerce Railway Association meet and agree to advance rates from Peoria and St. Louis to St. Paul.—July 10. China, Emperor decides to issue edict for construction of Lung-Chow Railway, Marquis Tseng appointed general director of Chinese railways.—July 15. Columbus, Hooking Valley and Toledo railway announcement made that default on interest on 5 per cent. bonds due September 1st will be made.—July 20. Congo Railroad, two million dollars voted by Belgian Chamber of Deputies.—July 23. Congo, Belgian senate, sanctions credit asked by government for.—July 27. Delagoa railway, arrangements made to extend road to the frontier of Portuguese possessions in Africa.—July 20. Delagoa Bay railway concession, statement by Sir James Fergusson and Lord Salisbury in British Houses of Parliament.—July 1. Delagoa Bay, Portuguese government agrees to Lord Salisbury's proposition to submit the Delagoa Bay question to arbitration.—July 2. Delagoa bay, Portuguese directors resign.—July 2. Delagoa bay, Senator Gorney, Minister of foreign affairs, speaks on, at Lisbon.—July 4. Delaware, Lackawanna and Western gives notice, it will come into association with Trunk Line Association.—July 11. Denver and South Park road sold under foreclosure to representatives of old stockholders.—July 17. Emigrant pool, Baltimore and Ohio, Ontario and Western, and Delaware, Lackawanna and Western railroads join the pool.—July 17. Erie and Niagara Railway with Canadian Southern Railway Company, notice given that Union is an accomplished fact.—July 20. Fort Wayne to Chicago, new line to be constructed.—July 30. Great Northern Railway, P. Q., election of new Board of Directors.—July 22. Interstate Commerce Railway Association, Chicago and Alton railroad withdrawal of, presidents of other Kansas City lines authorized to take action to protect their interests.—July 11. Interstate Commerce Railway Association, committee confer at Chicago with Vice-President Harris of the Burlington and Northern in reference to North-Western situation.—July 11. Interstate Commerce, Railway Association, Chicago, discussion of dispute between Southern Pacific and Canadian Pacific on the subject of differentials.—July 29. Ireland, British House of Commons grants £600,000 for construction of.—July 23. Kingston and Pembroke, connection made at Harrowsmith, Ont., between it and Tanworth Railways.—July 26. Lake St. John, Maquick, P. Q., portion of Mr. Belanger's stone quarry gives way, and falls into river Bottom, carrying away three platform cars and ripping up railway line.—July 20.

## RAILWAYS.—Continued.

- Lake Shore and Nickel Plate roads give notice at Chicago that they will reduce rates on all grain and its products on the basis of 20 cents a hundred pounds Chicago to New York.—July 15.
- Leland, Stanford and C. P. Huntington decide to withdraw the Southern Pacific Railroad from Texas.—July 8.
- Little Rock, Missouri River and Texas Railroad, suit filed in U. S. Court at Little Rock, Ark., by Jay Gould, to recover \$425,000.—July 24.
- Manitoba and Northwestern Railway passes from owners to unknown purchasers.—July 24.
- Mattawa, J. O. Bailly, O. E., and party go north to Ilaburton to begin the survey of the new line projected by the Grand Trunk.—July 13.
- Midland route connecting Windsor with Queen's and Shelburne committees, meeting held at Shelburne, N. S., addressed by Premier Fielding and others.—July 24.
- Montmorency and Charlevoix Railway, first through train runs.—July 29.
- New Jersey Central, quarterly dividend of 1½ per cent. declared.—June 8.
- New York, joint committee of the Eastern and Western Trunk lines and representatives of New England railroads meet and agree upon a tariff.—July 11.
- New York, Lake Erie and Western announces reduction in rate of corn and wheat from Chicago.—July 10.
- New York Central Company make arrangements with Toronto, Buffalo and Hamilton Road for running powers from the Falls to Toronto.—July 23.
- New York, trunk line, passenger agents from an agreement for maintaining rail rates, in which they assured the steamship companies that they will give them as low a rate on immigrant business as they can obtain from outside sources.—July 31.
- Northern Colonization railroad, Montreal, election of officers.—July 4.
- Northern Pacific & Manitoba railway notify Manitoba Government that they have deposited \$300,000, being purchase money for Red-River Valley Road and Portage extension.—July 2.
- Northern Pacific and North West Central Railway, scheme to parallel Canadian Pacific line on foot, Oakes Mr. T. F., president of the Northern Pacific Road, interviewed by New York Times.—July 1.
- Northern Pacific, heavy land slide near Miles City, Mont., covers 500 feet of the track.—July 22.
- Pennsylvania railroad announces a reduction of 50 cents a ton in the rates of coal from the mines to Chicago.—July 16.
- Qu'Appelle, Long Lake and Saskatchewan railroad, Messrs. Morton, Rose & Co., of London, offering for subscription \$2,500,000 6 per cent. first mortgage bonds of.—July 30.
- "Soo" line decides to restore a portion of late cut in all rail west-bound freight rates.—July 2.
- Southern Pacific and Grand Trunk, Towns Mr. A. N., vice-president of Southern Pacific, publishes in pamphlet form his views on the subject of Canadian Pacific competition.—July 31.
- Trans-continental Association's session, Chicago, devoted to Southern Pacific Railway's notice of withdrawal.—July 23.
- Vaudreuil and Prescott Road, turning of first sod at Rigaud, Que.—July 16.
- Reciprocity, British Columbia Board of Trade at its Annual Meeting declares for it.—July 10.
- Registrars, Quebec, session of provincial registrars.—July 3.
- Rhode Island state senate passes license bill from the House with several amendments.—July 24.
- Rome, information received of an attempt to be made to blow up the Vatican and Quirinal with dynamite, both places doubly guarded.—July 27.
- Roumania, Czar protests against Roumanian Government pushing fortification works *vide* Berlin *Kreuz Zeitung*.—July 6.
- Russell Sir Charles, M. P., and Mr. Asquith, M. P., address political meeting at Hampstead, London, Eng.—July 20.
- RUSSIA, Djarkend in Semirethinsk one half of town destroyed.—July 12.
- France, a definite offensive and defensive alliance concluded between, see Vienna *Allgemeine Zeitung*.—July 23.
- Musulman, government allocates large tract of land to Musulman population of the Kabardah.—July 22.
- Province of Prjevalsk, earthquake destroys 167 houses and wipes out a village.—July 30.
- Ruthven, Ont., well of natural gas set alight.—July 9.
- St. Boniface, Man., subsidence of land on river bank facing Catholic hospital sinks fourteen feet.—July 14.
- St. John, N. B., Carnival, opening ceremonies.—July 22.
- Salisbury Lord, at Mile End, London, speaks on Imperial Federation and the Irish question.—July 16.
- Salt, Northern American Salt Company files articles of incorporation in Secretary of State's office, Albany, N. Y.—July 19.
- Salt Trust, Wheeler E. D., of Manistree, Mich., interviewed at Milwaukee, Wis.—July 15.
- Salt Union issues circular offering shares and debenture bonds of American company to English share and debenture holders.—July 16.
- Salt trust, representatives of, meet at Fifth Avenue Hotel, New York.—July 11.
- Salt, American Salt Company, lists opened in London and New York.—July 22.
- Salt, American Salt Union, Warsaw, N. Y., to be made headquarters, news received with delight.—July 22.
- Salt Trust, Burt W. H., President of North American Salt Company, returns to Saginaw, Mich., and states that the organization of the company as proposed is indefinitely postponed.—July 31.
- Salvation Army, Indianapolis, Ind., attempt to blow up barracks with powder.—July 9.
- SANOA, German gunboat "Wolf" leaves Sydney, N. S. W., to take back King Malletta.—July 4.
- Sir James Ferguson, in British House of Commons, declares that England has agreed to retire from her position as one of the three protecting powers.—July 2.
- Famine in; letter from King Mutsafa to Mr. Kleix printed in New York World.—July 20.
- Scold common, Jersey City, Brady Mrs. Mary, convicted of being.—July 16.
- Scott Act, Egin County, repealed.—July 3.
- School Masters High, of Ontario, convention, at Toronto.—July 31.
- Sea lion, Lake Winnebago, Wis., sea lion eleven feet long captured.—July 22.
- Sealing, Victoria, B. C., schooner "Wanderer" arrives at "Sand Point" with catches of several British sealing schooners totalling 5320 skins.—July 24.
- SERVIA, fifty Russian officers pass Braila Roumania on the way to Servia, reported at Vienna.—July 8.
- Military Council decides to arm 30,000 men of the third levy.—July 13.
- Belgrade, eight Russian officers arrive at.—July 15.
- Government preparing to arm second reserves.—July 16.
- Milan ex-King, in address at Belgrade, disavows any intention of interfering with existing regime.—July 24.
- Brigands, company of gendarmes have fight with marauders in the mountains, five of the robbers and two gendarmes killed.—July 25.
- Ex-King Milan and Regents Belimarkovich, Grutes and Bisties confer together at Pranja Servia on the dynastic question.—July 31.
- Alexander King, anointed at Belgrade by the Metropolitan and other ecclesiastics.—July 2.
- Sewer Pipe Trust, Pittsburg, Pa., in difficulty, not able to make any money assessment.—July 27.
- Seymour Fred. J., manager of American Allumium Company, dies at Findlay, Ohio.—July 13.
- Shah of Persia, London, arrival of.—July 1.
- Shah of Persia arrives at Paris.—July 30.
- Shelton Prof. Edward M., of Monhatten, Kas., appointed, by Department of Agriculture, Washington, instructor in Agriculture to Queensland Government, Australia.—July 19.
- SHIPPING—Canada Shipping Co., action against, by Louis Meyer at Baltimore for \$40,000 for loss of cattle, decided in favor of Defendants.—June 6.
- Aden, French steamer "Anadyr" bound from Marseilles for Yokohama sunk in collision with French steamer "Oxus"—July 11.
- Augustine Creek, Savannah, Ga., steamer "St. Nicholas" runs into closed drawbridge, demolishing forward part of vessel, killing two women, and injuring 28 men and women.—July 20.
- Behring Sea, American schooner "Rush" seizes British schooner "Black Diamond" in Behring sea, British schooner "Triumph" brings news to Victoria, B. C.—July 28.
- Behring sea, capture of "Black Diamond," steamer "Dora" brings first detailed news of capture to San Francisco.—July 30.
- Boston, fishing schooner "Edith Emery" arrives with only three of her crew of 19 men, others went in boat to tend trawls and did not return.—July 16.
- Bramble v. Strait, American ship "Rosie Welt" from Newcastle N. S. W., or Singapore wrecked.—July 20.
- British Government accepts tenders for construction of 17 vessels on the Clyde, Tyne and Mersey.—July 18.
- Canadian Atlantic mail service undertaken by Messrs. Anderson, of London, signed at Ottawa.—July 16.
- Causo, Government despatch boat from Sable Island brings crew of the barque "Fearless" of Newport, Wales, wrecked on the island.—July 20.
- Cape Breton "Mattie Winship" of Gloucester, Mass., fishing schooner seized for fishing within three-mile limit sends word to Department of Justice that no defence can be offered.—July 12.
- Cleveland, Ohio, schooner "Kate Winslow" sailed into port with two Canadian mates, contrary to the statute. The Customs fined owners \$349.—July 24.

## SHIPPING.—Continued.

Congo, Telegram from Governor General states that English steamer "Loulaba" from Liverpool ascends the Congo as far as Matadi.—July 4.

Dominion government arrive at agreement with Mr. Anderson respecting proposed fast line steamship service.—July 2.

East Greenleaf, letter received at New London, Conn., from whaling schooner "Sarah W. Hunt" dated June 28, says a boat's crew in command of mate John Sharp lost while fast to a whale which "sounded."—July 23.

"Etruria" steamship, tria' by jury conducted by the passengers.—July 14.

Gloucester, Mass., schooner "Golden Hind" arrives with two men of French schooner "Georges" picked up on June 13 off Sable Island.—July 11.

Halifax, "Ida May," American schooner, permission granted to sell her fresh halibut, the permission not to be taken as a precedent.—July 19.

Koenigsberg, Germany, English steamer "Fortona" burned.—July 12.

Liverpool, boarding house keeper fined for furnishing bogus seamen to White Star Line steamer.—July 1.

Los Angeles, "Mara" Red Line steamer from New York to Lagunaza totally shipwrecked, but crew saved.—July 9.

"Mailai" steamer from Gilborne for Auckland strikes on rocks and sinks, purser Larsen and cook drowned.—June 1, reported July 8.

Malta, British warship "Sultan" raised.—July 26.

Marquette, Mich., propeller "Smith Moore" collides with propeller "Jane Pritchard," and sinks, crew saved.—July 13.

Matane, P. Q., steamer "Lenuria" from Havana ashore making water.—July 10.

"Matte Winship" seized off Sydney, C. R., for illegal fishing, Governor-General approves recommendation of Minister of Fisheries for settlement.—July 23.

Middleton Reef, British bark "Mallgate" from Newcastle, N. S. W., for San Francisco wrecked.—July 30.

Missing barque "Mary P. Ritchin," information reaches Philadelphia from London through Lloyds that the "Ritchin" arrived at Montevideo on May 2nd under the name of the "Kissan."—July 25.

Montreal, Kingston and Montreal Forwarding Company's barque "Eva" sunk at the wharf Hochelaga.—July 6.

Montreal Transportation Company, steamer "John Gaskin" of Kingston, seized for having repairs done in United States and not reporting to Customs.—July 16.

New Bedford, Mass., whaling schooner "Franklin" arrives with the crew of seaman "Lorenzo D. Baker" from Point Antonio, Jamaica, for Boston, burned at sea.—July 22.

New Bedford, Mass., barque "Mary Frazer" abandoned at sea. Capt. Latham arrives from Payat, and describes loss of five men off Island of Flores.—July 25.

New York, Pacific Mail Steamship Company notifies Transcontinental Association, that unless the subsidy from railroads increased they will cut rates and take all the freight they can get.—July 26.

New York, new turn screw steamship "Columbia" completes her maiden passage from Southampton in 6 days, 21 hours, 37 minutes from the Needles.—July 26.

New York, steamship "Columbia" arrives, having come from Southampton to Sandy Hook in 6 days, 21 hours, 23 minutes.—July 27.

New York, steamer "City of Paris" arrives at Sandy Hook light ship, having completed journey in 5 days, 23 hours and 10 minutes.—July 21.

New York, steamer "Westerland" detained in quarantine.—July 17.

Nova Scotia, barque "Harriet Campbell" of Weymouth abandoned on May 31st, while on voyage from Moville to Buenos Ayres, the crew rescued by Norwegian barque "Adelphine" and landed at Sydney.—July 18.

Old Man Island, two miles south of Cutter Harbor, Spanish steamer "Eduardo" from Boston strikes on island and fills with water.—July 21.

Ortonville, Minn., steamship, "F. D. Underwood" destroyed.—July 13.

Palawan Island of British steamer "Alma Craig" from Hilo for America strikes a rock and fills with water.—July 20.

"Pontecorco" bark, outward bound from Quebec to Glasgow, goes ashore on Beumont shoals.—July 4.

Quebec, Norwegian barque "Prince Eugene" arrives here with two fishermen Nicholas Phillipot and John Luck picked up on the banks.—July 17.

San Francisco, survivors of whaling barque "Little Ohio" arrive and state the vessel struck near Point Hope during severe snow-storm.—July 31.

Steamer "Emete" of Boston seized for landing liquors at Campobello, N. B., without reporting.—July 16.

St. Marys, Mo., Anchor Line steamer "Crystal City" reported to have sunk in Mississippi river.—July 11.

## SHIPPING.—Continued.

"Aria, R. C., sealing schooner "Wanderer" arrives from Sand Point with catches of several British sealing schooners totalling 5320 skins.—July 24.

Welland Canal, propeller "Haskell" of Central Vermont line runs into lock No. 16 carrying both gates away.—July 29.

Whaling schooners, the "James A. Hamilton," "Otter" and "Annie" lost in the Arctic. News from Oumalaska by steamer "Bertha" confirms the report.—July 24.

Wilmington, N. C., steamer, "Queen of St. John's" burned to water's edge.—July 10.

Slander, trial of action William O'Brien, M. P., against Lord Salisbury begins in London, Eng.—July 19.

Slander, O'Brien, Salisbury case, verdict for Lord Salisbury.—July 20.

Slander, O'Brien W., M. P., against Lord Salisbury, O'Brien applies for a new trial.—July 31.

Smallpox, New York steamer "Westerland" detained in quarantine.—July 17.

Small pox, Buffalo, Newton Slick, employed by Palace Car Company in cleaning out cars, stricken and removed to pest house.—July 15.

Smith Egbert Tangiers, large landowner at Patchogue, L. I., death of.—July 7.

Smuggling, New York, Maria Vincenz Cheri Carrachen, arrives on steamer "Novestria," her bustle found to contain large quantity of jewellery.—July 29.

Socialism, Paris, International Socialist Congress opened at.—July 15.

Socialists, Swiss, decide to send a protest to the Bundesrath against the action of the Procureur-General in regard to German refugees.—July 18.

SPAIN and Great Britain, extradition treaty of 1878 between, amended by adding clause to include persons charged with indecently assaulting girls under sixteen years of age.—July 26.

Pope, Government forbids demonstrations calculated to encourage the Pope to come to Spain in the event of his leaving Rome.—July 20.

SPORTS—Aquatics, Henley Regatta, Paotta, American champion beats Blackmore, English sculler, in diamond scull race.—July 3.

Aquatics, Henley regatta, Eng., race for diamond sculls.—July 5.

Baseball, Owensboro, Ken., a fight ensues on decision of umpire Ben Bates who fatally stabs Frank Morris.—July 21.

Baseball, New York, Washington at Washington, the police raid the "bleaching boards" and arrest five persons for gambling on the game.—July 30.

Bicycling, Hagerstown, Ind., tenth annual meeting of American wheelmen closes.—July 4.

Boxing, Chicago, boxing match for benefit of Braidwood strikers degenerates into a prize fight.—July 11.

Bullfight, Paris exhibition, stopped by the police.—July 9.

Carnival, St. John, N. B., opening ceremonies.—July 22.

Billiards, Paris, Eugene Carter beats M. Vignaux, champion, at game of cushion caroms.—July 22.

Cricket, England, gentlemen of Kent defeat Philadelphia team.—July 26.

Cricket, London, Eng., Metropolitan Cricket Club plays the American eleven.—July 22.

Lacrosse, Montreal, the Shamrocks defeated by the Cornwalls.—July 15.

Lacrosse, Ottawa, beat Shamrocks at Ottawa.—July 1.

Lacrosse, Montreal beats Cornwall team at Cornwall, Ont.—July 20.

Lacrosse, Ottawa's defeat Toronto team.—July 20.

Lacrosse, Steue Island team beaten by Montreal team at Montreal.—July 27.

Lacrosse, Toronto team beats Shamrock team at Toronto.—July 27.

Racing, Goodwood, Steward's cup won by James' "Dog Rose."—July 30.

Racing, Goodwood, Chesterfield cup won by Legh's "Veracity."—July 31.

Racing, Leicester summer meeting, Portland stakes won by "Riviera," Appleby plate won by Needles.—July 17.

Racing, Sandown Park, Eclipse stakes for 1,000 sovereigns won by "Ayrshire."—July 19.

Racing, Newmarket, Chesterfield stakes won by "Heanna."—July 11.

Ring, Sullivan-Kilrain, Governor Lowry of Mississippi forbids fight and offers reward for their arrest.—July 2.

Ring, Sullivan-Kilrain fight takes place at Richburg, Marion County, Miss.—July 8.

Ring, Nashville, Tenn., Sullivan and Johnson released on writ of Habeas Corpus, reward issued for arrest of Kilrain by Governor Lowry of Mississippi.—July 11.

Ring, Nashville, Tenn., Sullivan John, arrested on a requisition from Governor of Mississippi.—July 11.

Ring, Sam Smith challenges Sullivan to fight in Europe for £1,000 a side.—July 9.

SPORTS—*Continued.*

Ring, Kilrain-Sullivan fight, Purvis, Miss., aiders and abettors appear at court and are bound over.—July 18.

Ring, New York, warrants for arrest of Charles Mitchell and Michael Donovan applied for.—July 18.

Ring, Purvis, Miss., Sullivan-Kilrain fight, Rich C. W., and Jameson J. T., of Lauderdale County, arrested on charge of abetting.—July 15.

The ring, Indianapolis, Ind., prize fighters picnic ends in a disgraceful scene.—July 21.

The Ring, New York, Sullivan John L., arrested at the Vanderbilt Hotel, on requisition from Governor of Mississippi.—July 31.

Rowing, Senle and O'Connor meet at Star and Garter Hotel, Richmond, and arrange preliminaries for race.—July 17.

Rowing, London, Searle and O'Connor meet at Albert Hall, to make final arrangements.—July 8.

Trotting, Glenville, Ohio, "Guy," famous black Gelding, trots a mile in 2.11½ beating his record.—July 10.

Trotting horses, Louisville, Ky., L. L. Dorsey's stock of, sold at Highland's stock farm.—July 29.

Water Walking, Prof. Oldrieve walks from Pemberton to Boston.—July 29.

Yachting, Cinque Port Yacht races, "Paradox" badly beaten.—July 22.

Yachting, London Yacht Club, regatta, "Valkyrie" wins.—July 31.

Yachting, London, Mad Hook Club, annual regatta over Clyde course, the Yarana wins.—July 3.

Yachting, Rothsay, Scotland, "Valkyrie" beats "Yarana," "Irex" and "Marjorie" over fifty mile course.—July 2.

Yachting, Royal Clyde Regatta, The Valkyrie wins.—July 8.

Yachting, St. Lawrence Yacht Club race for Vice Commodore's cup won by Lulu.—July 6.

Yachting, Kingston regatta, the "Zarana" beats the "Valkyrie."—July 17.

Yachting, Marble Head, Mass., annual races of Eastern Yacht Club.—July 15.

Yachting, New York Yacht Club resolves not to put up special cup for competition in a match race with the "Valkyrie."—July 18.

Spring Valley, Ill., Coal Co., 150 employees occupying tenement houses served with notice to quit.—July 22.

Standard Oil Company, says the New York *World*, has bought up all the white lead companies in the United States.—July 31.

Stanley H. M., West Africa, advices from, confirm reports as to shocking, privations endured by.—July 1.

Steel and Iron trades, Chicago, firm patents an invention which competent judges say will revolutionize steel and tin industry.—July 21.

Stock Exchange, New York, quotations members decide to send prices forward through the Gold and Stock Telegraph company, immediately upon transactions taking place.—July 24.

Storm, Ashland, Wis., severe damage, 700,000 feet of lumber blown off the dock into the bay.—July 27.

Storms, Chicago, all kinds of property suffer, total loss in excess of a million dollars.—July 27.

Storm, Cronsberg, Watertown, S. J., wind storm wrecks the village, two children reported killed.—July 7.

Storm, Evansville, Ind., great damage, persons nearly killed by electricity.—July 14.

Storms, Fayetteville, Ark., several residences, and livery stable of Kell and Hagen destroyed, residence of Thomas Holland blown to pieces.—July 28.

Storm, Hamilton, Ont., severe thunder and rain storm, loss estimated at \$41,000.—July 1.

Storms, Haverhill, Mass., trees uprooted, fences levelled, houses unroofed and blown down.—July 30.

Storm, Kansas City, O'Connor Hannah, aged 2 years, killed by lightning.—July 15.

Storms, Morristown, Minn., two large barns demolished and other buildings unroofed.—July 25.

Storms, Newark, N. J., great destruction of property, immense dam at Westfield back of Scotch Plains collapses.—July 30.

Storm, Peshtigo, Wis., windstorm does much damage to buildings and crops.—July 18.

Storm, Princeton, Butler county, Ohio, the village nearly demolished.—July 14.

Storm, Switzerland, Genaris, iron bridge and portion of railway destroyed, man killed.—July 16.

Storms, West Virginia, damage and loss at Little Kanawha Valley, Little Tygart Valley and other places.—July 18.

Strawboard makers of United States unite to trust under name of The American Straw Board Company.—July 24.

STRIKES, street employees, Duluth, strikers attack the police compelling them to fire. Two strikers killed and several wounded.—July 6.

Bakers, Brunn, increase of 30 per cent. in wages demanded.—July 2.

Bakers, Berlin, collapse of strike.—July 22.

Brosnan, trial of strikers at Berlin results in conviction of 32.—July 25.

Carnegie steel works, train bringing non-union men stopped at Homestead, Pa., and men prevented entering works.—July 11.

Carpenters, Payne, give notice of an intention to strike unless their demands for an increase in wages are conceded.—July 25.

Coal Heavers, Duluth, demand for increase from 40 to 50 cents per hour.—July 22.

Coal heavers, Superior, Wis., Lenigh Coal Company heavers walk out and refuse to handle coal at less than fifty cents an hour.—July 18.

Coal Heavers, West Superior, Wis. The strikers drive men from work on barge "Iron King."—July 19.

Compositors, New York, men on *Herald*, *Sun*, *Times*, and *World* strike rather than submit to reduction of ten per cent wages.—July 24.

Compositors, New York, dispute between Typographical Union No. 6, New York, and three morning papers settled.—July 30.

Iron Mills, Philadelphia Rolling Mill Association and Amalgamated Association agree on wage schedule.—July 1.

Miners, Braidwood, Ill., Knights of Labor, executive board at Chicago decides to issue call for money to aid strikers.—July 22.

Miners, Dortmund, leaders of rioters sentenced to terms of imprisonment.—July 2.

Miners, Portland, meeting to discuss renewal of strike degenerates into a fight, which is stopped by cavalry who arrest ringleaders.—July 17.

Miners, Geitz district, authorities at Vienna receive information that striking miners are conspiring to blow up public buildings and residence of mine owners and managers. The Government takes precautions and arrests eight of the agitators.—July 29.

Miners, Germany, Voitsberg district, become general, military kept in readiness to quell any disturbance.—July 17.

Miners, Lieben Stryll, all small tradesmen and civic fire brigade make common cause with strikers, a reign of terror prevails.—July 18.

Miners, coal, Altoona, Pa., 40 miners representing 14,000 meet and decide not to enter into general suspension but call out all working under district prices.—July 8.

Miners, coal, Braidwood coal region, Ill., the sheriff summons posse to protect 75 miners who sign agreement to resume work.—July 11.

Miners, Kangley near Streator, Ill., riotous proceedings on behalf of riot strikers, on working miners.—July 28.

Miners, coal, Lellico, Tenn., 1000 miners resume work.—July 8.

Miners, coal, Saar mines, workmen on strike owing to the dismissal of delegates who attended miners conference.—July 9.

Miners, coal, Streator, Ill., decision to settle by arbitrator.—July 9.

Moulders, Gal., t. t., moulders organize and demand a uniform rate of wages.—July 6.

Nail makers, Staffordshire strike for advance in wages.—July 8.

Riveters, Clyde shipyards compromise with their employers and lock-out withdrawn.—July 11.

Shipbuilders, Clyde, notice of lock-out given to force strikers to return to work.—July 9.

Sailors, Liverpool, the men accept the terms of the employers.—July 12.

Seamen, Liverpool, strikers decide by ballot to continue the strike until the companies grant their demands.—July 8.

Shoe shops, North Adams, Mass., strike settled, all shops to be union, men go to work.—July 8.

Silk operators, Paterson, N. J., strike against reduction of wages.—July 18.

Spinners, Austria, six thousand at Brunn resume work.—July 11.

Steel works, Carnegie, Phipps & Co., at Homestead Pa., the town in the possession of the strikers, a hundred Pinkerton men arrive.—July 12.

Steel workers, Homestead, Pa., conference held between amalgamated officials, and the firm of Carnegie, Phipps & Co. arrive at a virtual settlement of the trouble.—July 14.

Tramway employees, Curditt, rioting and arrest of several rioters.—July 1.

Weavers, Jaegersdorf, 4000 strike.—July 8.

Weavers, Zurtan, at Brunn, Austria, obtain the advance they desired.—July 13.

Sugar, Magdeburg sugar ring collapses.—July 12.

Sugar, Trust, New York, heavy decline in certificates.—July 12.

Sugar trust, St. Joseph, Mo., refining company absorbed by and closes down for three years.—July 10.

Sugar, Brazil, consul Armstrong at Rio Janeiro, in report to State Department at Washington, says Brazil is anxious to secure in United States a market for its sugar.—July 20.

**SUICIDE**, Bayonne, Hudson County, N. J., Miss Leoni Stenvenia attempts, to crucify herself while suffering from religious mania.—July 4.  
 Chicago, attempted by James Smith, found guilty of criminally assaulting an 8 year old girl.—July 27.  
 Copenhagen, Count Sparre shoots himself.—July 23.  
 Germany, Acton Lady, sister of German ambassador, at Washington, drowns herself.—July 13.  
 Guelph township, Dyson Isaac, prominent farmer and director of Guelph Fat Stock Club, hangs himself.—July 22.  
 Jackson County, West Pa., Misses Annetta and Miriam Boggs, sisters, commit suicide by taking arsenic.—July 18.  
 Munich, Count Waldemar Von Blumenthal, Russian military attaches shoots himself.—July 13.  
 New York, Waters Dr. John W., takes poison.—July 8.  
 Ormstown, P. Q., Carley James, a farmer, commits suicide, whilst insane.—July 1.  
 Ottawa, Robson Miss, daughter of late Captain Robson, shoots herself while in state of mental aberration.—July 29.  
 Palouse City, W. T., Johnson R. D., shoots himself after killing his family.—July 6.  
 Rockford, Ill., Susemith Mr. and Mrs. George, aged over 75 years, jump into the river and are drowned.—July 19.  
 Steamer "Montreal" near Sorel, P. Q., man unknown jumps overboard.—July 6.  
 Toronto, Orr Mrs. William, cuts her throat.—July 12.  
 Toronto, Lillie Kelly, arrested for being drunk and disorderly, hangs herself in her cell.—July 27.  
 Youngstown, Ohio, Mrs. John McGregor, deserted by her husband, drowns herself in a creek.—July 18.  
**Sunday School Convention** opens in London, Eng.—July 2.  
**SWITZERLAND**, Government decides to establish embassies at London and St. Petersburg.—June 13.  
 Germany, the reply of Swiss Bundesrath received at Foreign office, Berlin.—July 14.  
 Bundesrath postpones International labor congress at Berne until the spring.—July 15.  
 Geary, Iron bridge and portion of railway destroyed by storm, man killed.—July 16.  
 Socialists decide to send a protest to the Bundesrath against the action of the Procurer General in regard to German refugees.—July 18.  
 Government expels large number of Nihilists, French Anarchists and German Socialists residing at Geneva without regular papers.—July 23.  
**TELEGRAPHS**, Mackay-Bennett, and French Cable Companies amalgamate, reported in Halifax.—July 8.  
 United States, rate fixed by Government at one mill per word instead of one cent.—July 11.  
 Telephones, France, Chamber of deputies adopt bills for purchase of.—July 10.  
 Telephones, Bell Telephone Company against Crishman Telephone Companies, final decree rendered by Judge Blodgett in Federal Court, Chicago.—July 24.  
 Terminal City Company, Limited, sale of a block of 100,000 shares of the company's treasury stock in London, Eng.—July 19.  
 Texas fever, Cherokee strip, epidemic among cattle.—July 16.  
 Texas fever, Indian territory and Oklahoma, cattlemen report it to be playing havoc among the cattle.—July 29.  
**THEATRICAL**, London, Eng., Sara Bernhardt appears as Lena Despard, at Lyceum Theatre.—July 9.  
 Title "Honorable," colonial under-secretary, in British House of Commons says Colonial office issued no new regulations regarding use of.—July 9.  
 Trades and Labor Council, Toronto, annual election of officers, etc.—June 19.  
 Trades Council, Birmingham, Ala., eliminates the Knights of Labor from the organization.—July 28.  
 Tripoli, Governor of, issues decree abolishing slave trade.—July 4.  
**TRUSTS**, Gas, Chicago, English syndicate endeavoring to purchase gas trust's plant.—July 12.  
 Labor Congress, Paris, resolutions passed calling upon Governments to oppose.—July 22.  
 Mills, Minneapolis, English syndicate combines to purchase several of the largest mills.—July 11.

**TRUSTS.—Continued.**

Paper manufacturers, English Syndicate completes arrangements for proposed combination.—July 19.  
 Salt, Wheeler E. D., of Manistee, Mich., interviewed at Milwaukee, Wis.—July 15.  
 Salt, issues circular offering shares and debenture bonds of American Company to English shareholders and debenture holders.—July 16.  
 Salt, representatives of, meet at Fifth Avenue Hotel, New York.—July 11.  
 Salt, American Salt Union Warsaw, N. Y., to be made headquarters news received with delight.—July 22.  
 Salt, Burt W. N., President of North American Salt Company, returns to Saginaw, Mich., and states that the organization of the Company as proposed is indefinitely postponed.—July 31.  
 Sewer pipe, Pittsburg, Pa., in difficulty, it is not able to make any money assessment.—July 27.  
 Straw box makers of United States unite in trust under the name of "The American Straw Board Company."—July 24.  
 Sugar, St. Joseph, Mo., refining company shuts down for three years.—July 10.  
 Sugar, Magdeburg, Sugar ring collapses.—July 12.  
 Sugar and Lead, heavy decline in certificates at New York.—July 12.  
 Tyler Mrs., wife of ex-President John Tyler, dies at Richmond, Va.—July 11.  
 Turkey, negotiations with, result in an entente, under which the Triple Alliance guarantees to maintain the integrity of Turkish territory in accordance with treaty of Berlin.—July 29.  
 Turnverein contest, Munich.—July 31.  
 Tye James G., publisher and proprietor of Watford *Guide Advocate*, dies at Watford, Ont.—July 30.  
 Typhoid fever, Wilkesbarre, Pa., epidemic of, prevails at.—July 3.  
 United Cotton Spinners, Manchester; council meets and resolves all spinners shall reduce production by one half for a month.—July 9.  
**UNITED STATES**, Senate commission on Interstate Commerce, Boston, sitting at.—July 6.  
 Senate committee on Indian affairs arrives at Juneau, Alaska.—July 21.  
 Treasury, Washington, count of the cash and securities incident to the transfer of the office from Mr. Hyatt to Mr. Huston completed.—July 27.  
 Upper Guinea, English removes the French flag from house of Sultan Bomitonkoo at Grand Bassam, Upper Guinea.—July 3.  
 Vancouver, City Land Company, Ltd., to acquire real estate in Vancouver registered in London.—July 8.  
 Vancouver, oil discovered in centre of city.—July 17.  
 Watersport, Altoona, Pa., much damage done.—July 2.  
 Watrous Hon. Geo. H., ex-president of New York, New Haven and Hartford Railway, death of, at New Haven, Conn.—July 5.  
 Wedding golden, London, Eng., Gladstone Rt. Hon. W. H. and Mrs., celebrate.—July 25.  
 Welland Canal, propeller "Haskell" of Central Vermont line runs into lock No. 16, carrying both gates away.—July 29.  
 Welland Canal, Wood A. F., M.P.P., appointed commissioner to examine into charges of irregularities in management.—July 2.  
 Wesleyan conference, London, opening of.—July 23.  
 Wheat and rye, Vienna and Buda-Pesth, large rise in prices.—July 4.  
 White lead companies, in the United States, New York *World* says Standard Oil Company has brought up all of them.—July 31.  
**WIMBLEDON**, London Corporation and other prizes shot for.—July 15.  
 National Challenge trophy won by English rifle team.—July 15.  
 Queen's prize woo by Private Reid of First Lanarkshire regiment.—July 16.  
 Kolarup cup won by Canadian team.—July 17.  
 Elcho Challenge shield won by Irish team.—July 18.  
 Stewart contest won by Corporal W. D. Huddleston of Massachusetts team.—July 18.  
 Wolfe Islands, Ont., cattle seized by customs officers for bringing over animals kept in United States during the winter.—July 6.  
 Wool, English, Pittsburg, Pa., appraisers decide to admit at ten cents a pound instead of thirty or sixty cents.—July 23.  
 Woolsey, ex-president of Yale College, death of.—July 2.  
 World's Sunday School Convention opens in London, Eng.—July 2  
 Yellow fever, Aspinwall, outbreak at.—July 17.



The Oldest and Largest Roller Casting Estab-  
lishment in New England.

ESTABLISHED 1859

**WILD & STEVENS,**

MANUFACTURERS OF

Printers' Rollers and Roller Compositions,

No. 148 CONGRESS STREET, BOSTON.

**WEBSTER**

In various Styles of Binding, with and without  
Patent Index.

The Latest Edition has **118,000 Words**, and **3,000 En-  
gravings**,—3000 more Words and nearly 2000 more Engravings  
than found in any other American Dictionary. It also contains a  
**Biographical Dictionary**, giving brief facts concerning nearly  
**10,000 Noted Persons**. To these features we have

**JUST ADDED (1885),**  
A NEW PRONOUNCING

**Gazetteer of the World,**

containing over 25,000 Titles,  
*briefly describing the Countries, Cities, Towns; and Natural  
Features of every part of the Globe.*

**WEBSTER IS THE STANDARD**

Authority with the U. S. Supreme Court and in the Gov't. Printing Office  
and is recommended by the State Sup'ts of Schools in 36 States, and by  
the leading College Presidents of the United States and Canada.

THE LONDON TIMES says: It is the best Dictionary of the Language  
THE QUARTERLY REVIEW, LONDON, says: it is the best practical  
Dictionary extant.

THE CALCUTTA ENGLISHMAN says: It is the most important  
work of the kind.

THE TORONTO GLOBE, CANADA, says: Its place is in the very  
highest rank.

THE NEW YORK TRIBUNE says: It is recognised as the most useful  
existing "word-book" of the English language all over the world.

It is an invaluable companion in every school, and at every fireside.  
Specimen pages and testimonials sent prepaid on application.

**G. & C. MERRIAM & CO., Publishers,**  
Springfield, Mass., U.S.A.

**Photo - Engraving.**



**Pen Drawing & Map Etching.**

  
 WHEN  
**YOU \* ARE \* READY**  
 To order any more  
**BINDING**  
**PLEASE CALL UP**  
**TELEPHONE \* 230**  
 Or send a POSTAL CARD to  
**JOHN LOVELL & SON,**  
 23 & 25 St. Nicholas St., Montreal  
 Best work at mo-  
 derate pri-  



## WHO SUBSCRIBE TO THE

## "INDEX OF CURRENT EVENTS."

The "Index of Current Events" is much appreciated not only by the press of Canada and the United States, but also by the public men of both countries. Its list of subscribers includes such great newspapers as the Philadelphia *Ledger*, the Boston *Transcript*, the New York *World*, the Cincinnati *Enquirer*, the Brooklyn *Eagle*, the Toronto *Empire*, the Cleveland *Leader*, the Chicago *Herald*, the Cincinnati *Post*, the New York *Morning Journal*, the Chicago *Daily News*, the Indianapolis *Journal*, the New York *Star*, the Troy *Budget*, the Chicago *Staats Zeitung*, the New York *Nation*, the Troy *Press*, the Washington *Star*, the Chicago *Inter-Ocean*, and many less known but important newspapers. Some of these papers are well known to keep admirable indexes of their own, yet find it advantageous to subscribe to the INDEX OF CURRENT EVENTS. We have the honor to include among our subscribers, Her Majesty's Privy Council for Canada; also, Sir John Macdonald, G. C. B. Premier of the Dominion, Sir Hector Langevin, Minister of Public Works, Sir A. P. Caron, Minister of Militia, the Hon. G. E. Foster, Minister of Finance, the Hon. Mackenzie Bowell, Minister of Customs, the Hon. J. A. Chapleau, Secretary of State, the Hon. John Costigan, Minister of Inland Revenue, the Hon. John Haggart, Postmaster, General, the Hon. John Carling, Minister of Agriculture, the Hon. C. H. Tupper, Minister of Marine and Fisheries, the Hon. Commissioner of Agriculture and Colonization Quebec, the Hon. Boucher de La Bruère, late speaker of the Legislative Council, Quebec, the Hon. Lieutenant Governor Royal, Mr. Erastus Winan, the Hon. Minister of Public Works, Toronto. The Librarian of Parliament, the House of Commons Reading Room and the Librarians of many of the Provinces of the Dominion and States of the Union subscribe to the *Index*. Among the well known public librarians who subscribe are, Mr. J. C. Hurlbut, Librarian of the American Geographical Society, New-York, Mr. W. A. Bardwell, Librarian of the Brooklyn Library, Mr. W. H. Brett, Librarian of the Cleveland Public Library, Mr. F. P. Jordan, Librarian of the Public School Library, Battle Creek, Michigan, Mr. W. T. Peoples, Librarian of the Mercantile Library, New-York, Mr. Robert E. Rich, Librarian of the Public Library, Portsmouth, N.

H., Mr. J. P. Dunn, Librarian of the Indiana State Library, Indianapolis, Mr. F. W. Vaughan, Librarian of the Social Law Library, Boston, Mr. James G. Barnwell, Librarian of the Philadelphia Library, the Librarian of the Providence Public Library, the Librarian of the Free Public Library, San Francisco, Mr. John M. Doane, State Librarian of Ohio, Mr. William H. Egle, State Librarian of Pennsylvania, Mr. M. Chamberlain, Librarian of the Boston Public Library, Mr. A. W. Whelpley, Librarian of the Cincinnati Public Library and Mr. C. B. Tillinghart, State Librarian of Massachusetts. The leading bankers (including the Bank of Montreal), brokers, lawyers and hotel keepers of Canada, and many clergymen also keep the *Index* on file.

What is thought of the *Index* may be gathered from the numerous entirely unsolicited expressions of approval sent in by well known public men, of which the following are specimens:

MR. MARTIN J. GRIFFIN, LIBRARIAN OF PARLIAMENT, OTTAWA, writes I am sending you a subscription for two copies of your "*Index*," which will be most useful and which deserves encouragement. If you will take particular pains to give the dates and figures of elections and the dates of speeches of public men, with reference also to the places at which the speech was delivered, you will do a very grateful thing for public people and editors, and I may add librarians.

MR. JOHN M. DOANE, STATE LIBRARIAN OF OHIO, writes:—Enclosed please find six dollars, in payment for State Librarian subscription to the "Index of Current Events" for 1889.

I regard it as a very valuable publication, and hope that you may meet with such success as warrant its continuance, for it will grow more valuable every year.

MR. HERRIES, OF THE BROOKLYN *Eagle*, writes:—"I congratulate you most heartily upon having done a good thing, a very good thing, in starting the "*Index*" enterprise. I hope I may have the joy of congratulating you upon your success a year hence. A man with *Index* on the brain is one after my own heart. My judgment was formed upon Number 1; if the indexing is kept up as thoroughly in all subsequent numbers it will be a great help to us."

SIR CHARLES TUPPER, BART., HIGH COMMISSIONER FOR CANADA, writes:—It seems to me to be a very useful publication, and one that will be valuable for reference purposes."

MR. BARK, ASSOCIATE EDITOR OF THE PHILADELPHIA *Public Ledger* writes:—"Your *Index* is highly appreciated at this office, where it has long been a desideratum."

MR. COLQUHOUN OF THE "TORONTO *EMPIRE*," writes:—"Allow me to congratulate you most cordially upon your admirable *Index*. The idea and its execution are alike worthy of all praise."

MR. VALEN, OF THE "NEW-YORK *MORNING JOURNAL*," writes:—"I find the *Index* of great value, saving, as they do, much valuable time in looking up important events."

MR. WILL A. WOODWARD, REC. SEC. MASS. PRESS ASSOCIATION, writes: Enclosed please find subscription for one year for "*Index of Current Events*." I have examined the specimen sent me with much interest and do not hesitate to commend it as an invaluable assistant in the newspaper office. The amount of time and labor it is calculated to save, cannot be compensated by one hundred times its subscription rate.

Commencing with Vol. II No. I the dates given in the *Index* are the actual dates of the occurrences; not as formerly the dates of publication.

The *Index* is published four times a month; but to form a complete file for the year it is necessary to preserve only the first issue in each month.

The immediate issues contain the news of the current month to date.

The subscription is \$6 per annum, payable yearly or half yearly in advance. Remittances should be made to

HENRY DALBY,

P. O. Box 864,

MONTREAL, Q. B.

## INDEX OF CURRENT EVENTS.

VOL. II. No. 32.

MONTREAL, SEPTEMBER 6, 1889.

\$3.00 PER ANNUM.  
PUBLISHED WEEKLY.

## AUGUST.

Abyssinia, Godflessi General Rao Alula defeated at, by Italian General Baldissera.—Aug. 21.

ACCIDENTS.—Baseball, Weir City, Mo., James Hamilton, the pitcher, breaks his arm in delivering the ball.—Aug. 3.

Bears, Annapolis, Round Hill, bear kills and eats a boy while out blackberrying.—Aug. 1.

Drowning, Lake Champlain, North Hero Island, Dr. Otta Ritzmann of Albany drowned at.—Aug. 21.

Drowning, Mitchell, Mo., during a storm, spring wagon containing a family of five blown into creek, and occupants drowned.—Aug. 5.

Drowning, Zouhal, N.B., Mrs. MacMurphy, the wife of Archibald MacMurphy, principal of the Collegiate Institute, Toronto, drowned whilst bathing.—Aug. 5.

Explosion, Brownsville, Me., Edgar S. Howard fatally injured by explosion of dynamite cap whilst playing baseball.—Aug. 7.

Explosion, Buckley's Mills, Va., mining blast explodes, Michael Dance and others killed.—Aug. 22.

Explosion, Doman, Hungary, of dynamite cartridge, 5 persons killed.—Aug. 19.

Explosion, Erie, Pa., engine of a Lake Shore freight, and \$50,000 worth of property destroyed by explosion of oil tank. Engineer Loftus and Station Master Kennedy injured.—Aug. 22.

Explosion, Gainville, Texas, Scruggs & Whaley's flour mill at, wrecked by.—Aug. 21.

Explosion, Heeler, Ont., at R. Forbes Company's Woollen Mills, Mr. Weaver and Mr. Hueter seriously hurt.—Aug. 8.

Explosion, Olyphant, Pa., General Superintendent Nicoll, jun., of Delaware & Hudson Canal Co., and 4 workmen killed, in shaft No. 2 at.—Aug. 22.

Explosion, St. Lambert, P.Q., explosion on Grand Trunk train, death of express messenger Rodgers.—Aug. 2.

Explosion, St. Louis, Mo., several persons injured by explosion of fireworks at representation of Siege of Sebastopol.—Aug. 7.

Explosion, Shanghai, China, of boiler on steamer, killing 30 persons.—Aug. 19.

Explosion, South Towanda, Pa., boiler bursts in factory of Godcharles & Co., at, seven killed, others injured.—Aug. 27.

Fire, Allena, Mont., forest fires cause immense damage.—Aug. 19.

Fire, Ancaster Township, Ont., Mrs. Adams, aged 75, burnt to death.—Aug. 1.

Fire, Buffalo, L. B. Crocker's steam yacht burnt, three of Mr. Crocker's children lose their lives, and one badly burnt.—Aug. 7.

Fires, Chicago, Burton building gutted, two men killed.—Aug. 14.

Fires, Danbury, Conn., three more cases of incendiarism occur.—Aug. 3.

Fires, Idaho, heavy timber fires in Wood River country.—Aug. 1.

Fires, Melickatla, Wm. Duncun's saw mills destroyed by.—Aug. 23.

Fires, Miles City, great prairie fires.—Aug. 15.

Fires, Mount Forest, Ont., Yeoman's Mills, and bridge over Saugeen River destroyed.—Aug. 4.

Fires, Nansimo, B.C., East Wellington Colliery on fire at.—Aug. 21.

Fires, New York, nine persons lose their lives by burning of tenement house.—Aug. 19.

Fire, Pratt Mines, of Tennessee Coal, Iron and Ry. Co., shaft No. 1 on fire.—Aug. 2.

Fires, Ripley, Ohio, damage to the extent of \$200,000.—Aug. 2.

Fire, St. Catharines, Ont., Phoenix and Empire flour mills of Sylvester Nelson at, destroyed by; damage over \$100,000.—Aug. 23.

Fires, Spokane Falls, San Francisco Northern Pacific depot, Pacific Hotel and other buildings destroyed.—Aug. 4.

Fire, Spring City, Pa., American Wood Paper Company, works destroyed by fire, one man killed, four injured, damage \$90,000.—Aug. 31.

Fire, Tecumseh, Ont., house of Rector Robinet destroyed by, loss \$8,000.—Aug. 29.

Fires, Tonawanda, N.Y., 3,000,000 feet of lumber destroyed in Golkin yards, loss \$70,000.—Aug. 20.

Fires, Trackee, Cal., east end of town destroyed, loss \$75,000.—Aug. 13.

## ACCIDENTS.—Continued.

Gun explosion, Yarmouth, N.S., practice gun explodes, killing James Cosman.—Aug. 6.

Lightning, Matamoras, Mex., Carlos Rosendey and three other boys killed by.—Aug. 27.

Lightning, Sandy Hook, N.Y., U.S. Ordnance Building destroyed by.—Aug. 15.

Mining, Charleston, W. Va., Frank Morris, John Neil, Jas. D'Eden, Brodie Morris, and others killed by falling slates.—Aug. 22.

Mining, Guaymas, Mexico, eight Mexican miners and two American volunteer rescuers killed by fire early in July, announced.—Aug. 16.

Poisoning, St. Paul, Minn., one hundred picnickers poisoned with ice cream.—Aug. 18.

Railway, Brockville, Ont., collision at, engineer Wm. Emery St. of Albans and conductor Hiram Stoddard of Northfield, killed.—Aug. 30.

Railway, Forest Lawn, N.Y., "Stub" train wrecked by fast express; three killed, many injured.—Aug. 10.

Railway, Knoxville, Tenn., Train on trial trip on Knoxville, Cumberland Gap and Louisville Railroad leaves line and runs down trestle; several killed and others fatally injured.—Aug. 22.

Railway, Lincoln, Neb., passenger train on B. and S.R.R. derailed, 18 badly injured.—Aug. 18.

Railway, Petroleum, W. Va., two trains collide near, four killed, about twenty injured.—Aug. 23.

Railway, Pittsburg, Pa., train leaves track on Western Pennsylvania R. R., killing 3, injuring many.—Aug. 16.

Railway, Russia, Petchougiao, eight carriages smashed, several persons killed.—Aug. 1.

Railway, Shamokin, Pa., freight train on Philadelphia & Reading line breaks through culvert at. Twenty cars wrecked, several injured.—Aug. 22.

Railways, South Bethlehem, Pa., engine dashes into caboose on Lehigh Valley railroad, killing William Garren, and fatally injuring brakeman Mark Christian.—Aug. 9.

Railway tunnel at Cumberland Gap, Ky., knocked in.—Aug. 8.

Railway, Watertown, N. Y., barnum's circus injured by, at, loss about \$40,000.—Aug. 22.

Railway, Weston, Neb., on Union Pacific Ry., freight train drawn by two engines wrecked, engineer Mitchell killed, and switchman Conklin fatally hurt.—Aug. 6.

Railway, West Shore train on Delaware & Hudson Ry. runs off the track; Thomas Coniff, of Albany, killed.—Aug. 2.

Scaffolding, Boston, falls seventy feet, Patrick E. White and Steve Wallace killed.—Aug. 6.

Shooting, El Dorado, Ia., L. F. Wisner, banker, accidentally shot by his son.—Aug. 21.

Shooting, Toronto, Mrs. Sarah Riggan fatally shot by a man on the island, shooting snipe.—Aug. 1.

Storms, Austria, several parts of, visited by hail storms, many killed.—Aug. 21.

AFRICA and Portugal.—"Zaire," Portuguese gunboat, arrives at Quilimane, on June 1, with staff of officers to form an expedition to Lake Nyassa. News received at Washington, from U.S. Consul to Mozambique.—Aug. 6.

East, eleven naval officers sail from Berlin for Zanzibar, as to Capt. Wisman's expedition.—Aug. 5.

Agriculture, Society for promotion of, Toronto, meeting for election of officers.—Aug. 27.

Albery James, dramatic author, death of.—Aug. 16.

Alien contract labor law, Amos L. Allen, immigrant inspector at Newport, Vt., reports to Treasury Department, Washington, as to hardships, likely to follow rigid enforcement of.—Aug. 8.

Ambergis discovered by schooner "Fauny Lewis," off Montserrat.—Aug. 7.

American Electric Light Association, first session of 10th convention in session at Niagara Falls, Ont.—Aug. 7.

American workmen's expedition entertained at dinner in London. Speech by Mr. Lincoln, United States Minister.—Aug. 8.

Atabaska gaol, Philéas Pratte breaks gaol.—Aug. 5.

Astronomy, Vienna, discovery of asteroid of 13th magnitude by Dr. Palsa of Vienna.—Aug. 3.

**AUSTRIA.**—Vienna, The Shah of Persia visits.—Aug. 23.  
The Herzegovinians in revolt against, on Bosnian frontier.—Aug. 23.  
Buda Pestha, Persia, the Shah of, visits.—Aug. 26.

**BEHRING SEA.**—Washington, assistant secretary Wharton interviewed as to seizure of the Black Diamond.—Aug. 21.  
Schooner "Black Diamond," seized by U.S. cutter "Rush," sails into the harbor of Victor a, B.C.—Aug. 3.  
British squadron of Pacific station goes to protect British ships.—Aug. 4.  
Arrest of the "Black Diamond," acting secretary Wharton interviewed thereon, at Washington.—Aug. 5.  
"Black Diamond," Frank He'ert, owner, arrives at Victoria, B.C., and states orders given to captains of sealing vessels.—Aug. 7.  
Report of Captain Shepard, commanding revenue steamer "Rush," regarding the seizure of British sealer "Black Diamond," received at Washington.—Aug. 7.  
Affidavits by captain and seamen of "Black Diamond," giving particulars as to capture.—Aug. 8.  
Fishery seizures, foreign Under-Secretary in Imperial House of Commons interrogated as to negotiations with Washington Government as to.—Aug. 22.  
Seizures in, Senator W. P. Frye expresses his views upon, at Augusta, Me.—Aug. 26.

**Brandy, San Francisco, Cal.,** number of capitalists meet committee of Grape Growers Association, and agree to organize company known as California Brandy Union.—Aug. 3.  
**British Columbia,** Hon. John Robson sworn in as Premier, at Victoria.—Aug. 3.  
**Brodie Steve jumps** the Pawtucket Falls.—Aug. 8.  
**Huckner Hon. James F.,** who served with distinction during the war, death of, at Louisiana, Ky.—Aug. 4.  
**Bulgaria,** reported proclamation of Bulgarian independence.—Aug. 11.  
**Caledonian Association,** Toronto, North American United Convention of, at.—Aug. 22.  
**California Brandy Union,** number of capitalists meet at San Francisco, Cal., and organize the formation of the company.—Aug. 3.  
**Canada Co-Operative Colonization Co.,** Department of Indian affairs at Ottawa receives notice of formation of.—Aug. 7.  
**Cara, Canadian,** not to be taxed, Secretary Windom instructs the collector of Customs at Detroit.—Aug. 4.  
**Catholic Total Abstinence Union of America,** nineteenth annual convention convened at Cleveland, Ohio.—Aug. 7.  
**Chautauque assembly,** opening day of.—Aug. 7.  
**Chaplin Mr.,** appointed President of Board of Agriculture of England.—Aug. 14.  
**Cherokee Legislature,** large majority of Downing party's candidate elected.—Aug. 5.  
**Chicago, Police officer Fryer** of the Desplaines street station shot and killed in street fight.—Aug. 9.  
**Chicago, extensive raid** on gambling houses, 125 persons arrested.—Aug. 17.  
**China, vice-roys of Fukien and Chekiang** issue proclamations against the drowning of female children, advices received.—Aug. 5.  
**Cloud-burst, Columbia, S. C.,** immense damage.—Aug. 17.  
**Columbia Iron Co., Lancaster, Pa.,** increase price per ton for puddling and other wages in proportion.—Aug. 8.  
**Contracts, London, C. P. R. China mail contract** approved by House of Commons.—Aug. 17.  
**Cotton Manufacturing property** of Fall River, Mass., syndicate representing foreign capital makes an offer to purchase.—Aug. 3.  
**Crawford Mr. Robert Wigram,** director of the Bank of England, death of.—Aug. 5.

**CRETE.**—Island in a state of anarchy.—Aug. 1.  
Sultan of Turkey determines to suppress the insurrection.—Aug. 2.  
Sailor belonging to an Italian man-of-war shot by Mussulmans at Canca.—Aug. 3.  
Turks attack and disperse a body of insurgents near Canca.—Aug. 3.  
Egyptian troops occupy Sarnas, 2,000 of Wad-el-Jami's followers submit.—Aug. 5.  
Greek Government sends circular note to the powers, demanding that they take action to restore order in Crete.—Aug. 6.  
Fight at Ileraction between Moslems and Christians, ten killed on each side and many wounded.—Aug. 6.  
Insurgents attack detachment of soldiers, Armenian and Mussulmans volunteers go to the rescue, and sharp fight ensues.—Aug. 6.  
Chakir-Pasha, Turkish ambassador at St Petersburg, stated to have been appointed Governor General.—Aug. 8.  
Porte decides to increase forces in Crete to 30,000 men.—Aug. 20.  
The Porte refuses demands of Cretan commission.—Aug. 23.

**CRIME.**—Abduction, Buffalo, N.Y., Schwinm Lavina S., heiress, abducted by her mother's alleged paramour Chas. A. Boeck.—Aug. 1.

**CRIME.—Continued.**

Abstruders, Boston, Brown G. P., of embarrassed firm of Brown, Stees & Clark, leaves the city.—Aug. 6.  
Abstruders, Kentucky, Tate, defaulting State Treasurer, arrested at Alabama.—Aug. 6.  
Abstruders, Quebec, Leo Minna, arrested at Albany, N. Y.—Aug. 5.  
Abstruders, Quebec, Octave Meunier, arrested at Albany and brought to Montreal.—Aug. 6.  
Defaulters, Kentucky, Tate, absconding State Treasurer, arrested at Alabama.—Aug. 6.  
Defaulter, Philadelphia, Jones William, employee of E. H. Butler & Co., publishers, a well known book connoisseur, shortage \$49,000.—Aug. 15.  
Defalcation, Boston, J. Higgins embezzles \$6,000, dissolves firm of H. W. Tilton & Co.—Aug. 11.  
Forgery, Albany, N.Y., Leo Minna, arrested on a warrant for forgery at Quebec to secure position with insurance company.—Aug. 5.  
Forgeries, Minneapolis, Minn., Collum Frank J., lawyer, forges to the amount of \$267,500 from John S. Haisdell.—Aug. 6.  
Forgery, New York, Allen Pres. E. S., of Forty-Second Street and Grand Street Ferry Railroad, arrested for forging certificates of the railroad's stock for about 700 shares.—Aug. 7.  
Forgeries, Toulouse, France, extensive forgeries of 1,000 franc notes discovered, a number of persons arrested.—Aug. 7.  
Homicide, Ghent, an epileptic kills three and dangerously wounds several other inmates of hospital at.—Aug. 23.  
Robbery, Chippewa Falls, Wisconsin Central passenger train held up and robbed by a single man.—Aug. 8.  
Robbery, Clarence Creek, Ont., Mr. George Barclay shot at, and robbed by two men.—Aug. 5.  
Robbery, Crosswain, Col., the Grande Western train known as "Mudoc" held up by train robbers.—Aug. 6.  
Robbery, Forth Worth and Denver road train held up by six masked men between Cheyenne and Tascumb.—Aug. 4.  
Robbery, Harlem, Mo., 100 masked men enter the St. Paul sleeper attached to rear of Wash Western Express, and go through all the travellers.—Aug. 1.  
Shooting, Colored Oddfellows Lodge, Wilson John shoots George Johnston, Lee Ray, and Alexander Thomas.—Aug. 6.  
Swindlers, New York, Crawford Samuel Oakley alias Dr. A. Bentley exposed in Boston Herald.—Aug. 3.  
Swindling, New York, Eben S. Allen, ex-president of Forty-Second & Grand St. Railway, sentenced to fourteen years for over issue of stock value \$100,000.—Aug. 16.  
Theft, Brockville, Grand Trunk mail bags for Ottawa cut open and registered letters abstracted at.—Aug. 27.  
Cruelty, Stuebenville, Ohio, Striker John, fined and imprisoned for horrible cruelty to his children.—Aug. 1.

**CUSTOMS.**—Canadian cars not to be taxed. Secretary Windom instructs the collector of Customs at Detroit.—Aug. 4.  
Canadian, Chatham, Ont., steamer "W. F. McCrene," seized for landing goods without reporting outwards or inwards.—Aug. 2.  
Canadian, Hamilton, Ont., seizure of 1,325 bags and 75 barrels of Muscovado sugar.—Aug. 2.  
Canadian shoeks, decision of Treasury department, Washington, on.—Aug. 2.  
Canadian, Saint St. Marie, Ferry steamer "J. L. Beckwith," seized by Canadian officials for coasting.—Aug. 1.  
Canada, refuse permission to directors of Union Agricultural Society of Eastern Townships to bring in cattle, sheep and swine for exhibition.—Aug. 9.  
Dakota, Sioux reservation, requisite number of signatures for opening of secured.—Aug. 6.  
Dakota (North), Bismarck named as capital.—Aug. 17.

**DEATHS.**—Buckner Hon. James F., who served with distinction during the war, at Louisville, Ky.—Aug. 4.  
Albery James, dramatic author.—Aug. 16.  
Andrews Judge George, Tenn., killed in railway accident at Knoxville.—Aug. 22.  
Jordaux, Archbishop of.—Aug. 15.  
Biswell George, Morse, late judge of Northumberland and Durham counties, at Cobourg.—Aug. 27.  
Cantoret Madame la Marcheline, at Paris.—Aug. 6.  
Crawford Mr. Robert Wigram, director of the Bank of England.—Aug. 5.  
Dupond General Henry, gunpowder manufacturer of Wilmington, Del.—Aug. 8.  
Eddy Thoma, contractor, at Toronto.—Aug. 27.  
Ewart Sir William, M.P. for Northern division of Belfast.—Aug. 2.  
Falarban, Chevalier Antoine, Canadian painter, at Florence, by drowning, announced.—Aug. 16.

1  
1  
1  
1  
1  
M  
M  
M  
M  
P  
P  
R  
R  
W  
Denun  
DIPLO  
Divorc  
Duel, t  
Dupond  
Earthq  
Earthq  
Earthq  
ECCLES  
Bor  
Haf  
Mon  
Sia  
Monte  
Ott  
Shoe  
de  
Siam  
Mie  
Victo  
Mil  
West  
15.  
Editorial  
27.  
EGYPT  
rou  
Bak  
tain  
Gren  
wh  
Took  
wi  
Au  
ELECTI  
can  
Belfa  
sion  
Fran  
Leg  
Kentu  
Aug  
Virgi  
for  
ven  
Electric  
con  
Encyclo  
Seri  
Englewo  
mur

## DEATHS.—Continued.

Ferguson Charles L., of law firm of Ferguson, Ferguson & O'Brien, at Toronto.—Aug. 3.

Haban Rev. Father, death of at Toronto.—Aug. 9.

Hammill Rev. Father, pioneer priest of Missouri, at Shockeyford, Mo.—Aug. 4.

Hutton Mr. James, wholesale merchant, at Montreal.—Aug. 23.

Labelle Captain J. H., M.P. for Hibernian county.—Aug. 3.

Ladlaw George, railway promoter, on his farm at Hulsam Lake.—Aug. 6.

MacPherson Henry, Judge of the County of Gray, dies at Owen Sound.—Aug. 4.

McConnell Rev. F., Baptist pioneer missionary, at Ottawa.—Aug. 2.

Massala Cardinal William, at Naples.—Aug. 6.

Montreal, Vicar General Rev. Father Miller dies.—Aug. 13.

Philippovich General, the conqueror of Bosnia.—Aug. 5.

Pyat Felix French writer and dramatist, death of.—Aug. 4.

Richardson John A., at Amerley near London.—Aug. 4.

Slater George, well-known journalist, at New York.—Aug. 15.

Watkins Charles A., theatrical manager, at Oneonta, N.Y.—Aug. 22.

Denmark, Copenhagen, The Cear and Usarina visit.—Aug. 27.

**DIPLOMATIC**—Russia and Japan, treaty between signed at Tokio.—Aug. 8.

Divore, New York, case of Flack vs. Flack annulled.—Aug. 13.

Duel, Cottonport, Avoyella's, La., Charlie Armour and his father-in-law Henry Ducate fight, the former severely and the latter mortally injured.—Aug. 5.

Dupond General Henry, gunpowder manufacturer, death of, at Wilmington, Del.—Aug. 8.

Earthquake, Etolion, Greece, heavy shocks of, do damage at.—Aug. 26.

Earthquake, Herzegovina, severe shocks felt.—Aug. 17.

Earthquake, Khensouk, Russia, 120 people burned alive at.—Aug. 26.

Earthquake, Los Angeles, Cal., severe shock of, at.—Aug. 28.

**ECCLIASTICAL**—Ottawa, Rev. F. McConnell, Baptist pioneer minister.—Aug. 2.

Bordeaux, death of Archbishop of.—Aug. 15.

Halifax, Presbytery of Halifax, Presbyterians elect.—Aug. 21.

Montreal, Douglas Church, foundation stone of, laid by Sir Donald Smith, K. C. M. G., M.P.—Aug. 31.

Montreal, petition of Louis Aronson et al. for order to establish Jewish congregation in, granted by Judge Pagnuelo at.—Aug. 26.

Ottawa, Reformed Episcopal Synod elect their officers.—Aug. 17.

Shockeyford, Mo., Rev. Father Hammill, pioneer priest of Missouri death of.—Aug. 4.

Siam, King of, grants use of royal palace to American Presbyterian Mission.—Aug. 28.

Victoria, B. C., Davie Hon. Theo., Attorney-General, elected over Dr Milne, majority 111.—Aug. 21.

Westphalia, Archbishop of Cologne stoned by anti-Catholics.—Aug. 15.

Editorial National Association, Detroit, annual convention of, at.—Aug. 27.

**EGYPT**—Gen. Grenfell engages the Dervishes near Toski and completely routes them. Wad-el-Jumi the Dervish leader, killed.—Aug. 3.

Baker Sir Samuel, writes to London on defeat of Wad-el-Jumi, maintaining the necessity of occupying Dongola and Berber.—Aug. 5.

Grenfell Gen., returns to Cairo, Cavalry in pursuit of the one Emir who survived the battle.—Aug. 6.

Toski, documents found in the abandoned camp of Wad-el-Jumi which prove widespread Egyptian conspiracy, news from Cairo.—Aug. 6.

**ELECTIONS**, Cherokee legislature, large majority of Downing party's, candidates elected.—Aug. 5.

Belfast, Ireland, Sir W. Harland, Conservatives, elected for North Division of.—Aug. 12.

France, second ballots for members of Councils General taken, M. Laguerre, Boulanger leader, elected at La Rochelle.—Aug. 4.

Kentucky, State treasurer, Stephen H. Sharp, of Lexington, elected.—Aug. 6.

Virginia, Geo. Wm. Mahone and Col. Campbell C. Slemp nominated for Governor and Lieut.-Governor respectively by Republican convention.—Aug. 23.

Electricity, American Electric Light Association, first session of tenth convention in session at Niagara Falls, Ont.—Aug. 7.

Encyclopedia Britannica, Edinburgh publishers take action against C. Scribner of New York for publishing cheap reprint of.—Aug. 13.

Englewood, Ill., town put under military discipline, in consequence of murderous assaults, highway robberies and burglaries.—Aug. 4.

Execution, gallotine, St. Pierre, Miqueloo, Noel, a French fisherman, executed by, at.—Aug. 24.

Execution, New York, Packerham, Nolan, Lewis and Carolin hanged at.—Aug. 23.

Executive Health Officers' Association, Brockville, Ont., meeting of, at, for appointment of officers.—Aug. 21.

Ewart Sir William, M.P. for Northern Division of Belfast, death of.—Aug. 2.

**FAILURES**, Boston, W. F. Johnson & Co., leather dealers.—Aug. 1.

Boston, American Dressed Beef Co. of.—Aug. 10.

Boston, MacIntosh John S., assigns at; liabilities \$100,000.—Aug. 27.

Brockton, N.Y., Vandemark T. & W., yarn and woolen goods manufacturers, assign; liabilities \$23,000.—Aug. 23.

Belham, Mass., Steag Edwards and Clark Amasa (Brown Steese and Clark), wool dealers, file petition on bankruptcy.—Aug. 21.

Dundas and Woodstock, Ill., Hall A. F., merchant, liabilities \$100,000.—Aug. 15.

Hamilton, Ont., Kay Electric Light Co. assigns.—Aug. 7.

Indianapolis, Decatur and Western railroad placed in the hands of a receiver.—Aug. 9.

Kansas City, Kingston, Peake & Co., dry goods, liabilities \$90,000.—Aug. 15.

Philadelphia, Crowther David, & Son, yarn spinners.—Aug. 10.

Providence, R. I., Waunagan Cotton Goods mill, Tara E.P., treasurer, suspend payment. Liabilities estimated at \$1,000,000.—Aug. 21.

Pouling, Pa., Keystone Furnace Company assigns. Liabilities \$250,000.—Aug. 21.

St. John, N.B., Simmons & Burpee, large bridge builders and mill owners, assign.—Aug. 23.

Toronto, Hass Bros., wholesale furniture manufacturers, assign.—Aug. 8.

Fielding Albert, captain of dredge "Sir Hector L'Amirault" found dead on railway track of Louise embankment, Quebec, foul play suspected.—Aug. 8.

**FISHERIES**, arrest of the "Black Diamond," acting secretary Wharton interviewed thereon at Washington.—Aug. 5.

Cedar Keys, Fla., Spanish cutter "Montezuma" seized by revenue cutter "M. Lane"—Aug. 2.

Fleming Mr. Sanford, elected president of Ottawa Art Association.—Aug. 2.

Floods, Johnston, bodies of ten more victims recovered.—Aug. 9.

Floyd County, Ga., prohibition defeated by majority of 600.—Aug. 6.

Flux, Charleston, W. Va., virulent epidemic of, prevailing at, over 50 died.—Aug. 23.

Fever, Texas, raging among cattle, hundreds of, die daily.—Aug. 28.

Foresters, Order of, the High Court assembled at Bourne-mouth grants a demand of Loyal Courts of America to establish subsidiary High Court in that country.—Aug. 7.

Foresters, Minneapolis, subsidiary High Court of A. O. F. votes to sever connection with High Court of England, on account of latter insisting upon admission of colored men to the Order.—Aug. 15.

**FRANCE**, Angouleme, riots at, Paris Appeal Court confirms sentences imposed upon M. De Roulede and M. Laguerre.—Aug. 7.

Boulanger issues a declaration that accusations against him are infamous slanders.—Aug. 6.

Boulanger Gen., trial of, begins before High Court of Senate.—Aug. 8.

Boulanger, Senate Court finds Boulanger guilty of conspiracy.—Aug. 13.

Boulanger defended by General du Brial at Bonapartist banquet.—Aug. 16.

Boulanger presented with address by 500 people at London.—Aug. 18.

Boulanger Gen., suspended of Legion of Honor.—Aug. 24.

Bujie Capt., formerly member of Boulanger's staff, arrested in Paris on charge of being German spy.—Aug. 7.

Deserters, seven thousand French deserters leave Geneva for France.—Aug. 11.

Paris, Comte Carnot, French statesman who died in 1823, remains received to be placed in the Pantheon.—Aug. 2.

Paris, remains of Garnot, Marceau, d'Auvergne and Baudin deposited in the Pantheon.—Aug. 4.

Paris, Count Robert de Maistre, death of.—Aug. 6.

Paris, man named Banninger sentenced for selling diplomatic documents to German agents while an employee of Danish Ministry in Paris.—Aug. 6.

Paris, American and English deputations wait on President Carnot.—Aug. 11.

Paris, Comte de Paris publishes the preface of the history of his father's life.—Aug. 13.

## FRANCE.—Continued.

Paris, Count Dillon and Henri Rocheford, accomplices of Boulanger, found guilty of conspiracy against State.—Aug. 14.

Paris, Scripps American workmen place wreath on statue of Republic.—Aug. 14.

Paris, M. Carnot banquets 15,000 people.—Aug. 18.

Paris, M. Thiers, Boulangerist, Deputy, arrested at meeting for interfering with police.—Aug. 27.

Second ballots for members of Councils General taken. M. Laguerre Boulangerist leader, elected at La Rochelle.—Aug. 4.

Froude, the historian, writes on Home Rule.—Aug. 1.

Gas, Port Colborne, Ont., big flow of natural gas near, estimated at 1,250,000 feet per day.—Aug. 26.

Gas, Toledo, Ohio, city obtains land at Van Buren, and strikes a yield of twenty million feet of gas per day.—Aug. 7.

GERMANY, Emperor William of, arrives in the Downs.—Aug. 1.

Berlin, Emperor Francis Joseph visits.—Aug. 12.

Socialism, Berlin police suppressing meetings convened to hear reports from delegates to Paris labor congress.—Aug. 4.

Strasburg, Emperor William visits.—Aug. 22.

Naval frauds, privy councillor Kruger arrested in Berlin.—Aug. 5.

Gold, Arrow Hoek, Mo., gold discovered in paying quantities.—Aug. 1.

Goldwin Smith interviewed at Winnipeg on French School question in Toronto.—Aug. 8.

Haban Rev. Father James, senior priest in Diocese of Toronto, death of.—Aug. 9.

Halifax, N. S., carnival, opening of.—Aug. 5.

Halifax, N. S., Military and Naval demonstration.—Aug. 6.

Hamilton, Ont., summer Carnival opens.—Aug. 19.

Harrison President, in speech at Bath, Me., promises to promote rebuilding of American mercantile marine.—Aug. 15.

HAYTI, Cold-blooded murders committed by order of rival commanders, despatch to New York *Times* received dated Port-au-Prince July 28th.—Aug. 6.

Hippolyte and Jean Jumeau on July 28th attack Port-au-Prince but are routed, advice received by Haytian consul at New York.—Aug. 5.

Saletron, Hippolyte lands 1000 men, report brought by steamship "George W. Clyde" to New York.—Aug. 8.

Steamer "Ozama" arrives at New York and reports that on July 14th General Girardi, Hippolyte's commander, took Port Toussaint l'ouverture, but in endeavoring to get into Port-au-Prince the troops ambuscaded.—Aug. 2.

Healy Robert, old and well known citizen, and ex-priest, dies at Anamosa, Ia.—Aug. 9.

Honolulu, insurrection reported by "SS. Alameda," at San Francisco.—Aug. 10.

Horses, Ontario Government issues commission to Dr. Bryce to proceed to Kent and Lambton counties, and take evidence bearing upon outbreak of contagious disease among horses.—Aug. 6.

Hungary, Buda Pesth, summer manoeuvres, many soldiers of regiment of Hussars left unconscious upon the field from overwork.—Aug. 5.

Ice, mine discovered in Idaho.—Aug. 20.

Idaho, Boise City, constitutional committee closes.—Aug. 6.

Immigrants, England, Committee appointed by Parliament make a report.—Aug. 9.

Immigrants, New York, passengers by steamship "England" lodge complaint as to their treatment, with secretary Jackson of emigration board.—Aug. 2.

IMPERIAL PARLIAMENT.—Commons, Dr. Tanner's sentence under Criminals Act, Mr. Sexton moves adjournment to consider same.—Aug. 1.

Commons, Royal grants bill passed.—Aug. 5.

Commons, anti-slave congress in Brussels, Sir James Ferguson gives information thereon.—Aug. 5.

Commons, Dongola and Berber, Mr. Smith says England has no intention of occupying.—Aug. 6.

Commons, Irish estimates, Mr. Harrington attempts to assault Mr. Balfour, but is restrained.—Aug. 8.

Commons, Matthews, Home Secretary, denies that Parnell's letters tampered with.—Aug. 15.

Commons, Irish Secretary's salary, motion of Mr. Sexton to disallow rejected.—Aug. 21.

Commons, Ireland, debate on Irish prisons.—Aug. 23.

Lords, Secretary of State for India announces resignation of ruler of Cashmere, and formation of native council.—Aug. 27.

Lords, Royal Grants bill discussed, Lord Salisbury denies the existence of any agreement with the Queen.—Aug. 6.

Royal Grants bill passes the Committee stage.—Aug. 2.

Titles Bill withdrawn.—Aug. 16.

Ireland, Irish estimates. Law charges voted after last debate.—Aug. 22.

Inceudiarism, Danbury, Conn., three more cases of, occur.—Aug. 3.

Inceudiarism, Winnipeg, George P. Vancea, a lawyer and leading citizen arrested for setting fire to building occupied by Mrs. Young.—Aug. 5.

Ice trust, New York, collapse of.—Aug. 3.

India, Cashmere, ruler of resigns, and native council formed.—Aug. 27.

Indians, Northwestern Indian Commission gets the consent of the Gull Lakers, a band of Chippewa dwelling about the original seat of the Chippewa Government at Gull Lake.—Aug. 7.

Indians, Standing Rock, Dak., the final council held with all the chiefs but Gall and Running Antelope.—Aug. 4.

Indians, Standing Rock Agency, Dak., final council held at.—Aug. 6.

Iowa State Republican Convention nominates Hutchison for Governor.—Aug. 15.

IRELAND, Arthurstown, Wexford, charge preferred by the Government against Canon Doyle and others, of holding illegal meetings, abandoned, as witnesses refuse to be sworn.—Aug. 5.

Clonakelty, Wm. O'Brien and James Gilhooly put on trial at, for holding proclaimed National meeting.—Aug. 23.

Clonakelty, Wm. O'Brien and J. Gilhooly, M.P.'s, sentenced respectively to two months and six weeks imprisonment for holding proclaimed meetings.—Aug. 26.

Dr. Tanner, sentence on, Mr. Sexton moves adjournment of House of Commons to consider same.—Aug. 1.

Home Rule, Froude, the historian, writes on.—Aug. 1.

O'Connor John and Condon T. J., M.P.'s for Tipperary, released from prison.—Aug. 31.

Knock, 40,000 persons visit the shrine.—Aug. 16.

Skibbereen, linen manufacturers established at.—Aug. 24.

Irish, Sunday closing bill, Cardinal Manning expresses his approval thereof.—Aug. 4.

Iron workers, Pottsville, Pa., Iron and Steel Company, wages of employees advanced 12 per cent.—Aug. 3.

ITALY, capture of Mrs. Geo. Pendleton Bowler of Cincinnati, by bandits, news received via Bar Harbor.—Aug. 5.

Parliament, sudden prorogation of.—Aug. 2.

Japan, floods caused by overflowing of river Chiku Gu in Fu Kuo Ken, particulars of loss given in *Japan Gazette*.—Aug. 8.

Japan, riot between two factions of Chinese coolies at Sang Kong, 900 rioters captured.—Aug. 5.

Jesuits' Estates Bill, Quebec, the Governor General receives the deputations, and refuses to interfere with the act.—Aug. 2.

Jutland, serious epidemic of typhoid fever.—Aug. 17.

Kentucky, State treasurer, election of, Stephen H. Sharp, of Lexington elected.—Aug. 6.

Kilrain Jake, arrested at Ocean View, Va.—Aug. 5.

Labelle Captain J. B., M.P. for Richelieu County, death of.—Aug. 3.

Labor Day.—Aug. 31.

LEGAL, Cobourg, Conmee and McLennan vs. Canadian Pacific Railway Judge Armour gives verdict in favor of Plaintiffs.—Aug. 1.

Owen Sound, Ont., MacPherson Henry, judge of County of Grey death of.—Aug. 4.

Quebec, "Polynesian," "Cynthia" collision, trial commences in Vice-Admiralty Court.—Aug. 20.

Toronto, death of Charles L. Ferguson, of the law firm of Ferguson, Ferguson & O'Brien, at Toronto.—Aug. 3.

Lynching, Orange, Tex., J. Brooks, colored, for rape.—Aug. 13.

Majara Hydraulic Electric Company meets at Alexandria, Va., to receive reports regarding plans for utilizing water power at Niagara Falls.—Aug. 2.

MANITOBA, separate schools, Clearwater, Liberal picnic, Hon. Mr. Smart, member of local government, speaks on.—Aug. 2.

Dual Language question, Hon. Mr. Prendergast interviewed thereon, at Winnipeg.—Aug. 7.

Hon. J. Pendergast, Provincial Secretary, resigns.—Aug. 14.

MARRIAGES, Anastasia Princess, third daughter of Prince of Montenegro, betrothed to Duke George of Leuchtenberg.—Aug. 7.

Blackwood Lady Ellen, engaged to be married to Mr. Ferguson, M.P. for Leith, Scotland.—Aug. 1.

File Duke of, declines to permit his wife to accept share of Parliamentary grant.—Aug. 13.

Russia, Princess Miliza, daughter of Prince Nicholas of Montenegro to Grand Duke Peter, nephew of the Czar, solemnized at St. Petersburg.—Aug. 7.

Maybrick trial, Liverpool, medical experts give evidence.—Aug. 2.

Maybrick Mrs., sentenced to death at Liverpool.—Aug. 7.

cur.—Aug. 3.  
and leading citizen  
by Mrs. Young.—

formed.—Aug. 27.  
consent of the Gull  
be the original seat of  
. 7.  
with all the chiefs  
ld at.—Aug. 6.  
du for Governor.—

by the Government  
al meetings, aban-  
out on trial at, for  
sentenced respect-  
for holding prop-  
ment of House of  
. 1.  
rately, released from  
Aug. 24.  
is approval thereof.  
wages of employes  
cinnati, by bandits,  
Go in Fu Kuo Ka  
—Aug. 8.  
at Sang Kong, 900  
receives the deputa-  
. 2.  
rhp. of Lexington  
h of.—Aug. 3.  
n Pacific Railway  
—Aug. 1.  
County of Grey  
al commences in  
firm of Ferguson,  
Aug. 13.  
ia, Va., to receive  
at Niagara Falls.  
e, Hon. Mr. Smart,  
rviewed thereon,  
—Aug. 14.  
—ance of Montene-  
—Aug. 7.  
r. Ferguson, M.P.  
are of Parliamen-  
s of Montenegro  
luminized at St.  
—Aug. 2.

**MEDICAL,** Elixir of Life, Washington, D. C., Dr. W. A. Hammond experiments with it, wonderful results attained.—Aug. 1.  
Cincinnati, Ohio, Dr. Robert Longfellow conducts successful experiments with Dr. Brown-Sequard's Elixir of Life.—Aug. 9.  
Chicago, experiments with Elixir of Life, startling effects.—Aug. 11.  
St. Louis, Dr. Shaw, in examining Brown-Sequard Elixir, discovers existence of bacteria.—Aug. 14.  
Brown-Sequard Elixir, Birmingham, Ala., Dr. Lechstein fatally experiments with.—Aug. 15.  
Montreal, Dr. Brodeur makes experiments with Brown-Sequard Elixir.—Aug. 19.  
Shamokin, Pa., experiment with Life Elixir causes death of ten persons.—Aug. 16.  
Merchants' Convention, Hamilton, third session at.—Aug. 21.  
Mexico, San Juan Wiloa, prisoners confined at revolt, the troops shoot twenty.—Aug. 7.

**MILITARY,** Pauda, Pesth, summer manoeuvres, many soldiers of regiment of Hussars left unconscious upon the field from overwork.—Aug. 5.  
Berlin, Emperor William and Emperor of Austria witness smokeless powder sham-fight.—Aug. 14.  
Canada, Pope Lt.-Col. F. M., appointed to brigade majorship of Eastern Townships district.—Aug. 1.  
England, Emperor William reviews 26,000 troops at Aldershot.—Aug. 7.  
Halifax, N.S., successful demonstration.—Aug. 6.  
Kingston, the Dominion Government offers \$35,000 towards construction of Drill Hall at.—Aug. 23.  
Montreal, P. Q., R. A. hold twenty-first annual prize meeting.—Aug. 13.  
Montreal, Six Fusiliers R. A. hold twenty-fifth annual meeting.—Aug. 17.  
Ontario, Rifles Association, election of officers at Walker match, shooting for it.—Aug. 27.  
Ottawa, Dominion R. A. alter Snider rifle sight regulations.—Aug. 19.  
Philippovich General, the conqueror of Bosnia, death of.—Aug. 5.  
Serbia, War Ministry orders all three of the military classes of Serbia to muster.—Aug. 2.  
Stanley Hon. E., gazetted A. D. C. to the Governor General.—Aug. 24.  
Turkish reserves, eighty thousand called out.—Aug. 2.  
United States, War Office decides to supply army with smokeless powder.—Aug. 23.  
Millers, Peterboro, O., meeting of millers discuss the working of the duties on flour and wheat.—Aug. 6.  
Miners, Durham miners accept ten per cent. advance offered by the owners.—Aug. 2.  
Mining, Asimbolia, N. W. T., Stair Coal Mine & Manufacturing Company (limited) incorporated with capital of \$500,000.—Aug. 23.  
Mining, Nova Scotia, 13,626 ounces of gold estimated to have been mined at, in six months preceding.—Aug. 28.  
Mining, Pratt mines of Tennessee Coal Iron and Railway Co., shaft No. 1 on fire.—Aug. 2.  
Missouri, House of Delegates passes the Scott Elevated Railroad Bill.—Aug. 3.  
Missions, Washington, D. C., report forwarded that American missions in China and Corea are fruitless.—Aug. 11.

**MURDERS,** Brodiek Bay, Scotland, Rose Edwin, an English tourist, found murdered on the Goatfell.—Aug. 3.  
Brooklyn, Luca C. W., stabbed by one of three burglars, Benson, Quinlan and McElwain.—Aug. 21.  
Chicago, Saell Mrs. Hourietta, offers reward of \$50,000 for arrest and detention of Tascott William B., supposed murderer of her husband.—Aug. 1.  
Chicago, Cronin, Burke pleads not guilty of murder.—Aug. 9.  
Chicago, Cronin trial, Burke identified as lessee of Carlston Cottage.—Aug. 2.  
Chicago, Cronin, Burke taken from Winnipeg to Chicago under a very strong escort.—Aug. 3.  
Chicago, Cronin Dr., trial of prisoners on charge of, opened at.—Aug. 26.  
Chicago, Cronin Dr., Gus. Klabers, a witness in against prisoners accused of, nearly assassinated.—Aug. 27.  
Chicago, Ills., Col. Dunnean shoots Ed. Bennett at colored barbers' picnic, Island Park, and is killed by the mob.—Aug. 5.  
Cleveland, Ohio, O'Brig Charles, while creeping under circus tent struck by showman and killed.—Aug. 8.  
Corvallis, Mont., dead bodies of Ollie Jones, his wife and two other persons found shot in the back.—Aug. 7.  
Fergus, Ont., Haley Patrick, who stabbed Miss Ellis of Garafraza, arrested.—Aug. 2.

**MURDERS.—Continued.**

Johnstown, Pa., McCormack James, shot and killed by Harry Moyer.—Aug. 5.  
Lathrop, Cal., Judge Terry shot by Deputy Marshall Nagle.—Aug. 14  
Lathrop, Cal., Field Judge, warrant issued against for killing Judge Terry.—Aug. 15.  
Liverpool, Maybrick Mrs., sentenced to death.—Aug. 7.  
Liverpool, Maybrick James, will published.—Aug. 11.  
Liverpool, Maybrick death sentence fixed to be carried out on Aug. 26.—Aug. 12.  
Liverpool, Maybrick, remission of Maybrick sentence petitioned.—Aug. 13.  
Liverpool, Maybrick, fifty-two M.P.'s sign memorial requesting commutation of Maybrick sentence.—Aug. 15.  
Liverpool, Maybrick Mrs. Florence, sentence of death commuted to penal servitude for life.—Aug. 22.  
Louisville, Ky., Jim Turner, shot dead by one of the Howards in the Court House.—Aug. 5.  
Lumens, Mo., Howell J. S., murderer of Mrs. Hall and three children sentenced to be hanged.—Aug. 6.  
McGann John, a teamster, shot and killed by his stepson, James Dolan.—Aug. 6.  
McDowell County, W. Va., widow and two daughters criminally assaulted and killed.—Aug. 9.  
Megantic, Morrison Donald, preliminary examination at Sherbrooke.—Aug. 9.  
Peun, three men murdered in coal mines.—Aug. 17.  
Toronto, Hicks James, dies from poisoning, Charles Cole and Arthur Hicks arrested on suspicion.—Aug. 7.  
Toronto, Hicks James, his sister Mrs. Sarah White arrested for.—Aug. 8.  
Musical, Ottawa, Canadian College of Music established.—Aug. 17.

**NAVAL.**—British, inspection of fleet at Spithead by Emperor of Germany.—Aug. 3.  
British Squadron of Pacific station goes to protect British ships in Behring Sea.—Aug. 4.  
British, great review at Portsmouth.—Aug. 5.  
British, "Black Prince" and "Invincible" come into collision off Spithead, and both much damaged.—Aug. 6.  
Germany, Capt. Wissmann's expedition, eleven naval officers sail from Berlin for Zanzibar to join.—Aug. 5.  
Germany, frauds, Privy Councillor Kraeger arrested in Berlin.—Aug. 5.  
Halifax, N.S., successful demonstration.—Aug. 6.  
H. M. S.S. "Touradine" and "Hylades" at Montreal.—Aug. 21.  
Quebec, H. M. S. S. "Belleroophon" and "Hylades" arrive at city.—Aug. 19.  
St. Petersburg, Russian Gov. order construction of ten large iron-clads.—Aug. 19.  
New Brunswick, N.J., Raritan river overflows its banks and stops the canal and all factories.—Aug. 1  
Nicaragua Malt Steam Navigation and Trading Company, Denver, incorporated at.—Aug. 22.

Nihilists, Russia, eighty arrested at Khar Koff.—Aug. 5.  
Oh, Terre Haute, Md., second fine well struck.—Aug. 1.  
Pacific Postal Telegraph Company, annual meeting of, held at New York.—Aug. 7.  
Panama Canal Company, M. Brunet the liquidator informs the shareholders that a financial syndicate has taken the whole amount of the new lottery bonds.—Aug. 1.  
Pearls, Albany, Wis., pearls discovered in clam shells taken from sugar.—Aug. 8.  
Persia, Shah leaves Paris.—Aug. 9.  
Persian, Bagdad, cholera report raging at, sud at Bussorah.—Aug. 21.  
Philadelphia Universal Peace Union petition people of U.S. to adopt a national relief fund.—Aug. 19.  
Photographic Association, Toronto, Canadian, sixth annual convention of, at.—Aug. 21.  
Plymouth, Mass., national monument in honor of the Pilgrim Fathers unveiled.—Aug. 1.  
Portugal and Africa, "Zaive" Portuguese gunboat arrives at Quillimane on June 4, with staff of officers to form an expedition to Lake Nyassa, news received at Washington from U. S. Consul to Mozambique.—Aug. 6.  
Postal, great reductions on parcel post rates in Canada addressed to United States and Newfoundland, to commence Sept. 1st, notified.—Aug. 23.  
Pottsville, Pa., Iron and Steel Company, wages of employes advanced 12 per cent.—Aug. 3

- Prince of Wales receives friendly anonymous letter, £10,000 enclosed.—Aug. 19.
- Prohibition, Lloyd county, Ga., defeated by majority of 600.—Aug. 6.
- Pugilism, Purvis, Miss., J. L. Sullivan sentenced to 12 months imprisonment.—Aug. 17.
- Fyat Felix, French writer and dramatist, death of.—Aug. 4.
- QUEBEC, Lord Stanley entertains Sir Somers Vane and officers of Citadel.—Aug. 10.
- District Magistrates Court Act disallowed.—Aug. 12.
- Queen Victoria presents Bismarck with portrait of herself.—Aug. 20.
- RAILWAYS.—Brockville, Westport and Sault Ste. Marie Railway, McMichael Mr. C. B., solicitor of a syndicate of American capitalists, attends at Ottawa, and makes a thorough inspection of the road.—Aug. 7.
- C.A.R.R. notify Chaudiere mill owners of reduction of 25c per 1,000 ft. of lumber, to New York.—Aug. 17.
- C. B. & N. R.R. cut rates to 85c, to New York.—Aug. 17.
- Canadian Pacific, Souris branch grading contract of line to Egan and Dennison, south of Plum Creek, awarded.—Aug. 21.
- Canadian Pacific v. Conmee and McLennan, Judge Armour gives verdict in favor of plaintiffs.—Aug. 1.
- Cape May, N.J., general passenger agents of U. S. Railroads decide to reduce summer excursion rates from South to East and North.—Aug. 14.
- Chicago, Ills., Freight Committee of C. T. A. declare rise in iron and steel rates after Sept. 1st.—Aug. 15.
- Chicago and Alton tariff of live stock from points in Kansas to Chicago, Chairman Walker, of Interstate Commerce Railway Association, decides it illegal.—Aug. 1.
- Chicago, Milwaukee, and St. Paul Road gives notice of its intention to reduce the rate on cattle  $\frac{3}{4}$  cents per 100 pounds from Kansas city to Chicago.—Aug. 8.
- Chicago, Milwaukee & St. Paul line adopt the proportional tariff in force on the Burlington & Northern.—Aug. 20.
- Chicago, Northwestern revuls at, withdraw proportional tariff established between Chicago and St. Paul.—Aug. 23.
- China, syndicate begin to lay rails from Hankow to Peking.—Aug. 15.
- Indianapolis, Decatur and Western railroad placed in the hands of a receiver.—Aug. 9.
- New York, W. J. Mortimer and others vs. Manhattan Elevated Railroad, appeal of defendants dismissed.—Aug. 20.
- Northern Pacific Railroad, directors determine to place mortgage for \$100,000,000.—Aug. 21.
- Ottawa and Gatineau R.R. commenced.—Aug. 20.
- Pittsburg, C.T.A., announce advance in iron freight rates between New York and Chicago.—Aug. 20.
- Regina, laying of the Regina and Long Lake R. R. commenced.—Aug. 17.
- Trans-Caspian railroad, Council of State votes additional \$6,000,000, and orders work to be pushed on.—Aug. 1.
- Missouri Pacific notifies chairman Midgley that it proposes to adopt earload rates on live stock from Kansas City to St. Louis.—Aug. 8.
- Rates, New York, meeting of representatives of New England Trunk Lines Association and Southern Association decides that on and after September 1st, passenger rates from all points in New England to all points in South and South East shall be uniform.—Aug. 6.
- Scott elevated railroad passes the Missouri House of Delegates.—Aug. 3.
- Trans-Continental difficulties, terms of settlement published.—Aug. 3.
- Vandrenil & Prescott Railway initiates proceedings for expropriation of lands between Rigand & Vaadrenil at estimated cost of \$500,000.—Aug. 23.
- Winnipeg transfer road connecting Northern Pacific and Manitoba with Canadian Pacific Railway completed.—Aug. 5.
- Woolwich, Ont., bonus of \$25,000 granted to Waterloo Junction Railroad by township of.—Aug. 27.
- Richardson John A., death of, at Amerey near London.—Aug. 4.
- Richmond, Tex., in political factional fight, several persons killed.—Aug. 17.
- Rimonski, P.Q., corner stone of new hospital laid.—Aug. 4.
- Riot, fatal, Petersburg, Pa., between Italian and Negro laborers.—Aug. 15.
- RUNSLA.—Trans-Caspian railroad, Council of State votes additional \$6,000,000, and work being pushed on.—Aug. 1.
- Credit bank of Russian Government forecloses 2,000 estates.—Aug. 20.
- Erzeroom, advices from, say unusual activity prevails among Russians on the frontier, between Erivan and Tiflis, 8,000 men quartered.—Aug. 1.
- Count Tolstol's reform projects approved by the Czar in a *Ukase*.—Aug. 3.
- Nihilists, eighty arrested at Khar Koff.—Aug. 5.
- St. Lawrence river, Hydrographer Wharton makes his report at Ottawa.—Aug. 5.
- Ste. Croix, Gaiticus De Ste, of London, Eng., arrives at Duluth, Minn., to carry out scheme to bring American wheat growers and elevator men together with British millers.—Aug. 6.
- Samos, German gunboat goes to the Marshall Islands to bring back King Malietoa, advices received at San Francisco.—Aug. 4.
- Scientists, American Association of, Toronto, election of members of, at.—Aug. 27.
- Sea serpent killed, Panama letter to New York says Capt. W. F. Smith of barque "Neuburg" when off Cape Berkeley, Galapagos Islands, killed a sea serpent.—Aug. 1.
- SERVIA.—War ministry orders all three of the military classes to muster.—Aug. 2.
- Shah leaves Paris for Baden.—Aug. 15.
- SHIPPING.—Belle Isle, steamship "Montreal" of the Dominion line from Montreal to Liverpool totally wrecked.—Aug. 4, reported 8.
- Bie, P.Q., "Miramichi" steamship strikes on a rock and is got off with considerable damage.—Aug. 1.
- Brig "Lilliau" on voyage from Halifax to Glace Bay, C.B., pick up two dories containing six fishermen belonging to Lunenburg schooner "C. A. Chisholm".—Aug. 7.
- Cedar Keys, Fla., Spanish cutter "Montezuma" seized by revenue cutter "M. Lane".—Aug. 2.
- Chatham, Ont., steamer "W. F. McCrae" seized for landing goods without reporting outwards or inwards.—Aug. 2.
- Cincinnati, Ohio, collision between steamer "Commonwealth" and lumber steamer "Young Duck." "Commonwealth" fired, \$30,000 loss.—Aug. 26.
- Collision, Sault Ste Marie, Mich., S.S. "Alberta" runs into "Oregon".—Aug. 12.
- Hamilton, Ont., Propeller "Celtic" bound for the lake cuts the yacht "Volunteer" in two, no one injured.—Aug. 8.
- Hog Island, Palace steamer "St. Lawrence" of Thousand Islands Steamboat Company wrecked.—Aug. 1.
- New York, emigrants by steamship "England" lodge complaint as to their treatment, with Secretary Jackson of emigration board.—Aug. 2.
- New York, ocean race between S.S. "City of New York" and "Teutonic" won by former by seventeen minutes.—Aug. 15.
- Release of steamer "Nera", belonging to Dr. Peter's expedition, and seized at Zanzibar, to its owners ordered, the owners to pay costs incurred by the captors.—Aug. 6.
- Seizures, Boston, Mass., of two Canadian schooners for not reporting at Custom House.—Aug. 15.
- Queenstown Ireland, S.S. "City of Paris" heats Eastern record by 45 minutes time from Sandy Hook, 5d. 23 hrs. 40 min.—Aug. 14.
- Spanish bark "Victoria" from Havana for St. John, N.B., strikes on Murray Ledges near Grand Manan, and sinks on 1st August. Crew arrive at Eastport, Me.—Aug. 5.
- Spithead, "Black Prince" and "Invincible" come into collision, and both much damaged.—Aug. 6.
- Syracuse, N. Y., the "Jessie Lang" sunk in collision with the "Widawake", Miss Yao Wormer of Phoenix drowned.—Aug. 21.
- Thousand Island Park, steamer "Sport" injured by running into sank steamer "Vicary" off.—Aug. 23.
- Victoria, B.C., schooner "Black Diamond" seized by U. S. cutter "Rush" sails into the harbor.—Aug. 3.
- Warwick County, Va., steamer "Oro Dominion" collides with sloop "Ella May", J. H. Coombs, captain of sloop, and two of crew drowned.—Aug. 7.
- Watertown, N.Y., schooner "Vickery" strikes shoal and sinks, 27,000 bush. corn lost.—Aug. 16.
- Sioux reservation, Dakota, requisite number of signatores for opening of, secured.—Aug. 6.
- Smith Mr. Goldwin, interviewed at Winnipeg on French school Question, in Toronto.—Aug. 8.
- Smuggling, Grafton, Dak., ten half-breeds arrested for smuggling.—Aug. 3.
- Smuggling, Hemmingford and Lacolle, P. Q., preventive officers return to Ottawa and report extensive seizures.—Aug. 8.
- Socialism, Berlin police suppressing meetings convened to hear reports from delegates to Paris labor congress.—Aug. 4.
- Soldiers' and Sailors' Monument, Indianapolis, corner stone of laid at.—Aug. 22.
- Spain, Madrid, arrest of twenty-eight municipal officers.—Aug. 15.
- SPORTS, Aquatics, Hanlan Edward, the oarsman, arrives in Toronto, and speaks on the O'Connor and Bearie match.—Aug. 7.
- Aquatics, O'Connor presented with a flag of the Dominion of Canada by Sir Charles Tupper.—Aug. 6.
- Aquatic, Hamilton, Canadian Association of Amateur Oarsmen, annual regatta of.—Aug. 21.

## SPORTS.—Continued.

Baseball, Weir City, Mo., James Hamilton the pitcher breaks his arm in delivering the ball.—Aug. 3.  
 Carnival, Halifax, opening of.—Aug. 5.  
 Chess, Amsterdam, International Congress opens at.—Aug. 26.  
 Cycling, Chicago, F. W. Van Sicken, prominent bicyclist, leaves the city on wheel for Kansas city.—Aug. 7.  
 Jumping, Mattawan Athletic grounds, P. J. Griffin beats the world's record.—Aug. 4.  
 Jumping, Steve Brodie jumps the Pawtucket Falls.—Aug. 8.  
 Lacrosse, Ottawa, Dr. W. C. Cousens resigns the presidency of the club.—Aug. 5.  
 Lacrosse, Ottawa, Captain Seybold resigns.—Aug. 7.  
 Lacrosse, Montreal, Ottawa defeated by, in great match of season.—Aug. 17.  
 Lacrosse, Montreal against Shamrock at Montreal.—Aug. 31.  
 Mattawan Athletic grounds, opening of.—Aug. 4.  
 P.E.I., Clans and Highland sports at.—Aug. 22.  
 Purvis, Miss., "Dud" Renand fined \$500 for participation in the Killrain and Sullivan prize fight.—Aug. 22.  
 Racing, Ebelec, races of Montenech Club begin at.—Aug. 21.  
 Racing, Butte, Montana, "Faust," three year old, beats brother of "Pat Kowit"—Aug. 22.  
 Racing, York, Eng., Great Ebor Handicap won by "King Monmouth."—Aug. 23.  
 Racing, York, Eng., Prince of Wales Plate won by "Margarine."—Aug. 28.  
 Ring, San Francisco, Geo. Lublache beats John Dempsey at, for purse of \$3,500 and championship of America.—Aug. 27.  
 Regatta, Grand Trunk Railway Club, annual, of.—Aug. 31.  
 Ring, Sullivan John L., surrendered to Mississippi officers.—Aug. 1.  
 Ring, Kilrain Jake, arrested at Ocean View, Va.—Aug. 5.  
 Ring, Killaloe, Ont., fight between George Eno and Michael Connors.—Aug. 5.  
 Ring, Jake Kilrain arrested at Baltimore.—Aug. 14.  
 Ring, Purvis, Miss., J. L. Sullivan tried for Kilrain fight.—Aug. 12.  
 Sparring, San Francisco, Pat. Killen arrested while giving an exhibition.—Aug. 7.  
 Toronto, Caledonian Convention sports open at.—Aug. 24.  
 STANLEY H. M., New York *Herald*, special from Zanzibar, says Stanley coming down the coast with Emin Pasha and 19,000 men.—Aug. 9.  
 Stanley H. M., heard from.—Aug. 13.  
 Stanstead Plain, P. Q., Stanstead Live Stock Exhibition, third annual exhibition of.—Aug. 28.  
 Storms, Missouri Valley, twenty persons killed by lightning, damage to crops, etc., \$500,000.—Aug. 12.  
 Storms, Spain, great hurricane sweeps over south of, doing much damage.—Aug. 17.  
 Storm, Watkin's Glen, New York State, terrible damage done at.—Aug. 2.  
 STRIKERS, Cokers, Pittsburg, Va., 1,200 cokers join the ranks.—Aug. 2.  
 Coke, Connelville, Pa., strikers march on Jimtown works of Schoonmaker & Co., and drive the men from work.—Aug. 5.  
 Coke, Connelville, Pa., the McClure and J. M. Schoonmaker offer the men an advance of 6 per cent.—Aug. 6.  
 Coke workers, Pennsylvania, strike made general, over 14,000 men idle.—Aug. 7.  
 Coal, Pennsylvania, ended with victory for the men.—Aug. 9.

## STRIKERS.—Continued.

Dock Laborers, London, joined by coalheavers and bargemen at Lambeth and the Isle of the Dogs.—Aug. 31.  
 Galt, Ont., of iron moulders.—Aug. 13.  
 Hosiery, Womer, Reading, Pa., young women at Hunsiker & Co's mill striko because firm reduced wages.—Aug. 5.  
 London, Dock laborers.—Aug. 16.  
 London, Dock laborers, ten thousand dock laborers parade streets of.—Aug. 19.  
 Miners, Durham miners accept ten per cent. advance offered by the owners.—Aug. 2.  
 Miners, Graetz, refuse an increase of twelve per cent., hold a turbulent meeting, and 200 are arrested.—Aug. 8.  
 New York, pressmen of N.Y. *World* strike.—Aug. 17.  
 North Adams, Mass., shoecutters on strike at.—Aug. 28.  
 Pittsburg, Pa., seven hundred men employed in Sligo mill.—Aug. 13.  
 SUICIDE, Chicago, Ironiek John, one of the anarchists confined in prison cuts the arteries in his arm.—Aug. 1.  
 Drowning, Shawnestown, Ill., Edward Brooks of, after fatally wounding his wife, drowns himself at.—Aug. 32.  
 St. Leon, P. Q., Lessard Joseph, a farmer, drowns himself in a well.—Aug. 5.  
 Sullivan John L., surrendered to Mississippi officers.—Aug. 1.  
 Sullivan John L., at Purdis, Miss., arraigned and placed under \$2,000 bonds to appear before Circuit Court.—Aug. 6.  
 Sumatra, Aceh, fight between natives and a force of Dutch troops, intelligence received.—Aug. 4.  
 Switzerland, Geneva, fifteen Russian anarchists expelled from.—Aug. 23.  
 Telegraph, Pacific Postal Telegraph Company, annual meeting held at New York.—Aug. 7.  
 Timber berth, situate on Nipissing branch of the Petewawa river, purchased by Robert Booth of Pembroke from Alexander Fraser of Westmeath for \$70,000.—Aug. 5.  
 Toronto Brewing and Malting Company, plant of, seized by Hon. Alex. Morris on behalf of holder of bonds not met.—Aug. 8.  
 Trusts, Ice trust, New York, collapse of.—Aug. 3.  
 Trusts, Pittsburg breweries, English Synicate secures control of.—Aug. 15.  
 Turkey, eighty thousand reserves called out.—Aug. 2.  
 Typhoid fever, Chicago, outbreak of, caused by pollution of city's water.—Aug. 8.  
 U. S. Treasury Solicitor undertakes to collect unpaid judgment due to U.S., amount \$20,000,000.—Aug. 20.  
 Virginia State Democratic Convention nominates Captain P.N. McKinney for Governor.—Aug. 15.  
 Wales, Queen Victoria pays her first visit to.—Aug. 22.  
 Walton, Ky., serious affray in a negro dance house. Rube Furrell found shot.—Aug. 4.  
 Warren County, Ga., people organize to exterminate Mormons.—Aug. 20.  
 Waterways convention at West Superior, Wis. The government called upon for additional aid in surveying rivers.—Aug. 7.  
 Watkin's Glen, New York State, terrible damage done by storm.—Aug. 2.  
 Wheat, Vienna, great shortage in Austrian wheat reported at, seriously affecting Chicago market.—Aug. 26.  
 Wilbour, remarkable will of Mrs. Sarah Harvey Wilbour, of Orange, N. J. a millionaire.—Aug. 16.  
 Winnipeg, civic holiday celebrated at.—Aug. 27.



NEW YORK STOCK MARKET CLOSING QUOTATIONS.

AUGUST.

	Thursday 1	Friday 2	Saturday 3	Monday 5	Tuesday 6	Wednesday 7	Thursday 8	Friday 9	Saturday 10	Monday 12	Tuesday 13	Wednesday 14	Thursday 15	Friday 16	Saturday 17	Monday 19	Tuesday 20	Wednesday 21	Thursday 22	Friday 23	Saturday 24	Monday 26	Tuesday 27	Wednesday 28	Thursday 29	Friday 30	Saturday 31	
Canadian Pac.....	71 1/2	72 1/2	73 1/2	74 1/2	75 1/2	76 1/2	77 1/2	78 1/2	79 1/2	80 1/2	81 1/2	82 1/2	83 1/2	84 1/2	85 1/2	86 1/2	87 1/2	88 1/2	89 1/2	90 1/2	91 1/2	92 1/2	93 1/2	94 1/2	95 1/2	96 1/2	97 1/2	98 1/2
C. & N. Y. & T.....	14	14 1/4	14 1/2	14 3/4	15	15 1/4	15 1/2	15 3/4	16	16 1/4	16 1/2	16 3/4	17	17 1/4	17 1/2	17 3/4	18	18 1/4	18 1/2	18 3/4	19	19 1/4	19 1/2	19 3/4	20	20 1/4	20 1/2	20 3/4
Canada Southern.....	52 1/2	53	53 1/2	54	54 1/2	55	55 1/2	56	56 1/2	57	57 1/2	58	58 1/2	59	59 1/2	60	60 1/2	61	61 1/2	62	62 1/2	63	63 1/2	64	64 1/2	65	65 1/2	66
C. & O.....	101 1/2	102	103	104	105	106	107	108	109	110	111	112	113	114	115	116	117	118	119	120	121	122	123	124	125	126	127	128
Del. & Hudson.....	144 1/2	145	146	147	148	149	150	151	152	153	154	155	156	157	158	159	160	161	162	163	164	165	166	167	168	169	170	171
Lackawanna.....	144 1/2	145	146	147	148	149	150	151	152	153	154	155	156	157	158	159	160	161	162	163	164	165	166	167	168	169	170	171
Emp.....	102 1/2	103	104	105	106	107	108	109	110	111	112	113	114	115	116	117	118	119	120	121	122	123	124	125	126	127	128	129
P. do preferred.....	62 1/2	63	64	65	66	67	68	69	70	71	72	73	74	75	76	77	78	79	80	81	82	83	84	85	86	87	88	89
Kan. & Texas.....	101 1/2	102	103	104	105	106	107	108	109	110	111	112	113	114	115	116	117	118	119	120	121	122	123	124	125	126	127	128
Lake Shore.....	101 1/2	102	103	104	105	106	107	108	109	110	111	112	113	114	115	116	117	118	119	120	121	122	123	124	125	126	127	128
Mich. & Nash.....	68 1/2	69	70	71	72	73	74	75	76	77	78	79	80	81	82	83	84	85	86	87	88	89	90	91	92	93	94	95
Missouri Pacific.....	67 1/2	68	69	70	71	72	73	74	75	76	77	78	79	80	81	82	83	84	85	86	87	88	89	90	91	92	93	94
N. J. Central.....	28 1/2	29	30	31	32	33	34	35	36	37	38	39	40	41	42	43	44	45	46	47	48	49	50	51	52	53	54	55
N. Y. Central.....	64 1/2	65	66	67	68	69	70	71	72	73	74	75	76	77	78	79	80	81	82	83	84	85	86	87	88	89	90	91
Northwestern.....	108 1/2	109	110	111	112	113	114	115	116	117	118	119	120	121	122	123	124	125	126	127	128	129	130	131	132	133	134	135
N. Y. Central.....	108 1/2	109	110	111	112	113	114	115	116	117	118	119	120	121	122	123	124	125	126	127	128	129	130	131	132	133	134	135
Nickel Plate.....	105 1/2	106	107	108	109	110	111	112	113	114	115	116	117	118	119	120	121	122	123	124	125	126	127	128	129	130	131	132
N. J. & N. E.....	105 1/2	106	107	108	109	110	111	112	113	114	115	116	117	118	119	120	121	122	123	124	125	126	127	128	129	130	131	132
N. J. & N. E.....	105 1/2	106	107	108	109	110	111	112	113	114	115	116	117	118	119	120	121	122	123	124	125	126	127	128	129	130	131	132
do preferred.....	48 1/2	49	50	51	52	53	54	55	56	57	58	59	60	61	62	63	64	65	66	67	68	69	70	71	72	73	74	75
do preferred.....	48 1/2	49	50	51	52	53	54	55	56	57	58	59	60	61	62	63	64	65	66	67	68	69	70	71	72	73	74	75
Albion & Topinka.....	35 1/2	36	37	38	39	40	41	42	43	44	45	46	47	48	49	50	51	52	53	54	55	56	57	58	59	60	61	62
Oregon Trans.....	35 1/2	36	37	38	39	40	41	42	43	44	45	46	47	48	49	50	51	52	53	54	55	56	57	58	59	60	61	62
Pacific Mail.....	35 1/2	36	37	38	39	40	41	42	43	44	45	46	47	48	49	50	51	52	53	54	55	56	57	58	59	60	61	62
Reading.....	45 1/2	46	47	48	49	50	51	52	53	54	55	56	57	58	59	60	61	62	63	64	65	66	67	68	69	70	71	72
Rock Island.....	45 1/2	46	47	48	49	50	51	52	53	54	55	56	57	58	59	60	61	62	63	64	65	66	67	68	69	70	71	72
St. Paul.....	70 1/2	71	72	73	74	75	76	77	78	79	80	81	82	83	84	85	86	87	88	89	90	91	92	93	94	95	96	97
Texas Pac.....	19 1/2	20	21	22	23	24	25	26	27	28	29	30	31	32	33	34	35	36	37	38	39	40	41	42	43	44	45	46
Union Pac.....	35 1/2	36	37	38	39	40	41	42	43	44	45	46	47	48	49	50	51	52	53	54	55	56	57	58	59	60	61	62
Wabash.....	15 1/2	16	17	18	19	20	21	22	23	24	25	26	27	28	29	30	31	32	33	34	35	36	37	38	39	40	41	42
Western Union.....	84 1/2	85	86	87	88	89	90	91	92	93	94	95	96	97	98	99	100	101	102	103	104	105	106	107	108	109	110	111

**ALBEMARLE HOTEL.**

EUROPEAN PLAN,  
Broadway, Fifth-ave. & 24th-st., New York.  
(MADISON SQUARE.)  
JANVRIN & WALTER, Proprietors.

**HOTEL KAATERSKILL,**

Catskill Mountains, New York,  
Largest and Finest Mountain Hotel in the world. Rates of board moderate.  
W. F. FAIGE, Manager.  
Kaaterskill P.O., Greene Co., New York

**WEST END HOTEL,**

LONG BRANCH,  
SEASON OF 1889.  
Cottages and Restaurant open Saturday, June 8th. Hotel opens June 22nd  
with improvements and additional attractions.  
D. M. & W. E. HILDRETH, Props

**ASTOR HOUSE,**

Broadway, New York.  
On the European Plan. | Rooms \$1.00 and Upwards.  
The accommodations of the Astor will be found first-class in every respect  
Elevator running night and day.  
F. T. KEITH, Manager. | F. J. ALLEN, Proprietor.

**"THE BATES,"**

INDIANAPOLIS, IND.  
Rates, \$2.50 to \$5.00 per day.  
LOUIS REIBOLD, Proprietor.

**PARKER HOUSE,**

BOSTON.  
European Plan. 300 Rooms. \$1.00 and Upwards per day.  
Café of unsurpassed excellence. Private dining rooms for dinner parties.  
E. O. FENCHARD & CO., Proprietors.

**TREMONT HOUSE,**

CHICAGO.  
THE "PALACE" HOTEL.  
JOHN A. RICE & CO.  
Prices, \$3.00 to \$5.00 per day. Special rates made by the week. Rooms  
single or *en suite*, with or without baths.  
MRS. JOHN A. RICE, Manager.

**ALBION HOTEL,**

MARKET SQUARE, - - - TORONTO.  
The best dollar a day house on the continent. Fine rooms; good service  
every convenience. Centrally located for railways, steamboats and street  
cars.  
JOHN HOLDERNES, Proprietor.

**THE PALMER HOUSE,**

TORONTO,  
Corner King and York streets. Specially adapted for Commercial men.  
\$2.00 per day.  
J. C. PALMER, Proprietor.  
Also Kerby House, Brantford.

**ST. NICHOLAS HOTEL,**

EDWARD N. ROTH,  
CINCINNATI, OHIO.  
On the European plan. Location and service unsurpassed. Every modern  
improvement. Rooms, \$1.50 per day and upwards.

**GRAND UNION HOTEL.**

Opposite Grand Central Depot,  
NEW YORK.  
Six hundred rooms at \$1 a day and upwards. Restaurants at moderate prices,  
BAGGAGE TO AND FROM GRAND CENTRAL DEPOT FREE.  
W. D. GARRISON, Manager.

**GRAND HOTEL,**

Broadway, cor. 31st-st., New York.  
ON THE EUROPEAN PLAN  
HENRY MILFORD SMITH & SON, Props.

**THE GRISWOLD,**

DETROIT, MICH.  
Located corner Griswold and Congress-streets. Newly furnished and refitted  
throughout.  
Rates, \$2 per Day.  
ALBERT MAXWELL, Proprietor. | E. T. OSBORN, Manager.

**FOREST CITY HOUSE,**

CLEVELAND, OHIO.  
Best location in the city, and the only hotel fronting on the park. Nearest  
to public buildings, opera house, churches, etc. Street cars pass the house to  
all parts of the city, suburbs and depots. Rates, \$2.50 and \$3 per day.  
TERRILL & INGERSOLL, Proprietors.

**FIFTH AVENUE HOTEL,**

Madison Square, New York.  
The largest, best appointed and most liberally managed hotel in the city,  
with the most delightful and central location. Conducted by HITCHCOCK,  
DARLING & CO., who first opened it to the public.

**THE WINDSOR HOTEL,**

DENVER, COLO.  
Largest and most Elegant Hotel in the West.  
BUSH & MORSE, Proprietors.

**ADAMS HOUSE,**

Washington-st., Boston.  
ON THE EUROPEAN PLAN.  
Three hundred rooms. Private parlors, baths, etc. Best location in the  
city. A strictly first-class house.  
GEO. G. HALL, Proprietor.

**YOUNG'S HOTEL,**

On the European Plan.  
Head of State-st., Boston.  
Greatly enlarged and improved, and now offers superior accommodations for  
both ladies and gentlemen. Noted for the peculiar excellence of its cuisine.  
J. E. WHIPPLE, Proprietor.

**TOWER HILL HOTEL**

AND COTTAGES.  
NARRAGANSETT PIER, R.I.  
Season 1889 opens June 25th.  
CHARLES A. OAKES, New York Office, 145 Broadway, Room 39.

## TO ADVERTISERS.

### HOW TO GET THE MOST SERVICE FOR THE MONEY!

The Advertiser who would be willing to pay twenty-five cents for every family who could be "educated" up to the value of his goods would thus devote \$3,000,000 to educate the 12,000,000 families which make up the 60,000,000 people of the United States. This sum would do the business thoroughly in a year, for it is sufficient to pay for the insertion of a full column in every issue of every publication, and for resetting the matter, making it new in every issue of each separate publication. We will receive and execute the contract.

\$10.—We devote all necessary care to placing small orders for Advertising;—even the smallest! Time is saved by sending check with the order. Often the Advertiser is not possessed of sufficient information on the subject to enable him to judge of the merits of an estimate for advertising, and he decides by the footings of the figures whether he will or will not do the work. Yet the estimate binds the Agent, and makes it improper for him to make any variation in its specifications, however much his judgment may point to material changes which ought to be made. This is specially liable to be the case when the order comes a considerable time after the estimate was made.

\$50.—If you are in the habit of occasionally inserting a small advertisement in a few papers, investing a few dollars, and carefully noting the result, we desire you to make trial of our Advertising Bureau, sending us the advertisement and the money, leaving the selection of the papers to us, and judging of the service rendered by results rather than by names, circulation claims or prices. To make up careful estimates calls for much work. It does not pay to make them indiscriminately for every applicant. If such estimates as are asked for were always given, the Advertiser who wished to expend \$50 would frequently find himself in possession of the scheme which it would cost \$500 or possibly \$5,000 to carry out.

\$100.—The Advertiser who sends his advertisements, asking for the best service possible for one hundred dollars, will often get from five to fifty per cent. more service for his money than he would had he required us to tell him in advance exactly what service we would promise, for when an estimate has been given its plan and specifications must, in a general way at least, control the advertising to be done. It ties the Agent's hands, and prevents his giving his patrons *to-day* a better service than he could have promised yesterday, because yesterday the opportunity had not presented itself: *to-morrow it may have passed!* Some publications are used most economically on contracts for a single issue; in others, insertion for a month may be had as cheaply as for a single week; but in furnishing an estimate in advance, if the Agent attempts to go into details, his correspondence becomes voluminous and the advertiser confused.

\$250.—Prepare a small advertisement and send with check for \$250, or any other sum. The practice of asking the Agent to name his papers in advance compels him to name such as are well known, otherwise there is reason to suspect that his judgment is biased;—*and the best papers do not like to have their rates quoted below their schedule.*

\$500.—Leading newspapers, especially the leading Agricultural newspapers, frequently issue large special editions (of twenty, fifty, one hundred, or even five hundred thousand copies), and solicit advertisement orders from us, on terms which would often be accepted by our patrons if there was time to invite attention to the matter; but the question must generally be decided before there would be time to write and receive a reply, and often the case cannot be fully stated within the limits of a letter.

\$1,000.—If we are given authority to insert advertisements to a limited amount, in such mediums as offer inducements which seem to us specially favorable, we shall not abuse the confidence reposed in us, and shall render statements of whatever is done (if anything) from day to day. When trusted with the placing of an advertisement, we are put upon honor, and are bound in honor to give the best service possible for the money to be used.

\$5,000.—One of the most successful Advertisers we ever had always ordered his advertisements in this way, "Get the best service you can for me for \$5,000," leaving every detail to us. We were thus enabled to say to a Publisher, if you put this in at a large reduction from your rate it will be no criterion for further transactions. It was a surprise to find ourselves so often able to contract for the insertion of that particular advertisement at half rates, in papers which would not permit us to offer their columns at a penny's deviation from their printed schedule. The advertising rates of one New York paper are double those of another which has twice the circulation of the first. Similar discrepancies are not uncommon. The advertisement entrusted to us to be placed in accordance with our judgment often does double service for half the money. A dollar for twenty-five cents.

The Oldest and Largest Roller Casting Estab-  
lishment in New England.

ESTABLISHED 1859

WILD & STEVENS,

MANUFACTURERS OF

Printers' Rollers and Roller Compositions,

No. 148 CONGRESS STREET, BOSTON.

**IT PAYS  
ADVERTISERS  
TO KEEP POSTED.**



pays for a book of more than 200 pages devoted to Newspaper Advertising, and containing information valuable alike to exported and intending advertisers.



pays for a year's subscription to **PRINTERS' INK**, a Journal no advertiser alive to his own interests can afford to be without.

Issued twice a month and containing articles bearing on every branch in advertising; in fact the trade Journal of American advertisers. A sample copy will be sent for Five Cents. Address

**GEO. P. ROWELL & CO'S**  
Newspaper Advertising Bureau,  
10 Spruce St., New York.

**READY, RAPID & RELIABLE FIRE ESCAPE.**

The Best, Safest and Quickest Means of Emptying School and other Dormitories in Case of Fire.

The accompanying cut exhibits the essential features of the contrivance, which may be adapted either to the interior or to the exterior of a building, but preferably to the latter, so as to create no draught for flame or smoke. *C c* represent the floor or, as in the present diagram, platforms which may assume the form of an ornamental balcony. These platforms are secured to the walls by suitable brackets *e e*. Two vertical shafts *f f* pass through the

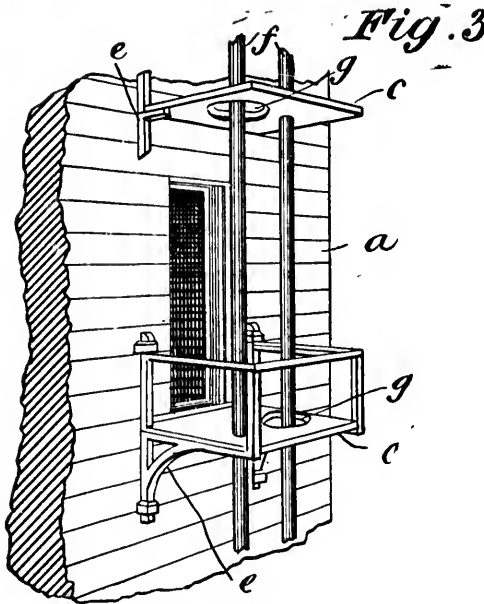

floors or staging from the roof to the ground; *g g* are circular openings which alternate from one side to the other at each succeeding landing. The landing to be placed before a window at every story.

The shaft to the left of *f*, and which is secured to the next platform above (not shown in the figure), is firmly clasped, not with the hands, but with the legs and arms, and the person slides down the shaft to the next landing below, regulating with ease, by the pressure of his limbs, the rapidity of the descent.

Inventor and Patentee,  
 Rev. ARTHUR JONES,  
 St. Mary's College, MONTREAL.

M. HICKS.

E. O'BRIEN.

**M. HICKS & CO.,**

AUCTIONEERS & COMMISSION MERCHANTS,

1821 and 1823 Notre Dame Street, MONTREAL.

Advances made on consignments.

Charges moderate and returns prompt.

SALES OF

Household Furniture, Farm Stock, Real Estate and General Merchandise solicited.

ALWAYS ON HAND:

Large consignment of New Household Furniture of American and Canadian Manufacture.

SPECIALTIES:

Turkish Rugs, Japanese Art Objects, Fine Pictures by old and modern masters, Foreign Fine Arts, &c.

VISITORS WELCOME.

**Photo - Engraving.**

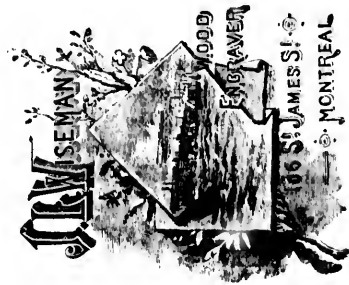

Pen Drawing & Map Etching.

## WHO SUBSCRIBE TO THE

## "INDEX OF CURRENT EVENTS."

The "Index of Current Events" is much appreciated not only by the press of Canada and the United States, but also by the public men of both countries. Its list of subscribers includes such great newspapers as the Philadelphia *Ledger*, the Boston *Transcript*, the New York *World*, the Cincinnati *Enquirer*, the Brooklyn *Eagle*, the Toronto *Empire*, the Cleveland *Leader*, the Chicago *Herald*, the Cincinnati *Post*, the New York *Morning Journal*, the Chicago *Daily News*, the Indianapolis *Journal*, the New York *Star*, the Troy *Budget*, the Chicago *Staats Zeitung*, the New York *Nation*, the Troy *Press*, the Washington *Star*, the Chicago *Inter-Ocean*, and many less known but important newspapers. Some of these papers are well known to keep admirable indexes of their own, yet find it advantageous to subscribe to the INDEX OF CURRENT EVENTS. We have the honor to include among our subscribers, Her Majesty's Privy Council for Canada; also, Sir John Macdonald, G. C. B. Premier of the Dominion, Sir Hector Langevin, Minister of Public Works, Sir A. P. Caron, Minister of Militia, the Hon. G. E. Foster, Minister of Finance, the Hon. Mackenzie Bowell, Minister of Customs, the Hon. J. A. Chapleau, Secretary of State, the Hon. John Costigan, Minister of Inland Revenue, the Hon. John Haggart, Postmaster General, the Hon. John Carling, Minister of Agriculture, the Hon. C. H. Tupper, Minister of Marine and Fisheries, the Hon. Commissioner of Agriculture and Colonization Quebec, the Hon. Boucher de La Bruère, late speaker of the Legislative Council, Quebec, the Hon. Lieutenant Governor Royal, Mr. Ernstus Wüman, the Hon. Minister of Public Works, Toronto. The Librarian of Parliament, the House of Commons Reading Room and the Librarians of many of the Provinces of the Dominion and States of the Union subscribe to the *Index*. Among the well known public librarians who subscribe are, Mr. J. C. Hurlbut, Librarian of the American Geographical Society, New-York, Mr. W. A. Bardwell, Librarian of the Brooklyn Library, Mr. W. H. Brett, Librarian of the Cleveland Public Library, Mr. F. P. Jordan, Librarian of the Public School Library, Battle Creek, Michigan, Mr. W. T. Peoples, Librarian of the Mercantile Library, New-York, Mr. Robert E. Rich, Librarian of the Public Library, Portsmouth, N.

H., Mr. J. P. Dunn, Librarian of the Indiana State Library, Indianapolis, Mr. F. W. Vaughan, Librarian of the Social Law Library, Boston, Mr. James G. Barnwell, Librarian of the Philadelphia Library, the Librarian of the Providence Public Library, the Librarian of the Free Public Library, San Francisco, Mr. John M. Doane, State Librarian of Ohio, Mr. William H. Egle, State Librarian of Pennsylvania, Mr. M. Chamberlain, Librarian of the Boston Public Library, Mr. A. W. Whelpley, Librarian of the Cincinnati Public Library and Mr. C. B. Tillinghart, State Librarian of Massachusetts. The leading bankers (including the Bank of Montreal), brokers, lawyers and hotel keepers of Canada, and many clergymen also keep the *Index* on file.

What is thought of the *Index* may be gathered from the numerous entirely unsolicited expressions of approval sent in by well known public men, of which the following are specimens:

MR. MARTIN J. GRIFFIN, LIBRARIAN OF PARLIAMENT, OTTAWA, writes:—I am sending you a subscription for two copies of your "*Index*," which will be most useful and which deserves encouragement. If you will take particular pains to give the dates and figures of elections and the dates of speeches of public men, with reference also to the place at which the speech was delivered, you will do a very grateful thing for public people and editors, and I may add librarians.

MR. JOHN M. DOANE, STATE LIBRARIAN OF OHIO, writes:—Enclosed please find six dollars, in payment for State Library subscription to the "*Index of Current Events*" for 1889.

I regard it as a very valuable publication, and hope that you may meet with such success as to warrant its continuance, for it will grow more valuable every year.

MR. HERRIES, OF THE BROOKLYN *Eagle*, writes:—"I congratulate you most heartily upon having done a good thing, a very good thing, in starting the "*Index*" enterprise. I hope I may have the joy of congratulating you upon your success a year hence. A man with *Index* on the brain is one after my own heart. My judgment was formed upon Number 1; if the indexing is kept up as thoroughly in all subsequent numbers it will be a great help to us."

SIR CHARLES TUPPER, BART., HIGH COMMISSIONER FOR CANADA, writes:—"It seems to me to be a very useful publication, and one that will be valuable for reference purposes."

MR. BURN, ASSOCIATE EDITOR OF THE PHILADELPHIA *Public Ledger* writes:—"Your *Index* is highly appreciated at this office, where it has long been a desideratum."

MR. COLQUHOUN OF THE "TORONTO *EMPIRE*," writes:—"Allow me to congratulate you most cordially upon your admirable *Index*. The idea and its execution are alike worthy of all praise."

MR. VALEN, OF THE "NEW-YORK *MORNING JOURNAL*," writes:—"I find the *Index* of great value, saving, as they do, much valuable time in looking up important events."

MR. WILL A. WOODWARD, REC. SEC. MASS. PRESS ASSOCIATION, writes:—Enclosed please find subscription for one year for "*Index of Current Events*." I have examined the specimen sent me with much interest and do not hesitate to commend it as an invaluable assistant in the newspaper office. The amount of time and labor it is calculated to save, cannot be compensated by one hundred times its subscription rate.

Commencing with Vol. II No. 1 (the dates given in the *Index* are the actual dates of the occurrences; not as formerly the dates of publication).

The *Index* is published four times a month; but to form a complete file for the year it is necessary to preserve only the first issue in each month.

The ...mediate issues contain the news of the current month to date.

The subscription is \$6 per annum, payable yearly or half yearly in advance. Remittances should be made to

HENRY DALBY,

P. O. Box 864,

MONTREAL, Que.

# THE INDEX OF CURRENT EVENTS.

VOL. II, No. 36.

MONTREAL, OCTOBER 7, 1889.

\$6.00 PER ANNUM.  
PUBLISHED WEEKLY.

## SEPTEMBER.

**ACCIDENTS.** Drowning, Mexico, Zimassa, State of Hidalgo. Eight persons drowned in flood.—Sept. 1.  
 Marshall, Staten Island, N. Y., J. Godfrey killed by blow of ball.—Sept. 21.  
 Cliff, Quebec, terrible collapse of cliff, burying 175 persons.—Sept. 19.  
 Cliff slide, Quebec, P. Q., details of disaster given.—Sept. 20.  
 Cliff slide, Quebec, funerals of victims take place, 35 bodies recovered to date.—Sept. 22.  
 Cliff slide, Quebec, inquest on dead resumed, complaints as to lack of energy, etc., etc.—Sept. 21.  
 Cliffslide, Quebec, mass meeting of citizens censure Government, Joe Kemp rescued after 4 days burial.—Sept. 24.  
 Quebec, Joe Kemp, victim of Cliff slide, dies, angry spirit manifested by citizens of.—Sept. 25.  
 Cliff slide, Quebec, jury return verdict censuring Federal Government and city corporation.—  
 Drowning, Fall River, five persons drowned at, through overturning of boat.—Sept. 27.  
 Drowning, Lake Erie, pleasure yacht wrecked in, nine persons drowned.—Sept. 17.  
 Drowning, Montreal, Adolphe Perreault, at Lacine.—Sept. 8.  
 Drowning, Denver, Col., ten miners drowned by flooding of White Ash mine.—Sept. 9.  
 Drowning, St. Joseph, Russell Co., two men named Pariseau drowned whilst boating on the Ottawa river.—Sept. 1.  
 Electricity, New York, Henry D. A., superintendent of construction of East River Electric Light Company, killed at, by electric shock.—Sept. 2.  
 Electricity, New York, J. Maty roasted to death by live wire.—Sept. 13.  
 Electricity, New York, two men knocked off pole by current, and killed at.—Sept. 21.  
 Explosion, Antwerp, great fire in cartridge factory, extinguished, 200 lives reported lost.—Sept. 8.  
 Explosions, Antwerp, estimate of loss by recent cartridge factory explosion 35,000,000 francs.—Sept. 10.  
 Explosion, Antwerp, full extent of damage made known, 35 persons killed.—Sept. 12.  
 Explosion, Braddock, Pa., furnace in Thompson's Steel Works explodes, fatally injuring many persons.—Sept. 26.  
 Explosions, Cressona, Pa., powder mill explodes at, killing two men.—Sept. 26.  
 Explosions, New Hamburg, Ont., boiler in engine house of 11 flouring mills explodes, killing one person and causing much damage.—Dec. 14.  
 Explosion on H. M. S. "Ajax"—Sept. 4.  
 Carbondale, Ill., boiler explodes killing 5 persons.—Sept. 9.  
 Explosion, Dublin, bomb exploded on Smith-Barry's property, destroying offices and other buildings.—Sept. 8.  
 Dynamite, Fairmont, W. Va., cartridge explodes on railroad between Fairmont and Clairmont, killing two men and injuring others.—Sept. 8.  
 Explosion, Morgantown, W. Va., Kinsey John, Kerby Wm., killed and Kirk John, fatally injured by explosion of fire damp in Cullagton Coal mine.—Sept. 8.  
 Explosions, Oakland, Cal., boiler in door factory explodes, killing four men.—Sept. 10.  
 Explosion, Penitencik, Scotland, fifty miners killed.—Sept. 5.  
 Fires, Albany, McArde's rag factory burnt, several people perish, loss \$80,000.—Sept. 9.  
 Fire, Aalwern, Belgium, Cartridge Factory totally destroyed; estimated loss of 200 lives.—Sept. 6.  
 Fires, Beauharnois, P. Q., whole square of houses burnt at, loss \$40,000.—Sept. 15.  
 Fires, Charleston, Va., unknown incendiaries attempt to destroy, loss \$100,000.—Sept. 25.  
 Fires, Danly, N. Y., business portion of city burnt.—Sept. 13.

## ACCIDENTS.—Continued.

Fires, forest, Montana, extinguished by snow-storm, after raging six weeks.—Sept. 3.  
 Fires, forest, Portland, Me.—Sept. 19.  
 Fires, Greece, Pentelicos, 27,000 trees burnt.—Sept. 11.  
 Fires, Kensington, P. E. I., great fire sweeps over, loss \$100,000, forest fires also raging.—Sept. 23.  
 Fires, London, Chemical Works of Burroughs & Co. burnt, loss \$20,000.—Sept. 10.  
 Fires, Louisville, Ky., Bamberger, Bloom & Co., dry goods house, burnt, 4 firemen killed, loss \$1,000,000.—Sept. 15.  
 Fire, Manstee, Mich., Buckley and Douglass' mill burnt. Loss \$125,000.—Sept. 27.  
 Fires, Melbourne, Australia, George's Factory emporium burned, 3 men killed, loss \$200,000.—Dec. 14.  
 Fires, Messoula Co., Mont., great forest fire causes \$1,000,000 losses.—Sept. 8.  
 Fires, Nova Scotia, great forest fires raging in.—Sept. 15.  
 Fires, New Brunswick, forest fires do immense damage.—Sept. 13.  
 Fires, Shoal Lake, Man., burnt, loss \$50,000.—Sept. 11.  
 Fire, Trenton, Works of Gilmour & Co., Trenton, destroyed by fire, damage \$20,000.—Sept. 4.  
 Fire, Williamsburg, N. Y., sugar at of Dick Meyer & Co., at, destroyed by, damage estimated \$40,000.—Sept. 7.  
 Fire, Wrightsville, Pa., police station and five barns destroyed by.—Sept. 7.  
 Floods, City of Celaya inundated.—Sept. 29.  
 Floods, Johnstown, 324 persons reported drowned in late flood.—Sept. 9.  
 Floods, Mexico, town of Ilaoculla entirely destroyed.—Sept. 6.  
 Floods, Plainfield, N. J., water rises 4 ft., causing great damage.—Sept. 18.  
 Land slides, Mexico, Vera Cruz, heavy land slides occur in, causing great damage.—Sept. 21.  
 Lightning, Albany, Ga., H. H. Rouse, John Shivers, J. W. Shivers, killed by.—Sept. 6.  
 Mining, Penitencik, Scotland, fire in iron stone mine lens in workmen, causing many deaths.—Sept. 6.  
 Railway, Englewood, Ill., C. R. I. and P., passenger train run into by freight, fourteen persons killed.—Sept. 21.  
 Railway, Boston & Maine, two freight trains collide on Boston & Maine R. R., killing two men.—Sept. 21.  
 Railway, Morristown, Pa., Giuseppe Plantello killed, and several others injured by collision to hand truck on Philadelphia and Reading railroad.—Sept. 3.  
 Railway, Ohio, collision on Nickle Plate R. R. causes loss of \$100,000.—Sept. 12.  
 Railway, Tiogo Junction Ry., southbound train from Elmira collides with engine at, killing 25 persons.—Sept. 16.  
 Railway, Washington, Passenger train on Pennsylvania R. R. collides with freight, 2 killed.—Sept. 13.  
 Shooting, Ship Harbor, N. S., two men fatally shot by companion while hunting.—Dec. 14.  
 Watersport at Ceno Gorle, Mexico, causes several deaths.—Sept. 20.

**AFRICA.** Zanzibar, Sultan of, concedes Lamu Islands and Benanger coast line to British East Africa Co.—Sept. 2.  
 Dr. Peters recalled, expedition for relief of Emin Bey abandoned.—Sept. 4.  
 Soudan, Germans blockade.—Sept. 8.  
 Capt. Wissman offers £5,000 for head of Chief Bushire for threatening interior mission station.—Sept. 11.  
 Capt. Wissman's police destroy town of Kondutshi.—Sept. 13.  
 Prince Bismarck refuses to grant a charter to S. W. Africa Company.—Sept. 14.  
 Morocco, Capt. and crew of Spanish vessel captured off coast of, brought into interior by natives.—Sept. 17.

## AFRICA.—Continued.

Sultan of Zanzibar authorizes English and German commanders to search for slaving dhows, and claims freedom to all entering his domains after November.—Sept. 21.

Shipping, Morocco, Capt. of Spanish ship, seized by Moors off, dies from effects of ill usage.—Sept. 25.

Lord Salisbury sends telegram to Sultan of Morocco advising reparation to Spain for Rif incident.—Sept. 26.

Capt. Wisman reports that exportation of slaves in his territory has stopped.—Sept. 28.

Agricultural Association, Sherbrooke, Eastern Townships Agricultural Association meeting of, at Sherbrooke, Q.—Sept. 3.

America, all nations of, except San Domingo, consent to participate in International Congress at Washington.—Sept. 9.

Annexation of Canada discussed by U. S. Senate Committee at.—Sept. 11.

Anti-alcohol Congress at Paris recommends to all governments prohibitory duties on alcohol, and exemption of tea and coffee from duties.—Sept. 2.

Anti-Jesuit question Mr. Chapleau, at Otterburn Park, P.Q.—Sept. 5.

Anti-Jesuit Question, Privy Council refuse to refer Jesuit estate case to Supreme Court.—Sept. 12.

Art, Rheims, France, Madame Pommeroy, purchases Millet's "Gheneuses" for presentation to the Louvre.—Sept. 21.

Athens, spread of cholera reported at.—Sept. 11.

Anatolia, heavy snow throughout country.—Sept. 19.

Baltimore, Md., celebration of defence of, held.—Sept. 9.

BEHRING SEA, schooner "Minnie" arrives at Victoria after being seized July 15, and sent to Sitka by the "Rush".—Sept. 2.

Schooner "Lily" arrives at Victoria, reports boarded by U. S. Revenue cutter "Rush," 333 seal skins confiscated, and schooner ordered to Sitka.—Sept. 6.

Official Report of Capt. Shepard commanding cutter "Rush" received at Treasury, Washington.—Sept. 12.

Bell Telephone Co. accept the act allowing increase of stock to \$12,000,000.—Sept. 12.

Berlin, complaint laid against American Consul by merchants of.—Sept. 10.

Births, Mrs. Snell, of Idaho, gives birth to six children.—Sept. 20th.

Boading, Washington, D. C., Articles 854 and 908 of Customs regulations relating to transportation in bond amended at.—Sept. 21.

Boston, American merchants give evidence before Senate Committee reciprocity with Canada wanted.—Sept. 12.

Boston, merchants clamour for reciprocal trade with Canada before Senate Committee.—Sept. 13.

Brewers, American brewers combine for protection against English beer syndicate, capital \$100,000,000.—Sept. 14.

British, S.S. "Vertumnus" wrecked off P. Lookout, L.I., crew saved.—Sept. 18.

Canada, Ottawa, meeting of Equal Rights Association of, endorse Manitoba Government's action regarding separate schools and French language.—Sept. 18.

Cayuga, Indians claim \$5,000,000 damages against State of New York.—Sept. 23.

Chamberlain Joseph, at Birmingham, advocates for Ireland equally with England and Scotland denominational endowment for educational purposes.—Sept. 2.

Champlain, Huddersfield, Eng., Joseph Chamberlain, in speech at, predicts continuance of union between Liberal Unionists and Conservatives, until agitation on separation of England and Ireland was killed.—Sept. 17.

Chamberlain, Huddersfield, Joseph Chamberlain advocates formation of new nationalist party to effect internal reforms in Great Britain.—Sept. 18.

Chapleau Hon J. A., at Otterburn Park, speaks on Jesuit Estates question.—Sept. 5.

Charlottetown, Battery of P.E. Island took first prize in artillery competition at Grosse Island, Que.—Sept. 18.

Chicago, Ladies of, form association to prosecute gamblers of.—Sept. 26.

Chicago, two English syndicates close purchase of U.S. industries for \$50,000,000 at.—Sept. 30.

China, Government of, meditate measures of retaliation against United States for exclusion of Chinese.—Sept. 24.

China, Province of Canton, rich gold mines discovered in.—Sept. 27.

Cholera appears in Bagdad and Western Persia.—Sept. 18.

Churchill Lord L., speaking at Machynlleth, Wales, opposes Welsh home Rule, and disestablishment of Welsh church.—Sept. 8.

Cigarmakers, International Cigarmakers Union sit at, New York.—Sept. 17.

Cornwall, annual fair opens.—Sept. 13.

Cotton, Blackburn, cotton spinners resolve to destroy cotton corner in.—Sept. 24.

Cotton, estimated cotton reserve in England reported short by 30,000 bales.—Sept. 28.

Cotton, Liverpool, master and operative cotton spinners attempt to break Cotton, Liverpool, cotton corner collapse.—Sept. 30.

CRETE, Turkish troops occupy Selimas.—Sept. 4.

Athens, papers state that the Porte has granted demands of Cretans.—Sept. 9.

Porte sends 40,000 and warships to guard.—Sept. 11.

ring by working half time during month.—Sept. 15.

Governor of, banishes four Christians.—Sept. 14.

Greek Government send protest to Porte against measures adopted by Chaker Pasha, governor of.—Sept. 17.

Arrest of Christians by Turks still continuing.—Sept. 18.

Christians maltreated by Turks flee to mountains.—Sept. 25.

Greek Government send gun boat to, for protection of leaders of Insurgent Committee.—Sept. 25.

CRIME, Absconders, Montreal, Napoleon Brillou, traveller for Messrs. Bourgeon and Herrou, absconded.—Sept. 2.

Attempted murder, May's Landing, Mrs. Roy Hamilton sentenced to ten years penitentiary for assault.—Sept. 19.

Burglary, Quebec, Cardinal Taschereau's palace burglarized.—Sept. 18.

Conspiracy, New York, Mrs. Swinton and her son Joshua Mann arraigned for grand larceny by Robert Ray Hamilton.—Sept. 4.

Embezzlement, Winnipeg, Sproule, acting Chief of police at Rat Portage, arrested for embezzlement.—Sept. 19.

Rape, Montreal, strong evidence in favor of Heaneasy and Mulcahy in Roberts rape case given.—Sept. 13.

Letter stealing, Montreal, Postmaster Boucher found guilty of stealing a registered letter.—Sept. 17.

Letter stealing, Montreal, Postmaster Boucher sentenced to seven years penitentiary for stealing decay letters.—Sept. 24.

Letter stealing, Montreal, St Jean acquitted.—Sept. 4.

Rape, Montreal, a verdict of guilty returned in Mulcahy case.—Sept. 13.

Rape, Montreal, M. Mulcahy sentenced to 14 years penitentiary for assault on Miss M. Roberts.—Sept. 24.

Robbery, Belton, Pacific Express car robbed of \$10,000 at.—Sept. 19.

Post office robbery, Montreal, St Jean acquitted.—Sept. 5.

Crofter, Immigration, J. C. Colmer, C.M.G., sect. to High Commissioner's office, London, Eng., arrives at, to visit Crofter settlement in Northwest.—Sept. 23.

Customs, collector of Customs at Cape Vincent, N.Y., ordered to remit duties on coast of repulsing Canadian S.S. "St. Lawrence".—Sept. 11.

David L. O., M.P., Montreal East, gives his annual address to his constituents at Montreal.—Sept. 9.

DEATHS, Derry, Catholic Bishop of.—Sept. 1.

Allen rev. John, Montreal, Chaplain of St. Vincent de Paul penitentiary.—Sept. 29.

Boale J., ex-Surgeon General of U.S. Navy.—Sept. 25.

Bombay, India, Catholic Archbishop of.—Sept. 28.

Bennington, Vt., Hon. A. E. Touzalin, President of C. B. and N. W. R. R., dies at.—Sept. 13.

Clarke ex-Attorney General of Manitoba, bursts blood-vessel on C.P.R. Railway near Medicine Hat.—Sept. 13.

Collins Wilkie, novelist, at London.—Sept. 23.

Cambria, Duke of, dies.—Sept. 26.

Cook Eliza, at Wimbledon, Eng., poetess.—Sept. 25.

Cox Samuel Sullivan, Member of Congress for New York.—Sept. 10.

Faidherbe General, at Paris.—Sept. 29.

Farnie, the librettist, at London.—Sept. 23.

Gouderham Wm., at Toronto.—Sept. 12.

Genet H. W., of New York ward politician.—Sept. 6.

Judge James dies at Halifax.—Sept. 20.

Lowell Hon. William, Auburn, Me.—Sept. 6.

Mackarnes, Rt. Rev. J. F. Bishop of Oxford, dies.—Sept. 17.

Monaco, Charles III., prince of, dies.—Sept. 11.

Paine J., celebrated American marksman, dies at Paris.—Sept. 11.

Payson J. W., author, dies at Hyde Park, Mass.—Sept. 18.

Queen of Long Island dies.—Sept. 15.

Rae Jackson, of Montreal.—Sept. 7.

Sand, Maurice Dudevant, painter and litterateur, son of Georges Sand.—Sept. 5.

Savary Charles Joseph, at Ottawa, member of Legion of Honor, ex-deputy Minister of Justice, ex-Director of Bank of Lyons, ex-editor *La Canada*, &c.—Sept. 9.

Snawalter Samuel C., of Dayton, Ohio, of blood poisoning, caused by an injection of the Elixir of Life.—Sept. 2.

## DEATHS.—Continued.

- Schiavino Cardinal, dies at Rome.—Sept. 24.  
 Smith Hon. Sidney, Colbourn.—Sept. 27.  
 Slocote Hon. Mr. Justice, at Three Rivers.—Sept. 6.  
 Stevenson, P. S., president of the New Brunswick Railway, at Montreal.—Sept. 8.  
 Vaughan Fred S., at Montreal, captain in Royal Scots.—Sept. 9.  
 Diphtheria appears in Toronto.—Sept. 24.  
 Diplomatic, Germany and United States, Mr. Phelps, new U.S. minister, presents his credentials to Emperor William.—Sept. 26.  
 Divorce, Flack case, New York, Grand Jury, find indictments against J. A. Flack, W. L. Flack and Mrs. Raymond, etc., etc.—Sept. 24.  
 Earthquakes, France, western.—Sept. 5.  
 Earthquakes, Walkesbarre, Pa., sharp shock felt at.—Sept. 10.  
 ECCLESIASTICAL, France, Minister of Justice issues circular reminding bishops and clergy of prohibition against interference in elections.—Sept. 6.  
 Baltimore, Cardinal Gibbons condemns unveiling of Brunu statue in Rome.—Sept. 13.  
 Jewish New Year celebrated.—Sept. 26.  
 Marseilles, Bishop of, issues protest against circular of Minister of Justice, prohibiting clergy from taking part in elections.—Sept. 8.  
 Montreal, Caré Sentene denounces Labor Day from pulpit.—Sept. 7.  
 Montreal, Synod of, of Quebec, Province of, Church of England in Canada opens at.—Sept. 11.  
 Montreal, P. Synod approve of free church sittings.—Sept. 12.  
 Montreal Provincial Synod discuss methods of raising money for church purposes.—Sept. 14.  
 Montreal Provincial Synod resolve on establishing uniform series of Sunday School lessons.—Sept. 15.  
 Montreal Provincial Synod discuss consolidation of branches of Episcopal church, and intercommunion.—Sept. 16.  
 Montreal Provincial Synod discuss Divinity degrees and Theological Colleges, Canon passed by Upper House.—Sept. 17.  
 Montreal Provincial Synod, Jesuit question introduced, continuation of debate on Divinity degrees, divorce discussed.—Sept. 18.  
 Montreal Provincial Synod I resolve to petition Dominion Parliament on Sabbath observance. Jesuit question discussed.—Sept. 18.  
 Montreal Provincial Synod close session with debate on Jesuit question.—Sept. 19.  
 Montreal, R.C. Archbishop of, appoints 18 cures.—Sept. 30.  
 Montreal, fifteen appointments made in R.C. archdiocese of.—Aug. 23.  
 Ordination by Archbishop Fabre at St. Patrick's, Montreal.—Sept. 1.  
 Quebec, Father Paradis summoned to return from Rome.—Sept. 18.  
 Rome, Mgr. Zigliara pronounced probable successor to Leo XIII.—Sept. 16.  
 Rome, Pope sends protest to French government against measures adopted to prohibit clergy from taking part in elections.—Sept. 17.  
 Rome, The Pope expresses displeasure at Catholic dissensions in Canada, reported.—Sept. 7.  
 Rome, Pope decides not to leave.—Sept. 8.  
 Smith Mr. W. H. pays £22,000 for building a new church at Portsea, Eng.—Sept. 24.  
 Toronto, Bishop Walsh appointed Archbishop of.—Sept. 15.  
 Three Rivers, Rev. Fathers Grenier and Martineau, last Jesuit priests in Three Rivers, return to Montreal.—Sept. 9.  
 Volna, Russia, 8,000 Roman Catholics join Greek Church.—Sept. 8.  
 Walsall, Eng., Rev. Mr. Barfield mysteriously disappears.—Sept. 12.  
 Educational, Baltimore, dispatch from, reports failure of funds of Johns Hopkins University.—Sept. 7.  
 Educational, New Haven, Professor Loomis, of, bequeathes \$300,000 to Yale University.—Sept. 17.  
 Educational, Ottawa, Attorney General Martin of Manitoba states that Government of, will abolish the official languages in Province, and separate schools.—Sept. 11.  
 Educational, Quebec, Father O'Leary appointed professor of English in Quebec Seminary.—Sept. 10.  
 ELECTIONS, Richelieu Co., Que., electors of, ask Mr. Tassé of *Le Minerve* to accept Conservative nomination.—Sept. 11.  
 Cardwell, petition in Cardwell election case dismissed at Toronto.—Sept. 28.  
 Richelieu, P.Q., Canada, J. A. Massé, elected conservative candidate for.—Sept. 23.  
 Dennis, Man., Conservatives of, elect R. Champion to oppose Hon. Mr. McLean, Provincial Secretary.—Sept. 15.  
 Dundee, Conservatives refrain from opposing Gladstonian nominee.—Sept. 20.  
 Dundee, J. Long, liberal, elected to House of Commons for.—Sept. 25.

## ELECTIONS.—Continued.

- London, Hon. H. Chaplin re-elected to Parliament.—Sept. 27.  
 Montreal, Court of Review unseat Mr. Bazinet, ministerial member of Legislative Assembly for Joliette County.—Sept. 23.  
 New Jersey, Gen. E. H. Grenb nominated for Governor of.—Sept. 17.  
 Santa Fe, N.W., Constitutional Convention at, refuse to permit incorporation of woman suffrage.—Sept. 10.  
 Trenton, N.J., Lion Abbott nominated for governor.—Sept. 10.  
 Electricity, Kansas City, Mo., National Association of Fire Engineers denounce overhead wires.—Sept. 24.  
 Emancipation, twenty-seventh anniversary of Pres. Lincoln's emancipation proclamation.—Sept. 23.  
 Engineering, Montreal, American Mining Engineers visit city.—Sept. 5.  
 England, great excitement in court circles over aggressive domination of Prince Henry of Battenburg.—Sept. 16.  
 Executions, Morehead, Minn., Thos. Brown, for murder of policeman Ball.—Sept. 20.  
 Exhibitions, Montreal, Horticultural Society open annual Flower and Fruit show, at.—Sept. 17.  
 Exhibitions, Hochelaga Exhibition, Montreal, opened.—Sept. 20.  
 Exhibitions, Toronto, great exhibition opened by Sir J. McDonald.—Sept. 10.  
 Exhibitions, Toronto, indignation caused by dancing at.—Sept. 11.  
 Fairs, Ottawa, Central Canada Fair opens at.—Sept. 7.  
 FAILURES, Boston, Douglas Axe Co., liabilities between \$500,000 and \$1,000,000.—Sept. 6.  
 Halifax, N.S., New, White & Co., of, liabilities \$90,000.—Sept. 17.  
 New York, T. B. Musgrave, stock operator, liabilities \$100,000.—Sept. 3.  
 New York, Pagenstecher & Co., petroleum exporters, liabilities \$300,000.—Sept. 26.  
 Toronto, Campbell Bros., of St Albani Ward, lumber merchants.—Sept. 5.  
 Vienna, Dubell & Sons, famous upholsterers.—Sept. 4.  
 Faenice, Albania, inhabitants of, raid villages in search of food.—Sept. 8.  
 FRANCE, Boulanger claims right to be tried by court-martial.—Sept. 5.  
 Boulanger informs Great Britain, that if successful in his political projects, he will establish free trade in France.—Sept. 8.  
 Boulanger addresses electors of Montmartre.—Sept. 13.  
 Dragageau, M. Clemenceau in speech furiously attacks M. Ferry's policy.—Sept. 19.  
 Editor of *Cocarde* imprisoned and fined for purloining court documents.—Sept. 4.  
 Election, Prefect of Seine refuses to accept candidacy of, to Chamber of Deputies from members of Boulangist party.—Sept. 11.  
 Elections, Boulanger reported elected.—Sept. 22.  
 Elections, returns from 536 electoral divisions show election of 217 Republicans and 153 anti-Republicans. Re-ballots necessary in 106 districts.—Sept. 23.  
 Elections, Boulanger states that he has no hope of majority in New Chamber of Deputies.—Sept. 24.  
 Paris, Elections, Constitution and Government greatly sustained by result of.—Sept. 24.  
 Elections, The Berlin *Zeitung* criticises French.—Sept. 24.  
 Elections, M. Goblet abandons contest for seat in Chamber of Deputies.—Sept. 25.  
 Elections, Paris, municipal commission decide that votes cast for Boulanger in Montmartre are null and void.—Sept. 26.  
 Elections, Ex Pres. Grey states elections will give France a more stable government.—Sept. 27.  
 Elections, Boulanger issues address to electors of Montmartre.—Sept. 28.  
 Formation of a new army corps for district of Rheims begun.—Sept. 17.  
 French forces in Savoy inspected by Minister of war.—Sept. 18.  
 Great excitement in, over coming elections.—Sept. 16.  
 Government report on crops shows 7,100,000 hectares sown with wheat this year.—Sept. 13.  
 Paris, Bi-Metallic Congress opens at.—Sept. 11.  
 Paris, Esclafete state that Germany will place army corps in Belgau frontier.—Sept. 12.  
 Paris Exhibition, introduction of bull fighting unsuccessful.—Sept. 13.  
 International Exhibition, Paris, Pres. Carnot distributes awards at.—Sept. 28.  
*Le Figaro* and *Temps* in appeal to Conservatives point out that country will not endure Boulangism or Royalism.—Sept. 26.  
 Paris, Gladstone visits International Exhibition at, speaks enthusiastically of America.—Sept. 7.  
 Paris, a session of Bi-metallic Congress, Dana Horton defends Bi-metallicism.—Sept. 13.



## FRANCE.—Continued.

- Paris, *Le Petit Journal* savagely attacks M. Clemenceau.—Sept. 17.
- Paris, Police Tribunal of, fines M. Lejeune, member Chamber of Deputies, 325 francs for keeping gambling house.—Sept. 14.
- Paris, *Le Petit Journal* of, says country is tired of present chamber of deputies and will elect new members.—Sept. 19.
- Paris, at meeting of M. Thiebaud's supporters great conflict with Boulangists.—Sept. 19.
- Paris, Sunday observance committee advise manufacturers to give employees a weekly holiday when Sunday one is impossible.—Sept. 27.
- Republicans nominate M. Thiebaud as candidate for Chamber of Deputies in Montmartre.—Sept. 13.
- Thirty-two Boulangist candidates withdraw.—Sept. 20.
- Tribunal of the Seine orders directors of Comptoir D'Escompte to refund sums claimed by shareholders.—Sept. 17.
- Thevenet, Minister of Justice, issues circular reminding bishops and clergy of prohibition against ecclesiastical interference in elections.—Sept. 6.
- GERMANY, Alsace-Lorraine. Three French citizens expelled.—Sept. 5.
- Empress Augusta Victoria joins Catholic church.—Sept. 4.
- Emperor and Empress arrive at Dresden.—Sept. 6.
- Emperor William authorizes loan of \$1,000,000 marks for establishment of new army corps in Alsace-Lorraine.—Sept. 15.
- Leaders of German party in Bohemia decline to join Czechs conferences at Vienna.—Sept. 18.
- Emperor William subscribes 10,000 francs for relief of Antwerp sufferers.—Sept. 21.
- Emperor William instructs Minister of Justice to report on execution by electricity.—Sept. 28.
- Government decide that no retaliatory measures shall be taken for increase of Russian duties.—S. pt. 25.
- Twenty-seventh anniversary of Prince Bismarck's appointment as President of Prussian Cabinet.—Sept. 24.
- Gooderham Millionaire, of Toronto, bequeaths his fortune to charitable institutions.—Sept. 19.
- Gladstone Mr. W. E., arrives in Paris.—Sept. 2.
- Gladstone Mr. W. E., disapproves Catholic University scheme as impracticable.—Sept. 4.
- Gold discovered at Princes Ledge near Halifax.—Sept. 6.
- Gold discovered in Tacoma, Washington Territory.—Sept. 26.
- Grant, Fort Leavenworth, Kan., statue of Gen. Grant unveiled.—Sept. 14.
- Halifax, dry dock opened by Vice-Admiral Watson.—Sept. 19.
- Hayti, Ex-President Legitime arrives at New York en route to Paris.—Sept. 5.
- High tides reported at Atlantic and Seaside cities, N. J., cause great havoc and death.—Sept. 8.
- Hokendaga, Pa., stockholders of Thomas Iron Co. sell works to English syndicate for \$3,500,000.—Sept. 10.
- Holland, Parliament opens, King in speech promises modification of Customs tariff.—Sept. 17.
- Hot Springs in Yellowstone Park explode.—Sept. 11.
- Humphreys Islands and Kyerson Island annexed by H. M. S. "Espiegle." Reported.—Sept. 6.
- Immigration, Montreal, fifteen Chinamen on S.S. "Haverton" landed at.—Sept. 9.
- Imperial Federation, Vancouver, B.C., branch of Imperial Federation League formed at.—Sept. 14.
- IRELAND, Catholic University scheme disapproved by Mr. Gladstone as impracticable.—Sept. 4.
- Balfour denies statement in Gladstone's letter that Conybeare, M. P., is suffering from disease in prison.—Sept. 12.
- Balfour, in letter to sect. of Protestant Alliance, states that in his opinion the endowment of a Catholic University in, is not necessary.—Sept. 23.
- Davitt protests against acceptance by Home Rule party of Catholic University scheme, that being a proper subject for an Irish Parliament to legislate upon.—Sept. 2.
- Dublin, Mr. Sullivan denounces Balfour University scheme.—Sept. 10.
- Dublin, Redmond, M. P., nationalist, arrested at, for conspiracy.—Sept. 17.
- Dublin, Father O'Dwyer sentenced to five months imprisonment for Crimes Act infringement.—Sept. 18.
- Dublin, Lord Mayor of, in speech, declares that in spite of Balfour's proposed remedial intentions towards Ireland, that such people must have their own parliament.—Sept. 19.
- Dungannon, Ireland, meeting of English Liberals proclaimed by police.—Sept. 20.

## IRELAND.—Continued.

- English Home Rule deputation on tour through, great meeting at Mallow.—Sept. 15.
- Emigration, 78,084 immigrated from past year.—Sept. 6.
- Failure of north of Ireland mackerel fishery.—Sept. 3.
- Harlington Lord, speaking at Bradford, disavows the fustian of the Conservative Liberal Unions, parties except on the Home Rule programme.—Sept. 7.
- Kennaree estates, controversy with tenants amicably settled by cancellation of arrears of rent.—Sept. 5.
- Kingston, Irish Catholic Benevolent Association, after addresses by Archbishop Cleary and others, wire resolutions of sympathy to Mr. Parnell.—Sept. 6.
- Cork, O'Brien Wm., sent to Galway Gaol.—Sept. 2.
- O'Brien Wm., seriously ill in Galway Gaol.—Sept. 3.
- R. C. Champsains of prisons in, combine to claim exemption from prison rules.—Sept. 26.
- Branches of National League in Co. of Waterford and Tipperary suppressed.—Sept. 27.
- Parnell fund closes with £10,000.—Sept. 30.
- Redmond W. H. K., M. P., convicted for offences under Crimes Act, and sentenced to 3 years imprisonment.—Sept. 21.
- Indiana, Count d'Adieu Indians sell 250,000 acres of their preservation to U. S. Government for \$500,000.—Sept. 20.
- Indiana, Standing Rock, Dak. Sitting Bull in danger. Indians holding him responsible for sickness of John Grass, Chief Justice of the Sioux.—Sept. 6.
- Italy, address presented to Signor Crispi at Naples, by 20,000 persons.—Sept. 20.
- Japan, great floods reported in, enormous loss of life, 10,000 drowned.—Sept. 19.
- JESUIT ESTATES QUESTION.—Quebec, at meeting of Protestant Council of Public Instruction, Prof. Shaw moves that \$50,000 granted to Protestant Education be accepted, provided entire sum not interest alone be given.—Sept. 25.
- Equal Rights Association, of, meet and protest against grant of \$60,000.—Sept. 26.
- Privy Council grants an appeal to Protestant Educational Commissioners.—Sept. 24.
- Jesuit Estates Act, Law Officers of the Crown in England report Act in their opinion constitutional and no case to submit to Privy Council.—Sept. 1.
- Joggins Raft, Canada *Gazette* announces incorporation of Joggins Raft Co., with capital of \$100,000.—Sept. 21.
- Journalistic, Chicago, reported that *Times* of, will pass into Mr. W. H. Smith's hands.—Sept. 23.
- Journalistic, Montreal, sale of *Le Canadien* and *Cultivateur* to Mr. Tarte, announced.—S. pt. 25.
- Journalistic, New York *Daily Graphic* suspended publication.—Sept. 24.
- Journalistic, Toronto, publication of the *Bystander* resumed.—Sept. 27.
- LABOR, Congress, Montreal, Land question discussed.—Sept. 5.
- Labor Congress, Montreal, condemns manual training system proposed by Ontario Minister of Education.—Sept. 5.
- Labor Knights of, Dominion Trades and Labor Congress, session at Montreal, opened by Ald. Rolland.—Sept. 3.
- Labor, eight cotton mills in Preston and fourteen in Blackburn shut down.—Sept. 29.
- Quebec, all city corporation workmen discharged.—Sept. 10.
- LEGAL, British Columbia, appointments in, Vale district, W. W. Spinks, New Westminster, W. N. Role, Cariboo, Hon. C. F. Cornwall.—Sept. 19.
- Ottawa, Chas. McGee, administrator of Sparks Estate, enters suit in Exchequer Court ex. Government to recover \$100,000 worth of property.—Sept. 26.
- Montreal, Judge Taite orders nuns of Hotel Dieu to appear in court as witnesses.—Sept. 21.
- Montreal, Superior Court of, awards \$12,000 damages to Messrs. Murray and Rankin against the G.T.R.—Sept. 23.
- Montreal, Jesuits, *Mail* case, the *Mail's* appeal in Jesuit libel suit from Judge Loranger's decision brought before Court of Appeals in.—Sept. 26.
- Montreal, Jesuit *Mail* case, argument opened, Hon. Mr. Laflamme, Q. C. for *Mail*, contends that Jesuits' body is civilly dead, etc., etc.—Sept. 26.
- Montreal, Jesuits *Mail* case, appellants' argument concluded.—Sept. 27.
- Literary, Mr. Gladstone presents free library to town of Hawarden.—Sept. 18.
- London, Lord Mayor Isaacs elected for ensuing year.—Sept. 28.
- London, police of, raid Cranbourne Club.—Sept. 21.

- meeting at
- tion of the  
the Rule pre-  
ceded by con-  
addresses by  
sympathy to
- emption from  
d Tipperary
- Crimes Act,
- reservation to
- ians holding  
justice of the
- 00 persons.—  
0 drowned.—
- f Protestant  
(the \$50,000  
d entire sum
- grant of \$50,-  
000.
- Commission-  
report Act in  
Privy Council.
- Juggins haft  
to Mr. W. H.  
r to Mr. Tarte,
- n.—Sept. 24.  
t.—Sept. 27.
5.  
stem proposed
- ess, session of,
- Blackburn shut
- 4, 10.
- W Spinks, New  
all.—Sept. 19.
- enters suit in  
worth of prop-
- appear in court
- ges to Messrs.
- libel suit from  
Appeals in.—
- Mr. Laflamme,  
end, etc., etc.—
- cluded.—Sept.
- f Hawardec.—
- 28.
- Louisiana, unauthorized bonds of State of Louisiana, to extent of \$850,000, placed on market.—Sept. 19.
- Louisiana, Ex-State Treasurer of, found short in his accounts to amount of \$12,000,000.—Sept. 28.
- Louisville, Ky., American Humane S. cety opens annual Convention.—Sept. 26.
- Macdonald Sir John, unveils statue of Col. Williams at Fort Hope.—Sept. 5.
- Macdonald Sir John, receives handsome present from Lord Lansdowne, Viceroy of India.—Sept. 23.
- Mackenzie Sir Mowat, presented with freedom of City of San Lorenzo.—Sept. 18.
- Magdalen Island's, great drought terminated.—Sept. 17.
- Manitoba, Daniel McLean, M.P. for Dennis, appointed Minister of Education.—Sept. 10.
- Manitoba, *Le Manitoba* appeals to French voters in Dennis to vote for Mr. R. Campbell.—Sept. 25.
- MARRIAGES, London, Chamberlain Miss Jeanie, of Cleveland, Ohio, to Captain Leyland.—Sept. 5.
- Projected match between Prince Hatzfeldt and Miss Huntingdon broken off.—Sept. 17.
- Marine, New York, Royal Arch of Scotland holds its annual session at.—Sept. 15.
- Marine, Supreme Council of Scottish Rite close first session at New York.—Sept. 10.
- Masonic, New York, General Masonic Relief Association of U. S. and Canada closes annual session at, 800 cases of fraud discovered during past 3 years.—Sept. 9.
- Maybrick children adopted by wealthy couple in Lon-Don.—Sept. 4.
- MEDICAL, Newcastle, Eng., at conference of British Pharmaceutical Association, Professor Steebold shows presence of arsenic in glycerine.—Sept. 11.
- Quebec, semi-annual meeting of Board of Governors of College of Physicians meet.—Sept. 25.
- St. Hyacinthe, P.Q., Canada, medical practitioners of, form Chirurgical Society.—Sept. 24.
- Result of ballots for Manitoba Council of Physicians and Surgeons.—Sept. 21.
- Mexico, anniversary of Independence celebrated.—Sept. 16.
- Mexico, great waterspout bursts, killing several persons.—Sept. 19.
- MILITARY, Dominion Rifle Assn., Governor General's prize won by Private Burns of Victoria Rifles, Montreal.—Sept. 6.
- Austria, Archduke Frederick appointed to command of fifth army corps of.—Sept. 17.
- Cairo, enteric fever appears in the garrison at.—Sept. 17.
- England, Major General Grenfell arrives in England from Cairo.—Sept. 18.
- France, Germany, Austria, Italy and Russia hold grand autumn manoeuvres.—Sept. 24.
- Germany, reported that new army of, will cost \$200,000,000 marks.—Sept. 9.
- Hanover, new smokeless gun powder successfully tried in sham fight at.—Sept. 21.
- Italy, Government of, order Kuupp masked towers for defence of Alps.—Sept. 23.
- Kingston, Que., Hamilton, F Battery, win firing exercises at, with 218 points.—Sept. 25.
- Kingston, Ont., results of Field Artillery, competition made known 1st Montreal, 200 points.—Sept. 27.
- Leige, Bulgarian Government place orders at, for 33,000 Berdan rifles and 2,000,000 cartridges.—Sept. 8.
- Montreal, Guelph cadets visit.—Sept. 26.
- Munich, 135 men disabled by sunstroke during military manoeuvres.—Sept. 6.
- Ottawa, Major Todd declines colonelcy of Governor General's foot guards.—Sept. 19.
- Paris, Minister of war inspects sixth army corps.—Sept. 19.
- Quebec, Artillery competition opens at Isle of Orleans.—Sept. 10.
- Rubtak, India, great religious riot at, many killed.—Sept. 11.
- Russia, large forces of, army massed in Armenia.—Sept. 9.
- Serbia, reserve forces disbanded.—Sept. 13.
- Trinidad, mutiny amongst troops at, 24 killed.—Sept. 11.
- Turkey, 100,000 Mauser repeating rifles ordered to be ready in a month.—Sept. 5.
- Minnesota, 4,000,000 acres in, opened for settlement.—Sept. 13.
- Missions, Toronto, four Presbyterian missionaries leave for China.—Sept. 23.
- Mormonism, Report of U. S. Commission on subject of Mormonism given, strongly condemning the evil.—Sept. 27.
- MURDERS.—Greenwood, Miss., twenty two negroes resisting arrest killed by shooting.—Sept. 2.
- Brooklyn, millionaire F. W. Geeseven, shot in his office by an old man.—Sept. 13.
- Chicago, Cronin trial, defendants' lawyers quarrel amongst themselves.—Sept. 9.
- Chicago, Cronin, Glan-na-Gael man tells reporter at Peoria, that Irish Republican Brotherhood had condemned Danne and Meahan to death as well as Dr. Cronin.—Sept. 9.
- Chicago, Cronin, second week of, trial closes, 20 Jurors accepted.—Sept. 11.
- Chicago, Cronin, more testimony against Beggs and Coughlin, Kelly discloses what he knows concerning plot.—Sept. 16.
- Chicago, Cronin, greatest sensation yet created by bringing to light the scheme to place a bogus body in the Thames.—Sept. 17.
- Chicago, Cronin trial, four Jurors obtained, Le Caron again in Chicago.—Sept. 18.
- Chicago, Cronin trial, local paper prints sensational story regarding Dr. Cronin's death.—Sept. 12.
- Hamilton, Ont., policeman shoots unknown man in boarding house at.—Sept. 26.
- Harrison, N. J., body of Italian found in pit terribly mutilated.—Sept. 9.
- London, Eng., Cable Sheet, Whitechapel, another body of an unfortunate found, supposed to be victim of Jack the Ripper.—Sept. 10.
- London, Whitechapel murder reported 2 days before its occurrence by one Cleary.—Sept. 10.
- Montpelier, Vt., Sherman Cartwell shot Willard Cutter, in a fit of jealousy.—Sept. 4.
- Montreal, Châbler A Atholite, an unfortunate, murdered by some person unknown.—Sept. 5.
- Pensacola, Fla., Policeman Fairchild shot by D. Sheenan at.—Sept. 23.
- NAVAL, Philadelphia, U.S., cruiser "Philadelphia" launched at.—Sept. 8.
- Quebec, court martial on Lieutenant held on board H.M.S. "Bellerophon," 17 men desert.—Sept. 9.
- San Francisco Judge Swyers, of U.S. Circuit Court, discharges Marshal Nagle, murderer of Judge Terry, with bonds of \$5,000.—Sept. 15.
- Hull, Eng., Sir M. Hicks Beach, in speech, advocates creation of stronger British Naval reserve.—Sept. 19.
- Halifax, H. M. S. "Pythodes" and "Emerald" sent to scene of wreck of "Lily."—Sept. 22.
- Negroes, twenty-two killed by white "regulators" at Laurel Co., Miss.—Sept. 1.
- Negro Problem, Charleston, S.C., Negroes through their organ *Plain Speaker* protest against proposed deportation of colored men to Mexico.—Sept. 19.
- Negroes, Tool Co., Ky., blacks of, organize Stock Co., with capital of \$25,000.—Sept. 23.
- New Brunswick, St. John, N.B., proposed dissolution of Assembly opposed by county members supporting Government.—Sept. 24.
- New York, stockholders of Thomas Iron Co., refuse offer of \$5,500,000 from English syndicate for their work.—Sept. 15.
- New York, Mayor of, issues address to Mayors of U. S. cities, asking aid for coming International Exhibition in.—Sept. 13.
- Niagara Falls, S. Brodie arrested for going over falls in barrel, placed under \$500 bonds.—Sept. 7.
- Niagara, C. D. Graham reported to have gone over the falls in a barrel.—Sept. 1.
- Niagara Falls, Walter Campbell swims through whirlpool rapids.—Sept. 15.
- North West, Lord Stanley in speech at Winnipeg prophesies great future for.—Sept. 24.
- Nova Scotia, great wind storm sweeps over, causing much damage.—Sept. 19.
- Orientalist Congress opened at Stockholm by King Oscar.—Sept. 2.
- Ottawa, new U.S. consul, R. E. Lay, arrives at.—Sept. 13.
- Pugilism, St. Louis, T. E. Jackson killed by E. Abern in prize fight.—Sept. 16.
- Quebec, Province of, Pierre Ayotte, proprietor of *Trifurcien*, committed for publishing seditious article concerning the administration of law.—Sept. 5.
- QUÉBEC, official *Gazette* announces composition of new council of agriculture and Arts and Manufactures.—Sept. 8.
- Annexation of St. Suvreur to city confirmed.—Sept. 27.
- Catholic Board of Public Instruction decide to reduce grant to classical colleges, by 10 per cent.—Sept. 26.
- Citizens Ball to Lord and Lady Stanley.—Sept. 10.
- Premier Mercier asks French to unite for common welfare.—Sept. 13.

- RAILWAYS, C. P. and N. R.R.** announce sweeping reduction in rates from Chicago to St. Paul.—Sept. 13.
- C.P.R. lets contract for 709 miles of new road in North-West.—Sept. 11.
- Concord R.R. stockholders of, ratify consolidation with Boston, Concord and Montreal R.R.—Sept. 10.
- Duluth, S. Shore R.R. announce biggest cut in Eastern passenger rates of season.—Sept. 10.
- Eastern R. Roads declare to arrange with the Freight Association for tariff between seaboard and St. Paul.—Sept. 10.
- G.T.R. issue orders for laying of double track between Hamilton and Toronto.—Sept. 24.
- Grand Trunk, rumor that G.T.R. will connect Halifax and St. John, circulated.—Sept. 30.
- Hamilton, Ont., Finance Committee appoint deputation to oppose request of G.T.R. to construct spur line connecting old Northern and N.W.R.R. and G.T.R. running East.—Sept. 23.
- Mackey Syndicate reported to have purchased C.W. and M.R.R. price of controlling interest \$1,717,000.—Sept. 12.
- Montreal, Mr. T. G. Shaughnessy appointed assistant president of C.P.R.—Sept. 8.
- Michigan Central and Grand Trunk R. R. clerks ordered to reside at Detroit.—Sept. 28.
- Missouri, Pacific, Ex-Pres. Strong accepts presidency of Missouri Pacific R.R. Co.—Sept. 26.
- New financial scheme of N. P. R.R. provides for a blanket mortgage of \$160,000,000.—Sept. 17.
- Ohio, Neb., reported at, that employees of Union Pacific and labor organizations have formed into Brotherhood of R. R. employees.—Sept. 19.
- Paris, R.R. Congress selling at, recommend hard steel for rail purposes.—Sept. 22.
- Plans for Toronto, Hamilton and Buffalo R.R. registered.—Sept. 25.
- Quebec Central R.R. apply for further extension of 3 years to complete line to Maine boardary.—Sept. 22.
- Quebec, Chambre de Commerce approve of South Shore R.R. scheme.—Sept. 24.
- Rail for the first 50 miles of the G. N. W. R.R. unloaded at Montreal.—Sept. 18.
- Siox City, Ia., offices of S. C. and N. R. R., agree for transfer of freight with M.P. and Manitow companies.—Sept. 27.
- Thompson's Springs, Denver and Rio Grande train robbed.—Sept. 24.
- Titchburg R. R. slow 34 per cent. earned in stock for year ending Sept. 30.—Sept. 13.
- Toronto, rumor that N. C. R. R. bought by C.P.R.—Sept. 11.
- Toronto, mail clerks of Canada R.R. meet at, to organize society.—Sept. 12.
- Richmond County, Exhibition opened.—Sept. 26.
- Riot, Park Co., Minn., in factional fight between French and German Catholics, Church of St. Joseph burnt by former.—Sept. 23.
- Riot, Wilmington, Del., race riot between Irishmen, Poles, and Slaves, Francis J. R. Jankovisky a Hungarian shot dead, an Irishman, Owen Kavanagh, stabbed.—Sept. 7.
- Rockaway Beach, unexpected tidal wave causes great destruction at.—Sept.
- Rockwood, Autumn show, opened by Lord Lansdowne.—Sept. 26.
- RUSSIA, Czar** approves of increase of Eastern R.R. rolling stock.—Sept. 11.
- Entire Bench of Riga judges arrested for using German language.—Sept. 10.
- Gov. prohibit purchase of cattle by German traders, with German money.—Sept. 13.
- Twenty students arrested as Nihilists at Rieff, Russia.—Sept. 20.
- Reported that Government's receipts for fiscal year 1889 exceeded expenditure by 30,000,000 roubles.—Sept. 23.
- Chief of general staff of, advocates laying of railway on Western frontier.—Sept. 29.
- S. Louis, C. R. Pope, new English consul, arrives at.**—Sept. 23.
- SAMOA, Ring, Malietoa restored to power.**—Sept. 15.
- Science, American Association for advancement of, closed convention at Toronto.**—Sept. 3.
- Scotland, scheme announced for construction of canal between Edinburgh and Glasgow, capital £7,000,000.**—Sept. 11.
- BARNIA Queen Nathalie** warned by Regents not to attempt to establish residence at Belgrade.—Sept. 5.
- Mr. McDonal, British vice-consul at Neisch, arrested in Westaken for brigand.—Sept. 12.
- Odessa, ex-Queen Nathalie, of Servia, officially received at.—Sept. 17.
- M. Christich dismissed from the diplomatic service, by Servian Government.—Sept. 20.
- Odessa, ex-Queen Nathalie, departs for Belgrade.—Sept. 20.
- SHIPPING, Lewis, Del., schooner "W. O. Snow" lost in great gale with crew.**—Sept. 12.
- Allan S.S. Co. refuse to tender for new Canadian mail contract.—Sept. 23.
- Auckland, N.Y., S.S. "Waeani" covers Capt. and crew of foundered British S.S. "Garston" to.—Sept. 15.
- British S.S. "Vertumnus" wrecked off Point Lookout, L.I.—Sept. 17.
- Cape Vincent, collector of Customs denies that Thousand I. S.S. Co. have violated contract labor laws.—Sept. 26.
- Capt. Smith reports stranding of S.S. "Montreal" to be accidental.—Sept. 14.
- Chatham, N.B., collector of Customs seizes Glasgow schooner "Delhi".—Sept. 15.
- Cleveland, Ohio, three bodies recovered from wreck of steam yacht "Leo".—Sept. 19.
- Liverpool, municipal authorities of vote £30,000 to erect depots for storage of petroleum.—Sept. 13.
- Morocco, Spanish vessel plundered by natives off coast of.—Sept. 17.
- New York, S.S. "Teutonic" and "City of New York" start on Ocean race from.—Sept. 18.
- Prescott, S.S. "Rothesay" collides with tug "Moira," ten men drowned.—Sept. 11.
- S.S. "Etruria" makes passage from Queenstown to New York in days, 1 hr.—Sept. 8.
- Queenstown, Ireland, S.S. "Teutonic" arrives at, from New York, making passage in 6 days 8 hours.—Sept. 24.
- Washington, Capt. of "D. A. Small" accused of terrible cruelties to his men.—Sept. 11.
- Slavery, Cardinal Laviger** proposes formation of Independent National Committee on slavery question.—Sept. 14.
- Slavery, English and Italian Government** sign anti-slavery convention.—Sept. 18.
- Smuggling, Mr. Cornellier, Q.C., appointed by Canadian Government to investigate smuggling of American whiskey into Canada.**—Sept. 25.
- Snow on Mt. Washington.—Sept. 19.
- Socialism, Chicago, Socialist convention takes place at.—Sept. 29.
- SPORTS**—Aquatic, London, Thames, Searl Henry G., Australian champion, beats O'Connor William, in sculling match for championship of world.—Sept. 7.
- Aquatic, London, Searle defeats O'Connor on Thames course.—Sept. 9.
- Aquatic, London, Searl offers to row O'Connor again for £1,000.—Sept. 12.
- Aquatic, St. Johns, first Regatta of St. Johns Yacht Club held.—Sept. 7.
- Aquatic, Pt. Claire, P.Q., "Minnie A." defeats "Lula" in open sailing race at, and wins Vice-Commodore's cup.—Sept. 14.
- Athletics, one hundred entries made for annual meeting of Athletic Association of Canada.—Sept. 25.
- Baseball, Montreal, Cornwall defeated by, at, five to two.—Sept. 21.
- Baseball, Montreal, Shamrocks defeat Ottawa four to three.—Sept. 14.
- Lacrosse, Montreal, Shamrocks Toronto team at.—Sept. 7.
- Lacrosse, Montreal, Shamrocks defeat Torontos, at, four to two.—Sept. 28.
- Lacrosse, Ottawa, Cornwall defeats, 3 games to one.—Sept. 7.
- Montreal, Autumn season of M. Hunt Club opens.—Sept. 4.
- Racing, Montreal, Belair Jockey Club hold Autumn meeting.—Sept. 24.
- Racing, Montreal, second day of Belair Jockey Club, Autumn meeting.—Sept. 26.
- Racing, St. Ledger stakes won by "Donovan," "Miguel" second.—Sept. 10.
- Racing, England, Portland, plate won by "Galloping Queen"—Sept. 13.
- Scullion, Montreal, O'Connor arrives from England.—Sept. 30.
- Shooting, Ottawa, the Macdougall match and the Gizowski Cup and British Challenge Shield, shot fur.—Sept. 2.
- Shooting, Ottawa, Canada Dominion of, Rifle Match.—Sept. 4.
- Stooley Lord and Lady, leave Ottawa for Manitoba.—Sept. 18.
- STANLEY H. M., Marches towards Mamtaza after fighting unfriendly tribes.**—Sept. 11.
- Reported failure of, to make headway west of Lake Victoria, Nyanza.—Sept. 12.
- STORMS, Atlantic City, great gale still continuing at, great damage done.**—Sept. 12.
- New York, very high tide rises, storm causes much havoc in.—Sept. 10.
- New York, terrible accounts of wreckage and loss of life, result of great late storm, reported at.—Sept. 15.

## STORMS.—Continued.

New York, reported that oyster planters of, sustain loss of \$2,000,000 by late storm.—Sept. 16.  
 East Coast, immense damage done all along east Coast by tides. Number of vessels ashore, summer resorts suffer severely.—Sept. 11.  
 Thirty vessels reported wrecked ashore, etc., on East Coast, during storm.—Sept. 12.  
 Pablo Beach tornado passes over, causing great damage.—Sept. 23.  
 Valley Falls, Kan., heaviest rain storm for year occurs, railways damaged, 3 persons drowned.—Sept. 15.  
 Atlantic City, high tide breaks into dozen buildings, causing terrible stampede for life.—Sept. 12.

## STRIKES.—London dock laborers, great demonstration in Hyde Park.—Sept. 1.

Bibb Co., Ala., Negroes of, refuse to work for whites.—Sept. 21.  
 Blackburn, Eng., employees in five cotton mills resume work.—Sept. 1.  
 Dockmen, Liverpool, Eng., men employed on Grain and Flour laden ships strike for increase of one shilling per week.—Sept. 3.  
 Gall, Ont., strikers in moulding shop of McGregor & Co. destroy boxes of moulding.—Sept. 12.  
 London Dockyard strikers compel men working at Albert Dock to cease work.—Sept. 2.  
 London, Burns to contest Dundee as labor candidate.—Sept. 6.  
 London, Dock laborers resolve to continue, new terms proposed.—Sept. 8.  
 London, several companies express willingness to accede to employees' demands.—Sept. 9.  
 London, Dock companies refuse to depart from terms offered to strikers.—Sept. 9.  
 London, strikers resume work at advanced wages on 35 wharves.—Sept. 9.  
 London, strikers meet, John Burns denounces organized workingmen of America.—Sept. 10.  
 London, Cardinal Manning's proposals for settlement considered by companies, Burns again addresses his followers.—Sept. 10.  
 London, Dock directors discuss payment of heavier dues, and shipment of dockmen by shippers.—Sept. 11.  
 London, John Burns ill, strikers still resolute.—Sept. 11.  
 London, Dock strike over, directors of companies accept Card. Manning's compromise.—Sept. 12.  
 London, Lord Mayor states men will resume work on Monday.—Sept. 13.  
 London, New Zealand Shipping Co. bring action against Dock Companies of, for detention of mail S.S. "Ruapehu."—Sept. 9.  
 London, dock laborers resume work.—Sept. 14.  
 London, Burns and Tillett sign agreement, settling dock strike.—Sept. 15.  
 London, severe encounters between strikers and blacklegs.—Sept. 16.  
 London, conference between Cardinal Manning, Lord Mayor, and Dock directors on attitude of strikers.—Sept. 18.  
 London, Lord Brassey consents to act as arbitrator in matter of lightermen's grievances.—Sept. 19.  
 London, stevedores of E. India Docks strike again.—Sept. 23.  
 London, stevedores of E. India Docks resume work.—Sept. 25.  
 25.  
 New York, reported at International Cigarmakers Convention at, that during past ten years 109 strikes occurred in trade.—Sept. 21.  
 Pennsylvania coal miners return to work.—Sept. 14.

## STRIKES.—Continued.

Pittsburg, Pa., Allegheny Bessemer Steel Works at, five hundred men strike against new scale of firm.—Sept. 2.  
 Quebec, Navies on Baie des Chaleurs R.R. cease to work for arrears in pay.—Sept. 21.  
 Rotterdam, of Dock laborers.—Sept. 26.  
 Windsor, Ont., an unknown man and woman commit suicide.—Sept. 20.  
 SUICIDE.—Coburg, Ont., John Emerson in gaol on charge of forgery hangs himself.—Sept. 1.  
 Constantinople, Van Hass, director of Ottoman bank of, kills himself.—Sept. 11.  
 France, three sisters ruined by Panama Canal failure.—Sept. 6.  
 New York, Pettey Mrs. Kate, saturated her clothing with oil, drank a pint of it, and set herself on fire.—Sept. 5.  
 Niagara Falls, Brodie Steve, put under bail for attempting to commit by swimming Falls.—Sept. 7.  
 Odessa, teacher of, commits suicide, his wife kills her five children and herself.—Sept. 26.  
 Swift Current, Manitoba, remarkable meteor seen at.—Sept. 26.  
 TELEGRAPH.—Connecting Canadian Pacific with Mackay-Bennett cable system.—Sept. 5.  
 Western Union rates between New York, Boston and Philadelphia advanced.—Sept. 1.  
 Western Union Telegraph Co. declare dividend of 1½ per cent. revenue for quarter \$1,750,000.—Sept. 11.  
 Telephone stations in Paris seized by Government.—Sept. 2.  
 Remington Paper Co.'s Mills, Watertown, N.Y., sold to German syndicate for \$1,800,000.—Sept. 2.  
 Toronto, ex-Mayor Manning buys Brewing and Malting Co. of, for \$150,000.—Sept. 14.  
 Triple Alliance, Rore Blind, socialist in *Reformer* of Rome, declares that maintenance of triple alliance is necessary for peace of Europe.—Sept. 19.  
 Turkey, Sultan orders meeting of Cabinet to suppress disorders in Armenia.—Sept. 9.  
 Turkey, *Budget* to be equalized.—Sept. 27.  
 Vaccination, twenty-seven passengers from S.S. "Circassian" landed at Grosse Isle, Que., for non-compliance with quarantine vaccination regulations.—Sept. 14.  
 Warner General declines President's tender of commissionership of pensions.—Sept. 18.  
 Williams Colonel, statue at Port Hope, unveiled by Sir John Macdonald.—Sept. 5.  
 Wills, Montreal, rev. Abbe Rousselot leaves large fortune to numerous R.C. Institutions.—Sept. 23.  
 Winn'peg, Governor General received at.—Sept. 23.  
 World's Fair, New York Committee offers \$20,000 prize for plan of five principal buildings.—Sept. 6.  
 World's Fair, Chicago, Executive Committee of, decide to increase capita stock to \$10,000,000.—Sept. 13.  
 World's Fair, New York, site for, chosen.—Sept. 20.  
 Wyoming Valley, Va., great land cave in occurs, affecting 30 acres, 1,500 men thrown out of employment.—Sept. 11.  
 Wyoming, State Convention, adopts female suffrage clause.—Sept. 1.

NEW YORK STOCK MARKET CLOSING QUOTATIONS.

SEPTEMBER.

	Tuesday 3	Wednesday 4	Thursday 5	Friday 6	Saturday 7	Monday 9	Tuesday 10	Wednesday 11	Thursday 12	Friday 13	Saturday 14	Monday 16	Tuesday 17	Wednesday 18	Thursday 19	Friday 20	Saturday 21	Monday 23	Tuesday 24	Wednesday 25	Thursday 26	Friday 27	Saturday 28	Monday 30	
Canadian Pac.....	76	74	75	75	74	74	74	75	75	75	74	74	74	74	74	74	74	74	74	74	74	74	74	74	74
C. C. & I.....	192	188	188	188	188	188	188	188	188	188	188	188	188	188	188	188	188	188	188	188	188	188	188	188	188
C. H. V. & T.....	54	54	54	54	54	54	54	54	54	54	54	54	54	54	54	54	54	54	54	54	54	54	54	54	54
Canada Southern.....	106	106	106	106	106	106	106	106	106	106	106	106	106	106	106	106	106	106	106	106	106	106	106	106	106
C. B. & O.....	130	130	130	130	130	130	130	130	130	130	130	130	130	130	130	130	130	130	130	130	130	130	130	130	130
C. & Hudson.....	28	28	28	28	28	28	28	28	28	28	28	28	28	28	28	28	28	28	28	28	28	28	28	28	28
Lehigh Valley.....	103	104	104	104	104	104	104	104	104	104	104	104	104	104	104	104	104	104	104	104	104	104	104	104	104
do seconds.....	68	68	68	68	68	68	68	68	68	68	68	68	68	68	68	68	68	68	68	68	68	68	68	68	68
Eric preferred.....	124	124	124	124	124	124	124	124	124	124	124	124	124	124	124	124	124	124	124	124	124	124	124	124	124
Kan. & Texas.....	104	104	104	104	104	104	104	104	104	104	104	104	104	104	104	104	104	104	104	104	104	104	104	104	104
Lake Shore.....	74	74	74	74	74	74	74	74	74	74	74	74	74	74	74	74	74	74	74	74	74	74	74	74	74
Mo. & N. W.....	74	74	74	74	74	74	74	74	74	74	74	74	74	74	74	74	74	74	74	74	74	74	74	74	74
Missouri Pacific.....	74	74	74	74	74	74	74	74	74	74	74	74	74	74	74	74	74	74	74	74	74	74	74	74	74
N. J. Central.....	74	74	74	74	74	74	74	74	74	74	74	74	74	74	74	74	74	74	74	74	74	74	74	74	74
Northern Pac.....	74	74	74	74	74	74	74	74	74	74	74	74	74	74	74	74	74	74	74	74	74	74	74	74	74
do preferred.....	74	74	74	74	74	74	74	74	74	74	74	74	74	74	74	74	74	74	74	74	74	74	74	74	74
Northwestern.....	74	74	74	74	74	74	74	74	74	74	74	74	74	74	74	74	74	74	74	74	74	74	74	74	74
N. York & N. E.....	74	74	74	74	74	74	74	74	74	74	74	74	74	74	74	74	74	74	74	74	74	74	74	74	74
do preferred.....	74	74	74	74	74	74	74	74	74	74	74	74	74	74	74	74	74	74	74	74	74	74	74	74	74
Omaha.....	51	51	51	51	51	51	51	51	51	51	51	51	51	51	51	51	51	51	51	51	51	51	51	51	51
do preferred.....	100	100	100	100	100	100	100	100	100	100	100	100	100	100	100	100	100	100	100	100	100	100	100	100	100
Atch. & Topeka.....	38	38	38	38	38	38	38	38	38	38	38	38	38	38	38	38	38	38	38	38	38	38	38	38	38
Oregon Trans.....	38	38	38	38	38	38	38	38	38	38	38	38	38	38	38	38	38	38	38	38	38	38	38	38	38
Pacific Mail.....	38	38	38	38	38	38	38	38	38	38	38	38	38	38	38	38	38	38	38	38	38	38	38	38	38
Rock Island.....	47	47	47	47	47	47	47	47	47	47	47	47	47	47	47	47	47	47	47	47	47	47	47	47	47
R. T.....	23	23	23	23	23	23	23	23	23	23	23	23	23	23	23	23	23	23	23	23	23	23	23	23	23
St. Paul.....	64	64	64	64	64	64	64	64	64	64	64	64	64	64	64	64	64	64	64	64	64	64	64	64	64
Texas Pac.....	64	64	64	64	64	64	64	64	64	64	64	64	64	64	64	64	64	64	64	64	64	64	64	64	64
Union Pac.....	172	172	172	172	172	172	172	172	172	172	172	172	172	172	172	172	172	172	172	172	172	172	172	172	172
Wausau.....	86	86	86	86	86	86	86	86	86	86	86	86	86	86	86	86	86	86	86	86	86	86	86	86	86
Western Union.....	86	86	86	86	86	86	86	86	86	86	86	86	86	86	86	86	86	86	86	86	86	86	86	86	86

John  
GA  
COURT  
Subser  
EACH  
The  
from ot  
cities, t  
rivers,  
Mo

# Photo - Engraving.

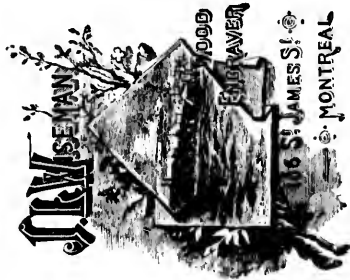

# Pen Drawing & Map Etching.

John Lovell, publisher of the Dominion Directory in 1871, at a cost of over \$80,000, now issues the

## PROSPECTUS OF LOVELL'S GAZETTEER AND HISTORY

OF EVERY COUNTY, DISTRICT, PARISH, CITY, TOWNSHIP, TOWN, VILLAGE, ISLAND, LAKE AND RIVER

IN THE EIGHT PROVINCES OF THE DOMINION OF CANADA. IN ELEVEN VOLUMES.

Subscription to the Eleven Volumes, bound in full cloth, Gilt.....	\$57 00
" Ontario or Quebec, 2 Vols. each, with a Map.....	12 50
" New Brunswick or Nova Scotia, with a Map.....	11 50
" Manitoba or British Columbia, with a Map.....	9 50
" Prince Edward Island or Northwest Territories, with a Map.....	9 50
" Eleventh Volume. It will contain a concise History of the Dominion of Canada, Eight Beautiful Maps, List of Lakes, Rivers, Post Offices, &c.....	20 05

**EACH PROVINCE, ALPHABETICALLY ARRANGED, WILL BE COMPLETE IN ITSELF.**

*Royal 8vo. size. All the volumes to be bound uniform in full cloth, Gilt.*  
The object of the work is to give, from the lips of the oldest inhabitants, or from other sources, a history of over 10,000 counties, districts, parishes, townships, cities, towns and villages, with descriptions of more than 3,000 islands, lakes and rivers, in the Dominion of Canada.

JOHN LOVELL, *Publisher.*

MONTREAL, Oct., 1889

# READY, RAPID & RELIABLE FIRE ESCAPE.

The Best, Safest and Quickest Means of Emptying School and other Dormitories in Case of Fire.

The accompanying cut exhibits the essential features of the contrivance, which may be adapted either to the interior or to the exterior of a building, but preferably to the latter, so as to create no draught for flame or smoke. *C c* represent the floor or, as in the present diagram, platforms which may assume the form of an ornamental balcony. These platforms are secured to the walls by suitable brackets *e e*. Two vertical shafts *f f* pass through the

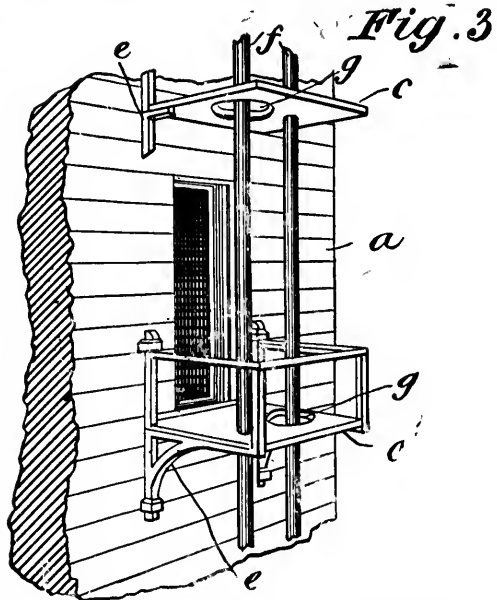

floors or staging from the roof to the ground; *g g* are circular openings which alternate from one side to the other at each succeeding landing. The landing to be placed before a window at every story.

The shaft to the left of *f*, and which is secured to the next platform above (not shown in the figure), is firmly clasped, not with the hands, but with the legs and arms, and the person slides down the shaft to the next landing below, regulating with ease, by the pressure of his limbs, the rapidity of the descent.

Inventor and Patentee,  
Rev. ARTHUR JONES,  
St. Mary's College, MONTREAL.

## TO ADVERTISERS.

### HOW TO GET THE MOST SERVICE FOR THE MONEY!

The Advertiser who would be willing to pay twenty-five cents for every family who could be "educated" up to the value of his goods would thus devote \$3,000,000 to educate the 12,000,000 families which make up the 60,000,000 people of the United States. This sum would do the business thoroughly in a year, for it is sufficient to pay for the insertion of a full column in every issue of every publication, and for resetting the matter, making it new in every issue of each separate publication. We will receive and execute the contract.

\$10.—We devote all necessary care to placing small orders for Advertising:—even the smallest! Time is saved by sending check with the order. Often the Advertiser is not possessed of sufficient information on the subject to enable him to judge of the merits of an estimate for advertising, and he decides by the footings of the figures whether he will or will not do the work. Yet the estimate binds the Agent, and makes it improper for him to make any variation in its specifications, however much his judgment may point to material changes which ought to be made. This is specially liable to be the case when the order comes a considerable time after the estimate was made.

\$50.—If you are in the habit of occasionally inserting a small advertisement in a few papers, investing a few dollars, and carefully noting the result, we desire you to make trial of our Advertising Bureau, sending us the advertisement and the money, leaving the selection of the papers to us, and judging of the service rendered by results rather than by names, circulation claims or prices. To make up careful estimates calls for much work. It does not pay to make them indiscriminately for every applicant. If such estimates as are asked for were always given, the Advertiser who wished to expend \$50 would frequently find himself in possession of the scheme which it would cost \$500 or possibly \$5,000 to carry out.

\$100.—The Advertiser who sends his advertisements, asking for the best service possible for one hundred dollars, will often get from five to fifty per cent. more service for his money than he would had he required us to tell him in advance exactly what service we would promise; for when an estimate has been given its plan and specifications must, in a general way at least, control the advertising to be done. It ties the Agent's hands, and prevents his giving his patrons *to-day* a better service than he could have promised yesterday, because yesterday the opportunity had not presented itself: *to-morrow it may have passed!* Some publications are used most economically on contracts for a single issue; in others, insertion for a month may be had as cheaply as for a single week; but in furnishing an estimate in advance, if the Agent attempts to go into details, his correspondence becomes voluminous and the advertiser confused.

\$250.—Prepare a small advertisement and send with check for \$250, or any other sum. The practice of asking the Agent to name his papers in advance compels him to name such as are well known, otherwise there is reason to suspect that his judgment is biased;—*and the best papers do not like to have their rates quoted below their schedule.*

\$500.—Leading newspapers, especially the leading Agricultural newspapers, frequently issue large special editions (of twenty, fifty, one hundred, or even five hundred thousand copies), and solicit advertisement orders from us, on terms which would often be accepted by our patrons. If there was time to invite attention to the matter; but the question must generally be decided before there would be time to write and receive a reply, and often the case cannot be fully stated within the limits of a letter.

\$1,000.—If we are given authority to insert advertisements to a limited amount, in such mediums as offer inducements which seem to us specially favorable, we shall not abuse the confidence reposed in us, and shall render statements of whatever is done (if anything) from day to day. When *trusted* with the placing of an advertisement, we are put upon honor, and are bound in honor to give the best service possible for the money to be used.

\$5,000.—One of the most successful Advertisers we ever had always ordered his advertisements in this way, "Get the best service you can for me for \$5,000," leaving every detail to us. We were thus enabled to say to a Publisher, if you put this in at a large reduction from your rate it will be no criterion for further transactions. It was a surprise to find ourselves so often able to contract for the insertion of that particular advertisement at half rates, in papers which would not permit us to offer their columns at a penny's deviation from their printed schedule. The advertising rate of one New York paper are double those of another which has twice the circulation of the first. Similar discrepancies are not uncommon. The advertisement entrusted to us to be placed in accordance with our judgment often does double service for half the money. A dollar for twenty-five cents.

The Oldest and Largest Roller Casting Establishment in New England.

ESTABLISHED 1859

## WILD & STEVENS,

MANUFACTURERS OF

Printers' Rollers and Roller Compositions,

No. 148 CONGRESS STREET, BOSTON.

# IT PAYS ADVERTISERS TO KEEP POSTED.



pays for a book of more than 200 pages devoted to Newspaper Advertising, and containing information valuable alike to experienced and intending advertisers.



pays for a year's subscription to PRINTERS' INK, a journal no advertiser alive to his own interests can afford to be without.

Issued twice a month and containing articles bearing on every branch in advertising; in fact the trade journal of American advertisers. A sample copy will be sent for Five Cents. Address

**GEO. P. ROWELL & CO'S**  
Newspaper Advertising Bureau,  
10 Spruce St., New York.

**ALBEMARLE HOTEL.**

EUROPEAN PLAN,  
Broadway, Fifth-ave. & 24th-st., New York.  
(MADISON SQUARE.)  
JANVRIN & WALTER, Proprietors.

**HOTEL KAATERSKILL,**

Catskill Mountains, New York,  
Largest and Finest Mountain Hotel in the world. Rates of board moderate.  
W. F. PAIGE, Manager.  
Kaaterskill P.O., Greene Co., New York

**WEST END HOTEL,**

LONG BRANCH,  
—SEASON OF 1889.—  
Cottages and Restaurant open Saturday, June 5th. Hotel opens June 22nd  
with improvements and additional attractions.  
D. M. & W. E. HILDKETH, Props

**ASTOR HOUSE,**

Broadway, New York.  
On the European Plan. | Rooms \$1.00 and Upwards.  
The accommodations of the Astor will be found first-class in every respect.  
Elevator running night and day.  
F. T. KEITH, Manager. | F. J. ALLEN, Proprietor.

**"THE BATES,"**

INDIANAPOLIS, IND.  
Rates, \$2.50 to \$5.00 per day.  
LOUIS REIBOLD, Proprietor.

**PARKER HOUSE,**  
BOSTON.

European Plan. 300 Rooms. \$1.00 and Upwards per day.  
Café of unsurpassed excellence. Private dining rooms for dinner parties.  
E. O. FENCHAUD & CO., Proprietors.

**TREMONT HOUSE,**  
BOSTON

THE "PALACE" HOTEL.  
JOHN A. RICE & CO.  
Prices, \$3.00 to \$5.00 per day. Special rates made by the week. Rooms  
single or en suite, with or without baths.  
MRS. JOHN A. RICE, Manager.

**ALBION HOTEL,**

MARKET SQUARE, - - - TORONTO.  
The best dollar a day house on the continent. Fine rooms; good service  
every convenience. Centrally located for railways, steamboats and street  
cars.  
JOHN HOLDERNESS, Proprietor.

**THE PALMER HOUSE,**  
TORONTO,

Corner King and York streets. Specially adapted for Commercial men.  
\$2.00 per day.  
J. C. PALMER, Proprietor.  
Also Kerby House, Brantford.

**ST. NICHOLAS HOTEL,**

EDWARD N. ROTH,  
CINCINNATI, OHIO.  
On the European plan. Location and service unsurpassed. Every modern  
improvement. Rooms, \$1.50 per day and upwards.

**GRAND UNION HOTEL.**

Opposite Grand Central Depot,  
NEW YORK.  
Six hundred rooms at \$1 a day and upwards. Restaurants at moderate prices.  
BAOAGAGE TO AND FROM GRAND CENTRAL DEPOT FREE.  
W. D. GARRISON, Manager.

**GRAND HOTEL,**

Broadway, cor. 31st-st., New York.  
ON THE EUROPEAN PLAN.  
HENRY MILFORD SMITH & SON, Props.

**THE GRISWOLD,**  
DETROIT, MICH.

Located corner Griswold and Congress-streets. Newly furnished and refitted  
throughout  
Rates, \$2 per Day.  
ALBERT MAXWELL, Proprietor. | E. T. OSBORN, Manager.

**FOREST CITY HOUSE,**  
CLEVELAND, OHIO.

Best location in the city, and the only hotel fronting on the park. Nearest  
to public buildings, opera house, churches, etc. Street cars pass the house to  
all parts of the city, suburbs and depots. Rates, \$2.50 and \$3 per day.  
TERRILL & INGERSOLL, Proprietors.

**FIFTH AVENUE HOTEL,**  
Madison Square, New York.

The largest, best appointed and most liberally managed hotel in the city,  
with the most delightful and central location. Conducted by HITCHCOCK,  
DARLING & CO., who first opened it to the public.

**THE WINDSOR HOTEL,**  
DENVER, COL.

Largest and most Elegant Hotel in the West.  
BUSH & MORSE, Proprietors.

**ADAMS HOUSE,**  
Washington-st., Boston.

ON THE EUROPEAN PLAN.  
Three hundred rooms. Private parlors, baths, etc. Best location in the  
city. A strictly first-class house.  
GEO. G. HALL, Proprietor.

**YOUNG'S HOTEL,**  
On the European Plan,

Head of State-st., Boston.  
Greatly enlarged and improved, and now offers superior accommodations for  
both ladies and gentlemen. Noted for the peculiar excellence of its cuisine.  
J. W. WHITTLE, Proprietor.

**TOWER HILL HOTEL**  
AND COTTAGES.

NARRAGANSETT PIER, R.I.  
Season 1889 opens June 25th.  
CHARLES A. OAKES, New York Office, 143 Broadway, Room 39.



WHO SUBSCRIBE TO THE

## "INDEX OF CURRENT EVENTS."

The "Index of Current Events" is much appreciated not only by the press of Canada and the United States, but also by the public men of both countries. Its list of subscribers includes such great newspapers as the Philadelphia *Ledger*, the Boston *Transcript*, the New York *World*, the Cincinnati *Enquirer*, the Brooklyn *Eagle*, the Toronto *Empire*, the Cleveland *Leader*, the Chicago *Herald*, the Cincinnati *Post*, the New York *Morning Journal*, the Chicago *Daily News*, the Indianapolis *Journal*, the New York *Star*, the Troy *Budget*, the Chicago *Staats Zeitung*, the New York *Nation*, the Troy *Press*, the Washington *Star*, the Chicago *Inter-Ocean*, and many less known but important newspapers. Some of these papers are well known to keep admirable indexes of their own, yet find it advantageous to subscribe to the INDEX OF CURRENT EVENTS. We have the honor to include among our subscribers, Her Majesty's Privy Council for Canada; also, Sir John Macdonald, G. C. B. Premier of the Dominion, Sir Hector Langevin, Minister of Public Works, Sir A. P. Caron, Minister of Militia, the Hon. G. E. Foster, Minister of Finance, the Hon. Mackenzie Bowell, Minister of Customs, the Hon. J. A. Chapleau, Secretary of State, the Hon. John Costigan, Minister of Inland Revenue, the Hon. John Haggart, Postmaster General, the Hon. John Carling, Minister of Agriculture, the Hon. C. H. Tupper, Minister of Marine and Fisheries, the Hon. Commissioner of Agriculture and Colonization Quebec, the Hon. Boucher de La Bruère, late speaker of the Legislative Council, Quebec, the Hon. Lieutenant Governor Royal, Mr. Erastus Wiman, the Hon. Minister of Public Works, Toronto. The Librarian of Parliament, the House of Commons Reading Room and the Librarians of many of the Provinces of the Dominion and States of the Union subscribe to the *Index*. Among the well known public librarians who subscribe are, Mr. J. C. Hurlbut, Librarian of the American Geographical Society, New-York, Mr. W. A. Bardwell, Librarian of the Brooklyn Library, Mr. W. H. Brett, librarian of the Cleveland Public Library, Mr. F. P. Jordan, Librarian of the Public School Library, Battle Creek, Michigan, Mr. W. T. Peoples, Librarian of the Mercantile Library, New-York, Mr. Robert E. Rich, Librarian of the Public Library, Portsmouth, N.

II., Mr. J. P. Dunn, Librarian of the Indiana State Library, Indianapolis, Mr. F. W. Vaughan, Librarian of the Social Law Library, Boston, Mr. James G. Barnwell, Librarian of the Philadelphia Library, the Librarian of the Providence Public Library, the Librarian of the Free Public Library, San Francisco, Mr. John M. Doane, State Librarian of Ohio, Mr. William H. Egle, State Librarian of Pennsylvania, Mr. M. Chamberlain, Librarian of the Boston Public Library, Mr. A. W. Whelpley, Librarian of the Cincinnati Public Library and Mr. C. B. Tillinghart, State Librarian of Massachusetts. The leading bankers (including the Bank of Montreal), brokers, lawyers and hotel keepers of Canada, and many clergymen also keep the *Index* on file.

What is thought of the *Index* may be gathered from the numerous entirely unsolicited expressions of approval sent in by well known public men, of which the following are specimens:

MR. MARTIN J. GRIFFIN, LIBRARIAN OF PARLIAMENT, Ottawa, writes and sending you a subscription for two copies of your "*Index*," which will be most useful and which deserves encouragement. If you will take particular pains to give the dates and figures of elections and the dates of speeches of public men, with reference also to the place at which the speech was delivered, you will do a very grateful thing for public people and editors, and I may add librarians.

MR. JOHN M. DOANE, STATE LIBRARIAN OF OHIO, writes:—Enclosed please find six dollars, in payment for State Library subscription to the "*Index of Current Events*" for 1888.

I regard it as a very valuable publication, and hope that you may meet with such success as to warrant its continuance, for it will grow more valuable every year.

MR. HERBES, OF THE BROOKLYN *Eagle*, writes:—"I congratulate you most heartily upon having done a good thing, a very good thing, in starting the "*Index*." enterprise. I hope I may have the joy of congratulating you upon your success a year hence. A man with *Index* on the brain is one after my own heart. My judgment was formed upon Number 1; if the indexing is kept up as thoroughly in all subsequent numbers it will be a great help to us."

SIR CHARLES TUPPER, BART., HIGH COMMISSIONER FOR CANADA, writes:—"It seems to me to be a very useful publication, and one that will be valuable for reference purposes."

MR. BURK, ASSOCIATE EDITOR OF THE PHILADELPHIA *Public Ledger*, writes:—"Your *Index* is highly appreciated at this office, where it has long been a desideratum."

MR. COLQUHOUN OF THE "TORONTO *EMPIRE*," writes:—"Allow me to congratulate you most cordially upon your admirable *Index*. The idea and its execution are alike worthy of all praise."

MR. VALEN, OF THE "NEW-YORK *MORNING JOURNAL*," writes:—"I find the *Indices* of great value, saving, as they do, much valuable time in looking up important events."

MR. WILL A. WOODWARD, REC. SEC. MASS. PRESS ASSOCIATION, writes: Enclosed please find subscription for one year for "*Index of Current Events*." I have examined the specimen sent me with much interest and do not hesitate to commend it as an invaluable assistant in the newspaper office. The amount of time and labor it is calculated to save, cannot be compensated by one hundred times its subscription rate.

Commencing with Vol. II No. 1 the dates given in the *Index* are the actual dates of the occurrences; not as formerly the dates of publication.

The *Index* is published four times a month; but to form a complete file for the year it is necessary to preserve only the first issue in each month.

The intermediate issues contain the news of the current month to date.

The subscription is \$6 per annum, payable yearly or half yearly in advance. Remittances should be made to

HENRY DALBY,

P. O. Box 864,

MONTREAL, Que.

THE  
**INDEX OF CURRENT EVENTS.**

Vol. 11, No. 40.

MONTREAL, NOVEMBER 7, 1899.

\$5.00 PER ANNUM.  
PUBLISHED WEEKLY.

OCTOBER.

Abyssinia, Italian Government declare protectorate over.—Oct. 14.

ACCIDENTS.—Cliff Slide, Quebec, *Electeur* condemns jury's verdict on accident in condemning corporation of.—Oct. 2.

Cliff slide, Quebec, city attorney Hon. Mr. Pelletier makes motion to annul jury's verdict on late accident.—Oct. 10.

Earthquake, Central, Haits, N. S., severe shock of, felt at.—Oct. 23.

Electricity, New York, line man killed.—Oct. 8.

Electricity, New York, line man J. Feeks falls into network of live wires and is roasted to death.—Oct. 14.

Electricity, New York, coroner's jury in case of lineman Feek's death by, condemn present system of conducting electricity.—Oct. 29.

Explosion, Colliery, Langdon, Eng., seventy miners entombed at.—Oct. 16.

Explosions, London, Ont., boiler in Dorey's mill explodes, J. Ross killed, great damage.—Oct. 10.

Explosions, Montreal, dynamite explosion in city kills one man, injures many, and causes great destruction to property.—Oct. 24.

Explosions, New Orleans, S.S. "Corono" bursts her boiler, killing 18 persons, near.—Oct. 3.

Explosions, Tunis Bay, S.S. "Ville de Brest" bursts her boiler, 5 persons killed.—Oct. 28.

Fires, Cleveland, Ohio, grocery house of W. Edward & Co., loss \$125,000.—Oct. 9.

Fires, Forest, Mission Creek county, Minn., reported a blaze.—Oct. 16.

Fire, Koenigsberg, Docks at, destroyed, enormous damage.—Oct. 28.

Fires, New York, Brooklyn Tabernacle at.—Oct. 13.

Fires, St. Sauveur, Quebec, money for sufferers by late fire distributed.—Oct. 12.

Floods, Japan, great floods in, cause immense loss of life and property.—Oct. 4.

Flood, Johnstown, Pa., organization for searching for victims of late flood formed at.—Oct. 23.

Floods, Jura and France, severe floods, great damage in.—Oct. 11.

Floods, St. Petersburg, Ft. Neva raics, swamping lowest part of city.—Oct. 23.

Floods, Tyrol, much damage caused by, in.—Oct. 13.

Jumping, Trenton, N. J., Peynaud leaps from tower 150 ft. high, and is killed.—Oct. 1.

Natural Gas, Bradford, four persons roasted by natural gas.—Oct. 11.

Railroad, Gibson, Neb., collision of Burlington R.R. injures 50 passengers severely.—Oct. 16.

Railway, Incline R.R., Cincinnati, Ohio, many passengers killed and wounded at, by fall of cars 300 ft.—Oct. 15.

Railroads, Post Quasurtz Posen, passenger and freight collide, killing 5 persons.—Oct. 4.

Railway, Patras, Greece, fifteen persons killed by collision of trains at.—Oct. 28.

Railway, Savon, France, pilgrim train, with 500 passengers, collides with another train, several killed, many injured.—Oct. 25.

Shipping, Fredericksburg, SS. "Quinte," of Deseronto Navigation Co., burned, many passengers injured.—Oct. 23.

AFRICA, German E. A. Co. reports loss up to Jan. 1, 1899, of 2,034,549 marks.—Oct. 7.

Brussels, Royal decree issued in, in favor of American mission in Congo to evangelize the natives of.—Oct. 10.

Africa, Solar expedition leave, per SS. "Pensacola."—Oct. 16.

French Gov. impose prohibitory duties up to 100 per cent. on imports to their possessions on Gold Coast.—Oct. 17.

Zanzibar, Sultan, of, gives written promise to British Consul that all children born in his domains after Jan. 1st, 1899, shall be free.—Oct. 19.

Congo State, governor of, reports that 80 chiefs have recognized his authority.—Oct. 19.

Ungavolo, Ecclesiastical Jesuit missionaries expelled from.—Oct. 21.

AFRICA.—Continued.

Zanzibar, Capt. Wissman defeats chief Bushire with heavy loss in.—Oct. 26.

AMERICAN NATIONAL CONVENTION.—Chilean and Argentine Republic delegates express dissatisfaction at election of Mr. Blaine as President of International Congress.—Oct. 3.

Approves of union of Central States.—Oct. 22.

American, Report, New York, *Herald* of, states Blaine will ask Hayti, San Domingo and Cuba to enter U. States.—Oct. 16.

Arctic exploration, party of Arctic Circle explorers heard from at Winnipeg.—Oct. 27.

Art, New York, Milau's picture the "Angelus" purchased for \$100,000 by American Art Association arrives at.—Oct. 13.

Athens, Princess Arphie arrives at.—Oct. 25.

Austria, decree issued that state officials, shall continually wear uniform on and off duty.—Oct. 21.

Behring Sea, Commander of "Itash" makes report on seizures in.—Oct. 14.

Birthis, Bendersville, Pa., Mrs. Bender, of four children at.—Oct. 25.

Brazil, Yellow fever reported to be raging in.—Oct. 28.

Brussels, board of trade resolves to hold a Belgian exhibition in London.—Oct. 23.

Bulgarian Government of, arrange for loan of £1,000,000.—Oct. 7.

Canada, Deputation of Americans reach.—Oct. 13.

Chamberlain in speech at Newcastle, Eng., taunts Home Rulers with making no effort to meet dissenters in argument.—Oct. 2.

Chicago, Clan-na-Gael conspirators hold session in.—Oct. 4.

Chicago, Statue of La Salle (French explorer) unveiled at.—Oct. 12.

Chili, law enacted abolishing import duty on tools, etc.—Oct. 18.

China, Red River declared open for trade.—Oct. 19.

China, arrangements for establishment of new medical service for army and navy made.—Oct. 24.

China, Yang-Tse-Kiang Valley, China Rain destroys rich cotton crop of.—Oct. 27.

Chinese, Victoria, B. C., Minister of Interior in speech at, favors Chinese immigration.—Oct. 26.

Cholera, reported that Asiatic cholera has come in S. E. Europe.—Oct. 2.

Confederate Bonds, English holders of Confederate bonds endeavor to obtain some return for them.—Oct. 4.

CRETE, Insurgents attack Turkish troops.—Oct. 4.

Reported that Sultan will grant amnesties to insurgents.—Oct. 6.

Report that Turkish Government of, allowed troops to pillage, etc. confirmed by *London Times*.—Oct. 7.

Natives of, repulse Turkish troops, killing officer.—Oct. 12.

Conflicts between Turks and natives of, continue.—Oct. 14.

Four Turkish battalions of Infantry revolt in.—Oct. 17.

Five hundred fugitives take refuge in Syria from.—Oct. 22.

Porte forbids dispatch of Cipher telegrams from.—Oct. 24.

CRIME, adultery, Chicago, rev. J. McLeod arrested at, on charge of adultery and bigamy.—Oct. 1.

Assault, Earl of Galloway charged with assaulting a little girl.—Oct. 4.

Assault, London, Earl of Galloway acquitted.—Oct. 11.

Faction Fight, Pineville Ry., Turner and Howard factions have a severe fight at, one man killed, many injured.—Oct. 23.

Fraud, New York, Count de Vermont, a noted swindler, arrested on charge of forgery.—Oct. 3.

Gambling, London, principal members of Cranbourne Club, found guilty of gambling, and fined.—Oct. 3.

Kidnapping, New York, J. Fitzpatrick arrested for sending men to Isthmus of Panama.—Oct. 1.

Poisoning, St. John, N.B., Mrs. MacRae poisoned with candy, also attempt on lives of two clergymen.—Oct. 3.

Poisoning, St. John, N.B., Wm. McDonald arrested on charge of being perpetrator of late deaths by poisoned candy.—Oct. 6.

Poisoning, St. John, inquest continued in poisoned candy case, strong evidence against McDonald elicited.—Oct. 19.

CRIME.—Continued.

Rape, Wake, N. C., R. C. Priest, Father Boyle, sentenced for assault on Miss Whittaker.—Oct. 6.  
 Shooting, Sherbrooke, trial of D. McLean, for shooting to kill, opened at.—Oct. 9.  
 Dakota, S. Legislature of, vote for U.S. senators.—Oct. 16.  
 Dakota, N., 20,000 people reported destitute in.—Oct. 29.  
 DEATHS, Dupré J., an eminent French artist, at Paris.—Oct. 7.  
 Doidesdorf Professor, the celebrated lunacy specialist.—Oct. 9.  
 Fitzgerald Baron, Dublin.—Oct. 16.  
 Gaston Melingue, French painter.—Oct. 6.  
 Gooch Sir D., famous engineer, at London, England.—Oct. 15.  
 Hardisty Senator, Winnipeg, Man., nt.—Oct. 15.  
 Levin and Melville, Earl of, at London.—Oct. 22.  
 McNair W. W., famous explorer, at London, England.—Oct. 15.  
 Morris Hon. A., at Toronto.—Oct. 28.  
 Munich, Dr. Von Steitchel, Catholic Archbishop of.—Oct. 10.  
 Oakes Hon. E. R., M.P. for Digby.—Oct. 16.  
 Orkney Earl of.—Oct. 23.  
 Portugal, King of, at Lisbon.—Oct. 19.  
 Ramsay Alex., manager of Standard Life Ins. Co., of Canada.—Oct. 7.  
 Tandy T., Gen. Freight Agent of G.T.R., at Montreal.—Oct. 4.  
 Turner Hon. Senator, at Hamilton.—Oct. 19.  
 Vail J. A., D.D., Bishop of Kansas, dies.—Oct. 6.  
 Workman Thos., prominent citizen of Montreal.—Oct. 9.  
 Derby, Eng., Lord Derby in speech at, endorses Mr. Gladstone.—Oct. 24  
 Diphtheria, Carbondale, Pa., epidemic of malignant diphtheria breaks out in.—Oct. 5.  
 Diplomatic, Paunceforte Sir Julian, British Minister to U.S., arrives at New York.—Oct. 15.  
 Divorce, New York, R. R. Hamilton takes action to obtain divorce from his wife who figured in recent assault scandal.—Oct. 3.  
 Earthquake, Mitylene, Turkey, lighthouse wrecked, with loss of life at.—Oct. 27.

ECCLESIASTICAL.—Continued.

Cleveland, O., Pope appoints Archbishop Riordan and Cardinal Gibbon to investigate affairs under Bishop Gilmore in diocese of.—Oct. 1.  
 Abbe Nordius newly arranges ancient chants of the R.C. Church.—Oct. 28.  
 Baltimore, second biennial conference of young women C.A. held at.—Oct. 22.  
 Brooklyn, N. Y., Dr. Talmage's new tabernacle commenced at.—Oct. 28.  
 France, Zadok Khan, elected Grand Rabbi of.—Oct. 24.  
 London, Bishop of, presides at meeting, object to purify the music halls.—Oct. 11.  
 London, Ont., Dr. Walsh, R. C. Archbishop of, resigns his See.—Oct. 19.  
 Lon, Eng., Rev. P. J. Benson suspended for year for not administering sacrament to Mrs. Swayne at.—Oct. 26.  
 Montreal, ceremony of blessing unadornment of Laval and Victoria Universities celebrated in Notre Dame Cathedral.—Oct. 13.  
 New York, Cardinal Lavigerie says a Frenchman will not succeed Leo XIII.—Oct. 16.  
 New York, eightieth anniversary of American Board of Foreign Missions celebrated at.—Oct. 15.  
 New York, Presbytery of, forward a proposed revision of the Westminster confession of faith to be debated on by General Assembly.—Oct. 15.  
 New York, Episcopal Convention at, agree to appoint committee to prepare a standard prayer book to be submitted in 1892.—Oct. 16.  
 New York, Episcopal Convention at, decide against establishment of a missionary episcopate for negroes.—Oct. 18.  
 New York, Episcopal Convention discuss ritual reform.—Oct. 20.  
 New York, Episcopal, Centennial, General Convention discuss Nicene creed.—Oct. 3.  
 New York, Episcopal Convention, Rev. Dr. Gibson offers resolution providing for insertion of Athanasian Creed in book of Common Prayer.—Oct. 8.  
 New York, Episcopal Convention at, appropriate \$40,000 for colored people in South.—Oct. 14.  
 New York, Episcopal Convention discuss revised hymnal.—Oct. 14.  
 New York, Protestant Episcopal Convention refuse to accept report of conference committee, recommending changes in book of short offices.—Oct. 23.  
 New York, Episcopal Convention adopts canon on deaconesses.—Oct. 24.

ECCLESIASTICAL.—Continued.

New York, high and low church factions of Protestant Episcopal Convention at, disagree over proposed revision of Book of Common Prayer.—Oct. 25.  
 New York, Protestant Episcopal Convention closes at.—Oct. 29.  
 Ohio, Rev. W. A. Leonard, D.D., consecrated as Bishop of, at New York.—Oct. 11.  
 Ottawa, census of attendance at Protestant churches taken, number 7,328.—Oct. 14.  
 Ottawa, Baptist Convention held at.—Oct. 16.  
 Ottawa, Baptist Convention discuss Church and State.—Oct. 18.  
 Ottawa, Baptist Convention closes.—Oct. 22.  
 Palermo, Italy, Prime Minister Crispi states in speech at, that Government must not be dictated to in any way by the Pope.—Oct. 15.  
 Pope sends congratulatory letter to R. C.'s of America, on centennial of establishment of first See in country.—Oct. 16.  
 Quebec, Cardinal Taschereau confirms 300 children.—Oct. 3.  
 Rome, Convention between Vatican and Russia signed at.—Oct. 10.  
 Rome, Pope receives letters from Pres. Carnot, thanking him for his neutrality in French elections.—Oct. 10.  
 Rome, Prussian Envoy to Vatican discusses Pope's departure from Rome with him.—Oct. 10.  
 Rome, Riforma of, declares pilgrimages to Vatican are becoming political demonstrations, therefore illegal.—Oct. 28.  
 Russia, Governor of, concedes Vatican's demands, 7 Russian bishops to be appointed.—Oct. 27.  
 St. Paul, Minn., Synod of Presbyterian Church of, opens at.—Oct. 20.  
 Toronto, Methodist Church, scale of appropriation discussed, committee appointed for various works of body, financial standing announced.—Oct. 8.  
 West Port, Ont., Archbishop Cleary excommunicates woman at.—Oct. 29.  
 Winnipeg, Anglican Synod closes at.—Oct. 30.  
 Educational, Springfield, Mass., French Protestant College dedicated in.—Oct. 21.  
 Educational, Wycliffe College, Toronto, announced that Divinity degrees will in future be given from.—Oct. 11.  
 Educational, Montreal Annual Convention of Protestant teachers of Province of Quebec held at.—Oct. 24.  
 Educational, Montreal, Dominion Conference proposed at session of school teachers, drawing in schools discussed. Conference closed.—Oct. 25.  
 Educational, Montreal, Protestant Teachers Convention discuss Canadian History, sensational literature denounced.—Oct. 25.  
 Egypt, Cairo, report of Dervish advance from Omdurman received at.—Oct. 28.  
 ELECTIONS, Paris, Chamber of Deputies officially announced that, will be composed of 262 Republicans, and 205 members of opposition.—Oct. 6.  
 Brighton, England, Mr. Lodor (Unionist) elected for.—Oct. 25.  
 Buckinghamshire, N. Eng., Capt. E. H. Verney, Gladstonian, returned for.—Oct. 12.  
 Helena, Montana, returns from every county but one show Republicans to have 38 members of Legislature, Democrats 32.—Oct. 16.  
 Joliette, Q., Bazinet, Liberal, and Perrault, Conservative, nominated for Legislature.—Oct. 16.  
 Joliette Co., P.Q., Mr. Bazinet, Liberal, elected for Legislature.—Oct. 23.  
 Montana, new State of Montana goes Democrat.—Oct. 9.  
 Nairn, Scotland, Reay liberal returned for 2,571 votes.—Oct. 7.  
 Peterborough, Eng., Mr. Morton, Gladstonian, returned for.—Oct. 7.  
 Quebec, writs for Joliette election issued.—Oct. 6.  
 Richelieu, political campaign in county of, opens, speeches by Hon. J. A. Chapleau and others.—Oct. 3.  
 Richelieu P.Q., J. A. Massie returned for.—Oct. 18.  
 Richelieu, P.Q., Liberals select Mr. H. Beauchemin as candidate for county.—Oct. 6.  
 Victoria, B.C., Thos. Earle to House of Commons for.—Oct. 29.  
 Electricity, extension by, Mr. Edison addresses letter to Paris Academy of Science, recommending alternative currents far.—Oct. 13.  
 Electricity, Auburn, N.Y., Penmler sentenced to execution by electricity.—Oct. 14.  
 Electricity, London, Eng., experiments to light city of, to be tried on a gigantic scale.—Oct. 22.  
 Electricity, Nashville, Tenn., order that all street railroads be run by electricity.—Oct. 29.  
 Electricity, New York, Board of electrical control announce that in examination of wires 400 cases of dangerous defects in insulation discovered.—Oct. 12.

El  
En  
Ep  
En  
Ep  
Eq  
Ekb  
FAI  
Fam  
Fish  
Flood  
Fore  
FRA  
E  
E  
G  
D  
Pa  
Bo  
Ca  
Co  
Co  
Ele  
Ele  
Fl  
E  
Epl  
Gen  
10  
Pari  
Pari  
Re  
Pres  
res  
GERMA  
Berli  
Berli  
Berli  
Berli  
no  
Dent  
Diap  
G  
A  
Gran  
cor  
Kiel  
for  
Reich  
Reich  
Prussi  
Prussi  
on t  
Gladstone  
elect  
Gladstone  
of te  
Glasgow,  
borou  
Hamilton f

Electricity, Pekin, China, to be lighted by.—Oct. 30.  
 End of world prophesied by second adventists, for Oct. 25.—Oct. 23.  
 Epidemics, Dover, N.H., all schools of, closed, owing to spread of diphtheria.—Oct. 12.  
 Engineers, Denver, Col., Brotherhood of Locomotive Engineers of U.S. convened at, Chief Arthur addresses meeting.—Oct. 16.  
 Epidemics, cholera appears in Mesopotamia and Persia.—Oct. 19.  
 Epidemic, Pelee Island, Lake Erie, smallpox appears in.—Oct. 16.  
 Equal Rights, Ottawa, Association of, protect against appropriation of public money for support of sectarian schools.—Oct. 16.  
 Exhibitions, Sherbrooke, Minister of Agriculture cancels \$2 000 grants for.—Oct. 4.  
 FAILURES, Hamilton, Ont., T. Boggess, manufacturer, signs, liabilities \$130,000.—Oct. 4.  
 Philadelphia, Heston & Erben, wood dealers, liabilities \$400,000.—Oct. 29.  
 Famine, Current Island, Belle Isle Straits, people of, reported starving owing to fishing failure.—Oct. 26.  
 Fisheries, Halifax, American fishing schooner "D. Adams" confiscated at, for violating treaty of 1818.—Oct. 28.  
 Floods, Austria Tyrol, cause great damage.—Oct. 15.  
 Forestry, Philadelphia, American Forestry Congress hold annual meeting at.—Oct. 15.  
 FRANCE, Boulanger leaves England for Isle of Jersey.—Oct. 7.  
 Election, Belleville, M. Rochford asks electors of, to plump him against the dictatorial behaviour of the Government.—Oct. 3.  
 Elections, Paris, Boulangerists, M. Deroulé and Costellin attacked and beaten in.—Oct. 3.  
 Government of, decide to prosecute *Intransigeant* for stating that war office funds were used in elections.—Oct. 1.  
 Paris, *Times* says for time Boulangerism is vanquished, but may appear again.—Oct. 6.  
 Paris, new statue of Republic placed on Place de Nation.—Oct. 16.  
 Boulanger requests M.M. Drouvel and Naquet not to visit him at Jersey.—Oct. 12.  
 Cabinet expel M. Laisant (Boulangist) from army.—Oct. 19.  
 Conservative leaders in, decide not to recognize Republic.—Oct. 12.  
 Council of war decide to increase strength of sixth army corps.—Oct. 11.  
 Election, in compliance with Pres. Carnot's request ministry refuse to resign.—Oct. 9.  
 Election, aggregate vote cast in, announced to be, Republicans 4,012,353, Conservatives 2,340,681, Boulangist 1,037,696.—Oct. 11.  
 Epinouse, monument commemorating Gambetta's escape from Paris in balloon during siege, unveiled at.—Oct. 12.  
 Gen. Ferrer appointed Grand Chancellor of Legion of Honor.—Oct. 10.  
 Paris, Ex-King Milan visits.—Oct. 11.  
 Paris, *Times* correspondent at, announces the abolition of the Republican groups in New Chamber.—Oct. 29.  
 President Carnot tells Cabinet he will decline to accept any Minister's resignation.—Oct. 27.  
 GERMANY, estimated loan to Reichstag to be 250,000,000 marks.—Oct. 4.  
 Berlin, Banquet given in honor of Princess Sophie.—Oct. 14.  
 Berlin, Czar visits.—Oct. 11.  
 Berlin, Czar leaves city suddenly.—Oct. 12.  
 Berlin, Count Von Walderfel, chief of army staff, says Germany is not anxious for war, but can meet should it come.—Oct. 31.  
 Dentz, police notify Count Dillon to leave.—Oct. 24.  
 Disputes English right to isles of Manda and Patta.—Oct. 11.  
 Government of, decide to make Oct. 18th, Emperor William's birthday, a German national holiday.—Oct. 14.  
 Grant of 120,000,000 marks asked for establishment of ten new army corps for.—Oct. 9.  
 Kiel, Shipbuilding yards obtain contract for building four ironclads for Government of.—Oct. 16.  
 Reichstag of, opened.—Oct. 22.  
 Reichstag of, re-elect Herr Von Kervetow president.—Oct. 24.  
 Prussia Bundesrath of, adopts the permanent Socialist bill.—Oct. 24.  
 Prussia Bundesrath of, creates Court of Appeal with eleven judges on bench.—Oct. 25.  
 Gladstone Mr. W. E., delivers great speech at Southport on Irish election question.—Oct. 23.  
 Gladstone Mr. W. E., speaks on favorable condition of working classes of to-day at Chester.—Oct. 26.  
 Glasgow, Scotland, advices from, announce advance of 2s. in Middlesborough and Scotch pig iron.—Oct. 24.  
 Hamilton foundation stone of new public library laid at.—Oct.

Hawaii, American Government intriguing to obtain possession of.—Oct. 8.  
 Hayti, Genl. Hippolyte elected president of.—Oct. 17.  
 Health Congress, Brooklyn, N.Y., Convention of Health Congress closes.—Oct. 23.  
 Indianapolis, Ind., agent of English Syndicate completes purchase of Man's Schmidt's and Lieber's breweries.—Oct. 15.  
 Indians, massacre, Sonora, Tex., two companies of Mexican soldiers slaughtered by Yuki Indians.—Oct. 19.  
 Indians, Minnesota, Chippewa Indians sell their preserves to United States.—Oct. 9.  
 Indians, Ottawa, two chiefs of six nation Indians arrive at, and request abolition of council system.—Oct. 23.  
 IRELAND, Co. Clare, laborers of, form Laborers League.—Oct. 1.  
 Cork, Canon Griffin of, condemns statements made by T. Healy, M.P., that renunciation by Balfour of Irish Catholic University scheme was a blow to consolidation of British power at Vatican.—Oct. 1.  
 Costs on Irish side of Parnell *Times* case published.—Oct. 5.  
 Dublin, New Viceroy, Earl of Zeeland, sworn in, at.—Oct. 6.  
 Dublin, Nation dists meet in Dublin and establish Tenants Defence League.—Oct. 24.  
 Perth, Sir R. Churchill in speech at, admits obligation of Government to pursue a generous policy towards.—Oct. 7.  
 Iron, Glasgow, Scotland, big advance in pig iron reported from.—Oct. 10.  
 Italy Government refuse to receive W. Effendi as Turkish ambassador.—Oct. 18.  
 Italy, Palermo, Premier Crispi in speech at, declares European peace assured.—Oct. 16.  
 JESUITS ESTATES.—Text of resolutions passed by Protestant Council of Education published.—Oct. 1.  
 Division of the \$400,000 made known.—Oct. 24.  
 Montreal, Dalton McCarthy, M.P., arrives in, at.—Oct. 7.  
 Halifax, N.S., Presbyterian Synod of amend Dr. Burn's motion on.—Oct. 8.  
 Montreal, Daniel McCarthy, M.P., speaks at, appeals for one nationality, treats on French language in Manitoba and revision of constitution.—Oct. 9.  
 Quebec, Premier Mercier speaks on constitutionality of Act, Rights of Province of Quebec, etc.—Oct. 9.  
 Quebec, Premier Mercier replies to Bishop of Quebec concerning resolutions of P. C. of P. 1. on, and the \$10,000.—Oct. 10.  
 Sorel, P.Q., great meeting held at Puce, Riel rebellion and Jesuitism discussed.—Oct. 11.  
 Toronto, equal rights meeting held at.—Oct. 10.  
 Jews, several thousand expelled from Russia, leave England for Argentine Republic.—Oct. 4.  
 Journalistic, Berlin, editor of *Hamburgerische Zeitung*, sentenced to month imprisonment for reprinting insulting article on Empress Frederick.—Oct. 4.  
 Journalistic, London, Eng., proprietors of *Mining Record and Financial Times* of, arrested on charge of extortion.—Oct. 16.  
 Journalistic, Montreal, *La Bibliothèque* sues *La Justice* for \$25,000 damages for libel.—Oct. 14.  
 Judicial, Nova Scotia, Judge Smith, of Supreme Court of N.S., resigns.—Oct. 15.  
 Kingston, People's Political Party organized at.—Oct. 23.  
 LABOR, Hanover, proprietors of great works at Lengen concede advance of 10 per cent. to employees.—Oct. 11.  
 London, two thousand women workers hold meeting with object of improving their condition.—Oct. 7.  
 Rome, Pope requests Cardinal Manning to supply him with information regarding existing religions between workmen and employers in England.—Oct. 10.  
 Labrador, report that people of, are starving, confirmed.—Oct. 17.  
 LEGAL.—Jesuit *Mail* case, Montreal, supplementary factum filed by Mr. J. J. Curran in.—Oct. 8.  
 Montreal, Judge Delcorimer in Aggie Ashton case decides that the mother has right of custody of her own child.—Oct. 9.  
 Montreal, cloistered nuns exempted from appearing in Court by Justice Maitten, in "La Banque Ville Marie vs. Hotel Dieu" case at.—Oct. 24.  
 Montreal, judgment of \$500 damages given against *Le Monde* at, for styling Mr. Noyes an orangeman.—Oct. 30.  
 Montreal, \$900 damages awarded to Morse vs. Allan S.S. Co. for detention of cattle in 1889 by latter.—Oct. 29.  
 Montreal, Hon. J. A. Chapleau sues Hon. F. X. A. Trudel for \$50,000 damages for libel.—Oct. 25.

## LEGAL.—Continued.

New York, application of Western Union Tel. Co., to have injunctions restraining board of electrical control for interference with wires, refused by Judge Ingraham.—Oct. 15.

Quebec, Judge Bosse refuses to grant motion setting aside part of verdict on late cliff catastrophe.—Oct. 21.

Windsor, Dr. Aikman commences suit against Judge Horn for false imprisonment, claiming \$50,000.—Oct. 1.

London, company formed in, to erect tower of Eiffel plan.—Oct. 21.

Manitoba, Winnipeg *Sun* of, states reason of Mr. Prendergast's resignation as Provincial Secretary of Manitoba, due to failure to get appropriation for French clerk appointed by him.—Oct. 25.

Maritime Conference, Washington, D.C., British delegates object to comprehensiveness of programme of.—Oct. 17.

MARRIAGES.—Paris, Prince of Monaco to Duchess de Richelieu at.—Oct. 30.

Vienna, Archduke Leopold to Princess Blanche of Castile.—Oct. 24.

Athens, Crown Prince of Greece to Princess Sophie of Prussia at.—Oct. 27.

Paris, the marriage between Prince Murat and Miss Caldwell to be abandoned.—Oct. 31.

MEDICAL.—Boston *Herald* exposes more bogus diploma doctors.—Oct. 3.

Montreal, Governors of the General Hospital oppose amalgamation with Royal Victoria Hospital.—Oct. 3.

Montreal, Laval and Victoria faculties amalgamated.—Oct. 9.

Montreal McGill College, Faculty of Veterinary Science established in.—Oct. 23.

North American Review for October publishes article on facility with which medical degrees are obtained in United States.—Oct. 1.

Mexico, \$2,500,000 worth of debt bonds stolen from Treasury of.—Oct. 19.

Mexico, lost Government bonds found.—Oct. 22.

MILITARY.—Montreal, Connecticut National Guard visit city.—Oct. 3.

Bavaria, cavalry of, armed with lances.—Oct. 12.

General Brialmont, the eminent Belgian engineer, denounces new U.S. Zuluski dynamite gun.—Oct. 27.

Germany Budget presented to Reichstag increases army vote 140,000,000 marks.—Oct. 22.

Italian Government order 50,000,000 smokeless powder cartridges.—Oct. 16.

Kingston, Rifle Association of, hold annual meeting at Barriehfield ranges.—Oct. 17.

Ottawa, Sir A. P. Caron states that Gaidet Corps if unconnected with schools will not be recognized by Government.—Oct. 30.

Quebec, B. Battery defeat A. Battery, manual shifting competition, time 48 seconds.—Oct. 4.

Richmond, Va., Lord Wolsey notifies Gov. Lee that he will attend unveiling of Lee statue at.—Oct. 12.

Swansen, Eng., Gen. Grenfell gives reception at.—Oct. 12.

Switzerland, Budget of, appropriates 9,000,000 marks for renewing army rifles.—Oct. 29.

Mining, American Mining Engineers visit Montreal.—Oct. 5.

Minnesota, starvation amongst settlers of, reported.—Oct. 22.

Mississippi Valley, wheat growers of, organize company with \$20,000,000 capital.—Oct. 23.

Montana, State of, white population of, reported to be 170,000, Indians 15,000.—Oct. 26.

Montreal, annual meeting of Dominion Flour and Meal examiners, officers appointed.—Oct. 25.

Montreal, by-law authorizing million dollar loan passed by city council of.—Oct. 24.

Montreal, McGill University, late Mr. Workman bequeaths \$120,000 to.—Oct. 14.

MURDER.—Chicago, Cronin, 627 jurors excused.—Oct. 1.

Chicago, Cronin, fixing of jury ordered, new developments in case, additional arrests made.—Oct. 12.

Chicago, Cronin, three new suspects arrested at.—Oct. 12.

Chicago, Cronin, many true bills found against jury bribers.—Oct. 14.

Chicago, Cronin trial, jury bribery brought to light.—Oct. 16.

Chicago, Cronin, M. Slottenberg arrested as one of jury bribers.—Oct. 16.

Chicago, Cronin trial, break in Grand Jury reported, Bailiff Hanks makes remarkable confession.—Oct. 17.

Chicago, Cronin trial, eleven jurors secured.—Oct. 10.

Chicago, Cronin trial, alleged plot to rescue Burke and Coughlin.—Oct. 19.

Chicago, Cronin trial, Beggs tells story of murder.—Oct. 21.

## MURDER.—Continued.

Chicago, Cronin, jury impanelled, trial begins.—Oct. 23.

Chicago, Cronin, opening speech by Mr. Longenecker, State attorney details motive of crime.—Oct. 24.

Chicago, Cronin, hold move on part of State authorities, testimony given.—Oct. 25.

Chicago, Cronin, Winnipeg *Free Press* publishes account of murder given by Heffer, fellow-prisoner with Burke.—Oct. 25.

Chicago, Cronin, strong evidence brought against prisoner.—Oct. 26.

Chicago, Cronin, Mr. Conklin tells how Cronin was lured to his death. Evidence corroborated by a reporter.—Oct. 28.

Chicago, Cronin, Clan-na-Gael methods detailed by members of camp No. 26.—Oct. 29.

Chicago, Cronin, members of camp No. 20 detail how secret committee was appointed.—Oct. 30.

Dubuque, Ia., W. Elkins confesses to have killed his father and mother.—Oct. 21.

Flournoy, Ariz., five Apache Indians sentenced to death.—Oct. 18.

Hamburg, Germany, woman killed, Jack the Ripper style.—Oct. 17.

Hamburg, Germany, mutilated body of girl found.—Oct. 23.

Morrison trial, Sherbrooke, opening day of prisoner pleads not guilty to all charges, difficulty in finding a jury.—Oct. 1.

Megantic, Morrison trial, Sherbrooke, P.Q., bitter feeling manifest at counsel for prosecution tries to break down defence.—Oct. 3.

Megantic, Morrison trial, Sherbrooke, case for Crown closes, Crown adjourns at request of prisoner's counsel.—Oct. 4.

Megantic, Morrison trial, Lake Megantic, P.Q., defence commenced.—Oct. 5.

Megantic, Morrison trial, prisoner's counsel pleads his case.—Oct. 7.

Megantic, Morrison trial, Sherbrooke, P.Q., verdict of manslaughter with recommendation to mercy returned against prisoner.—Oct. 9.

Megantic, Morrison trial at Sherbrooke, prisoner sentenced to 18 years penitentiary by Judge Brooks.—Oct. 11.

St. John, N.B., MacIver candy poisoning case, coroner's jury return verdict of wilful murder.—Oct. 19.

Whitechapel, Jack the Ripper sends letter to Whitechapel vigilance committee, announcing another murder for 19th inst.—Oct. 14.

NAVAL.—Court, Montreal, on wreck of H.M.S. "Lily," reprimands Capt. Russell and 1st Lieutenant Hewitt, and dismisses them from ship.—Oct. 3.

Disasters, I. of Anglesea, H.M.S. gunboat "Enterprise" wrecked off.—Oct. 7.

Kiel, H.M.S. "Anson" goes ashore at.—Oct. 11.

Lord Chas. Beresford appointed to command of H.M.S. "Undaunted."—Oct. 27.

New York discovered that bottom of monitors Mountenmah and Tenor, are decaying in dock at New York.—Oct. 14.

New Brunswick, Hon. G. Turner, M.P., resigns his seat.—Oct. 12.

Newfoundland, new rock under water discovered off South Coast of.—Oct. 13.

New Guinea, I. of Dameria, Sir W. McGregor and 22 men have desperate fight with natives of.—Oct. 15.

New Guinea, advices to London detail massacre of Rev. Mr. Savage by natives of.—Oct. 30.

New York, Democratic Convention of, meet and favor tariff reform.—Oct. 1.

Niagara, Pan, Americans entertained at, by Mr. Wiman.—Oct. 14.

Nicaragua, canal difficulties regarding construction of, settled.—Oct. 10.

Night Schools, Montreal, Premier Mercier petitioned by deputation of workmen on subject of Free Night Schools.—Oct. 7.

North-West Territories, Regina, J. McCarty in N.W. Assembly moves for draft of a petition to Dominion Government for repeal of dual language section.—Oct. 18.

North-West Territories, Montreal, *L'Etendard* denounces abolition of French language in N.W.T.—Oct. 25.

North-West Territories, petition presented to North-West Legislature, asking permission to manufacture beer in N.W.T.—Oct. 25.

North-West Territories, Regina, Mr. Coyle's motion to abolish dual language in N.W.T. carried by N.W. Assembly at.—Oct. 28.

Ontario, Language question, Minister of Education issues order that English shall be language of instruction.—Oct. 21.

Ontario, booksellers of, pass resolution endorsing Canadian Copyright Act.—Oct. 31.

Ottawa, ex-Alderman Adam of, suddenly disappears.—Oct. 24.

Ottawa, Exchequer Court of Canada opens at.—Oct. 1.

Panama Canal, M. Prunet, liquidator of canal, announces that it is for sale.—Oct. 15.

- PAINE**.—Commission, London, Michael Davitt addresses, states he is not a Fenian now, owing to changed conditions.—Oct. 24.  
 Commission, London, Michael Davitt in address before, tells why he established Land League to abolish landlordism.—Oct. 29.  
 Commission, London, Michael Davitt concludes his speech before.—Oct. 31.
- Philadelphia**, Forestry Congress at, elect Hon. H. G. Joly as vice-president.—Oct. 19.
- Pittsburg, Pa.**, barb wire, manufacturers of, increase price of wire 5 per cent.—Oct. 19.
- Poisoning**, Woodbury, N.J., twenty people in boarding house at.—Oct. 15.
- PORTUGAL**, King of, reported dying.—Oct. 15.  
 Duke of Braganza issues proclamation assuming reins of power.—Oct. 19.  
 Chamber of Deputies, 102 Government supporters and 38 members of opposition elected.—Oct. 21.  
 Death of the King.—Oct. 19.  
 Portugal, Funeral of King of Portugal takes place at Lisbon.—Oct. 27.
- Pork**, Sawyer and Wallace, brokers of New York, obtain injunction restraining delivery of October pork on Board of Trade.—Oct. 4.
- Postal**, Washington, D.C., mutual arrangements made for transmission of articles through Canadian and U.S. mails.—Oct. 25.
- Postal**, Washington, D.C., conference of post office inspectors held at object to adopt better means to detect fraud.—Oct. 23.
- Prussia**, Government of, submit bill to Bundesrath, authorizing loan of 249,000,000 marks.—Oct. 11.
- QUEBEC**.—Government of, appoint Mr. Cloran to examine the jury system.—Oct. 4.  
 Federal Government decide to close Marine Hospital.—Oct. 23.  
 Premier Mercier expresses himself insulted by remarks made at labor congress, that he was fishing for votes.—Oct. 7.  
 Premier Mercier orders extensive report on toll gates and bridges.—Oct. 12.  
 Premier Mercier celebrates his 43rd birthday.—Oct. 16.
- RAILWAYS**.—Bavaria, Bill submitted to double track on all single track railways in.—Oct. 6.  
 Grand Trunk, Hon. F. Smith director of G. T. R. resigns.—Oct. 9.  
 Guatemala and Panama Canal Co. sign contract for construction of railroad establishing communication between Atlantic and Pacific Coasts across Guatemala.—Oct. 24.  
 Interstate Rapid Tram Co. placed in hands of a receiver.—Oct. 6.  
 London, Eng., syndicate to bridge River St. Lawrence at Quebec, and run railway to Belle Isle straits, formed in.—Oct. 23.  
 London, directors of G. T. R. hold meeting in.—Oct. 29.  
 Montreal, rumored that C. P. R. will take over Great Western R. R. from St. Jerome to Montserrat.—Oct. 2.  
 New York Jay Gould decides to entirely re-construct the Manhattan Elevated R. R.—Oct. 28.  
 New York, reported that Vanderbilts will take over the Chicago and Alton R. R.—Oct. 29.  
 Nicolet, P. Q., meeting held at, to discuss South Shore R. R. scheme.—Oct. 26.  
 Nicolet, P. Q., convention held at, to urge on Government the extension of Intercolonial R. R. along south shore from Pt. Levis to Montreal.—Oct. 26.  
 Northern Pacific R. R. authorizes issue of \$160,000,000 new 5 per cent. bonds.—Oct. 17.  
 Ottawa, R. R. Committee allow Northern Pacific to cross C. P. R. at Portage la Prairie.—Oct. 4.  
 Ottawa, Railroad Committee of Privy Council give several important discussions.—Oct. 16.  
 Ottawa, arrangements made for laying of first 30 miles of the Montreal and Western R. R.—Oct. 23.  
 Shanghai, China, stated that collapse of railway scheme, due to French influence.—Oct. 23.  
 Switzerland, concession applied for from Government of, for underground railway of Jungfrau mountain.—Oct. 23.
- RUSSIA**.—*Novel Vremya* states that if Germany wishes for peace, she should cease to tolerate Austrian intrigues in Bulgaria.—Oct. 11.  
*Novel Vremya* affirms friendship of Russia and Germany.—Oct. 15.  
 Stated that revenue for 1889 is 34,000,000 roubles in excess of expenditure.—Oct. 21.  
 Batoum, Russian warship sank at, crew lost.—Oct. 16.
- SAMOA**.—Public meeting held at, to elect a King.—Oct. 14.  
 Samoa, battle between forces of Mafetua and Tamusasa take place in.—Oct. 15.
- St. Louis, Mo.**, English Syndicate secures option in Elevator Co. of.—Oct. 4.
- Saxony, Government of, decide to admit women to privileges of the Universities.—Oct. 10.
- Servia**, Government of, abolish their own consulships in Germany.—Oct. 22.
- Servia**, Ex-King Milan expresses great confidence in regents.—Oct. 1.  
 Ex-King Milan telegraphs to regents of, asking that Queen Natalia should be granted an interview with her son.—Oct. 12.  
 Ex-King Milan denies a desire to resume power in.—Oct. 14.
- SHIPPING**.—British S.S. "Earmoor" founders, heavy loss of life.—Oct. 3.  
 Baltimore, Carl Graves and L. Loder, survivors of S.S. "Earmoor," tell how they sustained life by cannibalism.—Oct. 25.  
 British, S.S. "Bolton" from Calcutta to Liverpool founders at sea, 33 lives lost.—Oct. 28.  
 Behring Sea, Louis Bloss, Pres. of Alaska Commercial Co., states that 30,000 skins were stolen in, by pirates.—Oct. 11.  
 Collision S.S. "Geographique," collides with "Nova Scotia" and is lost.—Oct. 1.  
 Cullyhunk, Mass., schooner "Quill" lost near, crew drowned.—Oct. 16.  
 Halifax, "Geographique" collision, Capt. of "Minnie Swift" tell story of terrible cruelty.—Oct. 9.  
 Lake Erie, severe storm on, causes much wreckage.—Oct. 23.  
 Messrs. Allan issue contracts for building of three additional freight steamers for Canadian service.—Oct. 19.  
 New York, S.S. "Tentonia" and "City of New York" start on ocean race from.—Oct. 16.  
 Ocean race, S.S. "Tentonia" defeats "City of New York" on Western trip.—Oct. 12.  
 Ottawa, Collector of Customs refuses to allow American fishing schooner at Charlottetown to purchase sails unless absolutely necessary for homeward voyage.—Oct. 1.  
 Valencia, Brig "Zuleika" wrecked off, crew drowned.—Oct. 9.  
 Washington, D.C., Marine Conference, masthead and colored lights approved of by.—Oct. 22.
- St. Valier, P. Q.**, S.S. "Canopur" goes ashore at.—Oct. 2.
- Spain**, Papers of, commenting on International American Congress express hope that Spanish American Republics will not allow themselves to be made satellites of by U.S.—Oct. 3.
- Spain**, Madrid, a number of statesmen, generals, etc., arrested in gambling house.—Oct. 9.
- SPORTING**.—Shooting, Montreal, great telegraphic shooting match comes off at.—Oct. 7.  
 Bicycling, Peoria, Ills., fastest mile record of America made by R. Myers at time 2 min. 13 sec.—Oct. 14.  
 Football, Montreal, Sherbrooke defeat Capitals at, and win Intermediate championship.—Oct. 12.  
 Lacrosse, Montreal, Crescents of, defeat Independents of Quebec, and win Provincial championship.—Oct. 10.  
 Racing, London, objection lodged against awarding Czarwitsch stakes to "Primrose Day"—Oct. 16.  
 Racing, London, Eng., objection against "Primrose Day" winner of Czarwitsch stakes overruled.—Oct. 19.  
 Racing, Newmarket, Eng., Middle Park Plate won by "Signorina"—Oct. 9.
- RACING**.—Cambridgeshire, stakes won by "Laureate"—Oct. 23.  
 Sculling, London, Matterson beats Babear at.—Oct. 14.
- STANLEY M. H.**—Brussels, *Independence Belge* publishes account of his return to African coast.—Oct. 23.
- Berlin, news received at, of explorer's arrival at Mpwawa.—Oct. 23.  
 Zanzibar, Mr. Stephens, New York Herald commissioner, returns to, having failed to find explorer.—Oct. 27.
- STORMS**.—Great Britain, terrific gale sweeps over, causing much damage.—Oct. 7.  
 Storms, I. of Sardinia, great hurricane sweeps over.—Oct. 6.  
 Isle de Carmen, Mexico, great gale causes loss of 12 vessels, 2 steamers and 20 coasters.—Oct. 1.  
 Massachusetts, great gale on coast of, causes heavy damage.—Oct. 14.  
 Naples, Italy, almost inundated by floods.—Oct. 20.
- STRIKES**.—Amsterdam, dockmen arrange for a strike.—Oct. 4.  
 Antwerp, engineers of trans-Atlantic Steamers at.—Oct. 16.  
 London, 2,000 tramway employees demand shorter hours.—Oct. 4.  
 Belgium, miners of.—Oct. 30.  
 Mous, Belgium, 4,000 hands join strikers at.—Oct. 29.  
 Briatou, Eng., employees of hemp warehouses at.—Oct. 28.

STRIKES.—Continued.

Birmingham, Eng., National Conference of miners at, declares in favor of workingmen's day of 8 hours.—Oct. 11.  
 Bristol, Eng., laborers taken to replace 600 gas strikers are stoned.—Oct. 9.  
 Charleroi, Belgium, two thousand coal miners.—Oct. 18.  
 Chemnitz, worsted workers of.—Oct. 23.  
 Denver, Col., delegate of International Brotherhood of Locomotive firemen vote in favour of federation of labor, at.—Oct. 28.  
 Denver, Col., Chief Arthur of Brotherhood of Engineers opposes federation.—Oct. 30.  
 Durham, Eng., miners of Silksworth colliery.—Oct. 19.  
 Hamburg, Dock men.—Oct. 16.  
 Firemen of S.S. "Umbría" strike.—Oct. 13.  
 France, coal miners of, end.—Oct. 29.  
 Lens, France, 3,500 coal miners in.—Oct. 12.  
 Lens, France, 6,000 coal miners at, troops sent.—Oct. 15.  
 London, N. Tramway Companies of, concede 12 hours per diem to men.—Oct. 11.  
 Newark, N.J., Bakers of.—Oct. 11.  
 Pittsburg, Pa., moulders, for increase of 10 per cent.—Oct. 19.  
 Railroad, miners on Baie de Chaleur R.R. resume work.—Oct. 23.  
 Railroads, switchmen of Louisville, Nashville and Wisconsin Cent R.R.'s, for increase of wages.—Oct. 22.  
 Toledo, switchmen.—Oct. 11.

SPICED.—Brighton, Sir William T. Robertson, kills himself, at.—Oct. 6.  
 Switzerland, Council of State for Canton of Fribourg vote \$2,250,000 to found Catholic University.—Oct. 6.  
 Temperance, Montreal, sixth annual Convention of W. C. T. U. opens at.—Oct. 2.  
 Temperance, N. Dakota, prohibition carried in.—Oct. 6.  
 Ticonderoga, remains of Lord Howe found at.—Oct. 10.  
 Toronto, Board of Police Commissioners adopt by-law requiring news boys to take out licence, and prohibiting girls from selling papers on streets.—Oct. 15.  
 Toronto, Mr. Mulock, M.P., re-elected vice-Chancellor of University of.—Oct. 18.  
 Toronto, Mr. Laurier, in speech at Reform Club of, expresses wish that English and French Canadians know each other better.—Oct. 1.  
 Triple Alliance, Germany, *Fester Lloyd* states refusal of Sultan of Turkey to join Triple Alliance.—Oct. 23.  
 Troy, N.Y., great French Convention held at.—Oct. 14.  
 Tupper Sir Charles, visits Spain.—Oct. 14.  
 United States, Washington, D. C., Blaine and Windom quarrel over relations of U.S. and Mexico.—Oct. 14.  
 Acting Secretary Batcheller prohibits landing of Chinese laundrymen in U.S.—Oct. 29.  
 Washington, D.C., Negro preachers advise their race to move more South and West.—Oct. 20.  
 Washington, D.C., preliminary meeting of the Maritime conference held at.—Oct. 16.  
 Wilkesbarre, Pa., first American convocation of Grand Commandery of America and Ancient Rights of Malta takes place at.—Oct. 15.

Photo - Engraving.

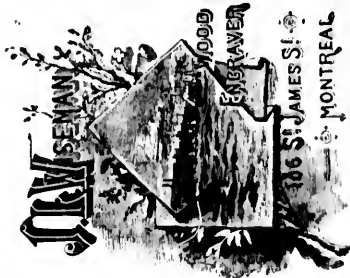

Pen Drawing & Map Etching.

COMPANION PICTURES.

Another handsome reminder of the continued enterprise of THE YOUTH'S COMPANION, the favorite family paper, has come to us in the form of a Colored Announcement Card, printed in fourteen colors. It is folded in the centre, and has on either cover companion pictures.

Spring is represented by a beautiful maiden who is returning through the fields, her hands filled with trailing arbutus—that delicate spring flower which grows so plentifully in many localities. On the companion page, the farmer's daughter is pictured coming through the harvested grain, carrying a well-filled pinner and basket. The bearer of the noon-day lunch is a welcome sight to the hungry reapers. The interior of the card contains an array of authors and articles for the coming volume unsurpassed by any paper.

This beautiful Card is only an indication of the great enterprise of THE COMPANION, which has made it a National Family Paper, with more than 430,000 subscribers. Nowhere can there be obtained so much entertainment and instruction for so little money. (Only \$1.75 a year).

If you subscribe now you will receive the paper free to Jan. 1, 1890, and for a full year from that date. The publishers offer to send specimen copies and this Colored Announcement Card free. Address THE YOUTH'S COMPANION, Boston, Mass.

WEBSTER

In various Styles of Binding, with and without Patent Index.

The Latest Edition has 118,000 Words, and 3,000 Engravings,—3000 more Words and nearly 2000 more Engravings than found in any other American Dictionary. It also contains a Biographical Dictionary, giving brief facts concerning nearly 10,000 Noted Persons. To these features we have

JUST ADDED (1885),

A NEW PRONOUNCING

Gazetteer of the World,

containing over 25,000 Titles,

briefly describing the Countries, Cities, Towns, and Natural Features of every part of the Globe.

WEBSTER IS THE STANDARD

Authority with the U. S. Supreme Court and in the Gov't. Printing Office, and is recommended by the State Super'ts. of Schools in 36 States, and by the leading College Presidents of the United States and Canada.

THE LONDON TIMES says: It is the best Dictionary of the Language. THE QUARTERLY REVIEW, LONDON, says: It is the best practical Dictionary extant.

THE CALCUTTA ENGLISHMAN says: It is the most important work of the kind.

THE TORONTO GLOBE, CANADA, says: Its place is in the very highest rank.

THE NEW YORK TRIBUNE says: It is recognized as the most useful existing "word-book" of the English language all over the world.

It is an invaluable companion in every school, and at every fireside. Specimen pages and testimonials sent prepaid on application.

G. & C. MERRIAM & CO., Publishers,

Springfield, Mass., U.S.A.

NEW YORK STOCK MARKET CLOSING QUOTATIONS.

OCTOBER.

Table of stock market closing quotations for October, listing various companies and their prices from Monday to Friday.

at.—Oct. 6. 2,250,000 to J. opens at newsboys papers on university.— with that —Oct. 1. n of Turkey marrel over laundrymen more South ference held mandary of Oct. 15. without 000 En- Engravings contains a rning nearly 5), orld, Natural ting Office, tea, and by a. Language. best practi- important e the very most useful eld. ry fireside .S.A.,



## TO ADVERTISERS.

### HOW TO GET THE MOST SERVICE FOR THE MONEY!

The Advertiser who would be willing to pay twenty-five cents for every family who could be "educated" up to the value of his goods would thus devote \$3,000,000 to educate the 12,000,000 families which make up the 50,000,000 people of the United States. This sum would do the business thoroughly in a year, for it is sufficient to pay for the insertion of a full column in every issue of every publication, and for resetting the matter, making it new in every issue of each separate publication. We will receive and execute the contract.

\$10.—We devote all necessary care to placing small orders for Advertising;—even the smallest! Time is saved by sending check with the order. Often the Advertiser is not possessed of sufficient information on the subject to enable him to judge of the merits of an estimate for advertising, and he decides by the feelings of the figures whether he will or will not do the work. Yet the estimate binds the Agent, and makes it improper for him to make any variation in its specifications, however much his judgment may point to material changes which ought to be made. This is specially liable to be the case when the order comes a considerable time after the estimate was made.

\$50.—If you are in the habit of occasionally inserting a small advertisement in a few papers, investing a few dollars, and carefully noting the result, we desire you to make trial of our Advertising Bureau, sending us the advertisement and the money, leaving the selection of the papers to us and judging of the service rendered by results rather than by names, circulation claims or prices. To make up careful estimates calls for much work. It does not pay to make them indiscriminately for every applicant. If such estimates are asked for were always given, the Advertiser who wished to expend \$50 would frequently find himself in possession of the scheme which it would cost \$500 or possibly \$5,000 to carry out.

\$100.—The Advertiser who sends his advertisements, asking for the best service possible for one hundred dollars, will often get from five to fifty per cent. more service for his money than he would had he required us to tell him in advance exactly what service we would promise; for when an estimate has been given its plan and specifications must, in a general way at least, control the advertising to be done. It ties the Agent's hands, and prevents his giving his patrons *to-day* a better service than he could have promised yesterday, because yesterday the opportunity had not presented itself: *to-morrow* it may have passed! Some publications are used most economically on contracts for a single issue; in others, insertion for a month may be had as cheaply as for a single week; but in furnishing an estimate in advance, if the Agent attempts to go into details, his correspondence becomes voluminous and the advertiser confused.

\$250.—Prepare a small advertisement and send with check for \$250, or any other sum. The practice of asking the Agent to name his papers in advance compels him to name such as are well known, otherwise there is reason to suspect that his judgment is biased;—and the best papers do not like to have their value quoted below their schedule.

\$500.—Leading newspapers, especially the leading Agricultural news papers, frequently issue large special editions (of twenty, fifty, one hundred or even five hundred thousand copies), and solicit advertisement orders from us, on terms which would often be accepted by our patrons if there was time to invite attention to the matter; but the question must generally be decided before there would be time to write and receive a reply, and often the case cannot be fully stated within the limits of a letter.

\$1,000.—If we are given authority to insert advertisements to a limited amount, in such mediums as offer inducements which seem to us specially favorable, we shall not abuse the confidence reposed in us, and shall render statements of whatever is done (if anything) from day to day. When *traded* with the placing of an advertisement, we are put upon honor, and are bound in honor to give the best service possible for the money to be used.

\$5,000.—One of the most successful Advertisers we ever had always ordered his advertisements in this way, "Get the best service you can for me for \$5,000," leaving every detail to us. We were thus enabled to say to a Publisher, if you put this in at a large reduction from your rate it will be no criterion for further transactions. It was a surprise to find ourselves so often able to contract for the insertion of that particular advertisement at half rates, in papers which would not permit us to offer their columns at a penny's deviation from their printed schedule. The advertising rate of one New York paper are double those of another which has twice the circulation of the first. Similar discrepancies are not uncommon. The advertisement entrusted to us to be placed in accordance with our judgment often does double service for half the money. A dollar for twenty-five cents.

The Oldest and Largest Roller Casting Establishment in New England.

ESTABLISHED 1859

# WILD & STEVENS.

MANUFACTURERS OF

Printers' Rollers and Roller Compositions.

No. 148 CONGRESS STREET, BOSTON.

## IT PAYS ADVERTISERS TO KEEP POSTED.



pays for a book of more than 200 pages devoted to Newspaper Advertising, and containing information valuable alike to experienced and intending advertisers.



pays for a year's subscription to **PRINTERS' INK**, a journal no advertiser alive to his own interests can afford to be without.

Issued twice a month and containing articles bearing on every branch in advertising; in fact the trade journal of American advertisers. A sample copy will be sent for Five Cents. Address

**GEO. P. ROWELL & CO'S**  
Newspaper Advertising Bureau,  
10 Spruce St., New York,

"I  
T  
not a  
but a  
subse  
delph  
Wor  
Toron  
Heru  
Jour  
Jour  
cago  
Press  
many  
these  
their  
INDEX  
include  
Counc  
Premi  
of Pub  
Hon. C  
zie Bow  
Secreta  
Inland  
Genera  
the Hon  
the Ho  
Quebec  
the Le  
Govern  
of Publ  
House  
many of  
Union  
public l  
Librari  
York, M  
brary, M  
Library,  
brarian  
E. Rich,  
The I

WHO SUBSCRIBE TO THE

## "INDEX OF CURRENT EVENTS."

The "Index of Current Events" is much appreciated not only by the press of Canada and the United States, but also by the public men of both countries. Its list of subscribers includes such great newspapers as the Philadelphia *Ledger*, the Boston *Transcript*, the New York *World*, the Cincinnati *Empire*, the Brooklyn *Eagle*, the Toronto *Empire*, the Cleveland *Leader*, the Chicago *Herald*, the Cincinnati *Post*, the New York *Morning Journal*, the Chicago *Daily News*, the Indianapolis *Journal*, the New York *Star*, the Troy *Budget*, the Chicago *Staats Zeitung*, the New York *Nation*, the Troy *Press*, the Washington *Star*, the Chicago *Inter-Ocean*, and many less known but important newspapers. Some of these papers are well known to keep admirable indexes of their own, yet find it advantageous to subscribe to the INDEX OF CURRENT EVENTS. We have the honor to include among our subscribers, Her Majesty's Privy Council for Canada; also, Sir John Macdonald, G. C. B. Premier of the Dominion, Sir Hector Langevin, Minister of Public Works, Sir A. P. Caron, Minister of Militia, the Hon. G. E. Foster, Minister of Finance, the Hon. Mackenzie Bowell, Minister of Customs, the Hon. J. A. Chapleau, Secretary of State, the Hon. John Costigan, Minister of Inland Revenue, the Hon. John Haggart, Postmaster General, the Hon. John Carling, Minister of Agriculture, the Hon. C. H. Tupper, Minister of Marine and Fisheries, the Hon. Commissioner of Agriculture and Colonization Quebec, the Hon. Boucher de La Bruère, late speaker of the Legislative Council, Quebec, the Hon. Lieutenant Governor Royal, Mr. Erastus Wiman, the Hon. Minister of Public Works, Toronto, The Librarian of Parliament, the House of Commons Reading Room and the Librarians of many of the Provinces of the Dominion and States of the Union subscribe to the *Index*. Among the well known public librarians who subscribe are, Mr. C. Hurlbut, Librarian of the American Geographical Society, New-York, Mr. W. A. Bardwell, Librarian of the Brooklyn Library, Mr. W. H. Brett, Librarian of the Cleveland Public Library, Mr. F. P. Jordan, Librarian of the Public School Library, Battle Creek, Michigan, Mr. W. T. Peoples, Librarian of the Mercantile Library, New-York, Mr. Robert E. Rich, Librarian of the Public Library, Portsmouth, N.

H., Mr. J. P. Dunn, Librarian of the Indiana State Library Indianapolis, Mr. F. W. Vaughan, Librarian of the Social Law Library, Boston, Mr. James G. Barnwell, Librarian of the Philadelphia Library, the Librarian of the Providence Public Library, the Librarian of the Free Public Library, San Francisco, Mr. John M. Doane, State Librarian of Ohio, Mr. William H. Egle, State Librarian of Pennsylvania, Mr. M. Chamberlain, Librarian of the Boston Public Library, Mr. A. W. Whelpley, Librarian of the Cincinnati Public Library and Mr. C. B. Tillinghast, State Librarian of Massachusetts. The leading bankers (including the Bank of Montreal), brokers, lawyers and hotel keepers of Canada, and many clergymen also keep the *Index* on file.

What is thought of the *Index* may be gathered from the numerous entirely unsolicited expressions of approval sent in by well known public men, of which the following are specimens:

MR. MARTIN J. GRIFFIN, LIBRARIAN OF PARLIAMENT, OTTAWA, writes:—I am sending you a subscription for two copies of your "*Index*," which will be most useful and which deserves encouragement. If you will take particular pains to give the dates and figures of elections and the dates of speeches of public men, with reference also to the place at which the speech was delivered, you will do a very grateful thing for public people and editors, and I may add librarians.

MR. JOHN M. DOANE, STATE LIBRARIAN OF OHIO, writes:—Enclosed please find six dollars, in payment for State Library subscription to the "*Index of Current Events*" for 1888.

I regard it as a very valuable publication, and hope that you may meet with such success as to warrant its continuance, for it will grow more valuable every year.

MR. HERBES, OF THE BROOKLYN *Eagle*, writes:—"I congratulate you most heartily upon having done a good thing, a very good thing, in starting the "*Index*" enterprise. I hope I may have the joy of congratulating you upon your success a year hence. A man with *Index* on the brain is one after my own heart. My judgment was formed upon Number 1; if the indexing is kept up as thoroughly in all subsequent numbers it will be a great help to us."

SIR CHARLES TUPPER, BARRISTER AT LAW, HIGH COMMISSIONER FOR CANADA, writes:—It seems to me to be a very useful publication, and one that will be valuable for reference purposes."

MR. BURK, ASSOCIATE EDITOR OF THE PHILADELPHIA *Public Ledger*, writes:—"Your *Index* is highly appreciated at this office, where it has long been a desideratum."

MR. COLQUHOUN OF THE "TORONTO *EMPIRE*," writes:—"Allow me to congratulate you most cordially upon your admirable *Index*." The idea and its execution are alike worthy of all praise."

MR. VALEN, OF THE "NEW-YORK *MORNING JOURNAL*," writes:—"I find the *Indices* of great value, saving, as they do, much valuable time in looking up important events."

MR. WILL A. WOODWARD, REC. SEC. MASS. PRESS ASSOCIATION, writes:—Enclosed please find subscription for one year for "*Index of Current Events*." I have examined the specimen sent me with much interest and do not hesitate to commend it as an invaluable assistant in the newspaper office. The amount of time and labor it is calculated to save, cannot be compensated by one hundred times its subscription rate.

Commencing with Vol. II No. 1 the dates given in the *Index* are the actual dates of the occurrences; not as formerly the dates of publication.

The *Index* is published four times a month; but to form a complete *Index* for the year it is necessary to preserve only the first issue in each month.

The intermediate issues contain the news of the current month to date.

The subscription is \$6 per annum, payable yearly or half yearly in advance. Remittances should be made to

HENRY DALBY,

P. O. Box 861,

MONTREAL, Que.

**ALBEMARLE HOTEL.**

EUROPEAN PLAN,  
Broadway, Fifth-ave. & 24th-st., New York.  
(MADISON SQUARE.)  
JANVRIN & WALTER, Proprietors.

**HOTEL KAATERSKILL,**

Catskill Mountains, New York,  
Largest and Finest Mountain Hotel in the world. Rates of board moderate.  
W. F. PAIGE, Manager.  
Kaaterskill P.O., Greene Co., New York

**WEST END HOTEL,**

LONG BRANCH,  
SEASON OF 1889.  
Cottages and Restaurant open Saturday, June 8th. Hotel opens June 22nd  
with improvements and additional attractions.  
D. M. & W. E. HILDRETH, Props

**ASTOR HOUSE,**

Broadway, New York.  
On the European Plan. Rooms \$1.00 and Upwards  
The accommodations of the Astor will be found first-class in every respect  
Elevator running night and day.  
F. T. KEITH, Manager. F. J. ALLEN, Proprietor.

**"THE BATES,"**

INDIANAPOLIS, IND.  
Rates, \$2.50 to \$5.00 per day.  
LOUIS REICHOUD, Proprietor.

**PARKER HOUSE,**

BOSTON.  
European Plan. 300 Rooms. \$1.00 and Upwards per day  
Café of unsurpassed excellence. Private dining rooms for dinner parties.  
E. O. PINSCHARD & CO., Proprietors

**TREMONT HOUSE,**

BOSTON  
THE "PALACE" HOTEL.  
JOHN A. RICE & CO.  
Prices, \$3.00 to \$5.00 per day. Special rates made by the week. Rooms  
single or en suite, with or without baths.  
MRS. JOHN A. RICE, Manager

**ALBION HOTEL,**

MARKET SQUARE, - - - TORONTO.  
The best dollar a day house on the continent. Fine rooms; good service  
every convenience. Centrally located for railways, steamboats and street  
cars.  
JOHN HOLDENESS, Proprietor.

**THE PALMER HOUSE,**

TORONTO,  
Corner King and York streets, Specially adapted for Commercial men,  
\$2.00 per day.  
J. C. PALMER, Proprietor.  
Also Kirby House, Brantford.

**ST. NICHOLAS HOTEL,**

EDWARD N. ROTH,  
CINCINNATI, OHIO.  
On the European plan. Location and service unsurpassed. Every modern  
improvement. Rooms, \$1.50 per day and upwards.

**GRAND UNION HOTEL.**

Opposite Grand Central Depot,  
NEW YORK.  
Six hundred rooms at \$1 a day and upwards. Restaurants at moderate prices.  
BAGGAGE TO AND FROM GRAND CENTRAL DEPOT FREE.  
W. D. GARRISON, Manager.

**GRAND HOTEL,**

Broadway, cor. 31st-st., New York.  
ON THE EUROPEAN PLAN.  
HENRY MILFORD SMITH & SON, Props.

**THE GRISWOLD,**

DETROIT, MICH.  
Located corner Griswold and Congress-streets. Newly furnished and refitted  
throughout.  
Rates, \$2 per Day.  
ALBERT MAXWELL, Proprietor. E. T. OSBORN, Manager.

**FOREST CITY HOUSE,**

CLEVELAND, OHIO.  
Best location in the city, and the only hotel fronting on the park. Nearest  
to public buildings, opera house, churches, etc. Street cars pass the house to  
all parts of the city, suburbs and depots. Rates, \$2.50 and \$3 per day.  
TERRILL & INGERSOLL, Proprietors.

**FIFTH AVENUE HOTEL,**

Madison Square, New York.  
The largest, best appointed and most liberally managed hotel in the city,  
with the most delightful and central location. Conducted by HUTCHCOCK,  
DARLING & CO., who first opened it to the public.

**THE WINDSOR HOTEL,**

DENVER, COL.  
Largest and most Elegant Hotel in the West.  
BUSH & MORSE, Proprietors.

**ADAMS HOUSE,**

Washington-st., Boston.  
ON THE EUROPEAN PLAN.  
Three hundred rooms. Private parlors, baths, etc. Best location in the  
city. A strictly first-class house.  
GEO. G. HALL, Proprietor.

**YOUNG'S HOTEL,**

On the European Plan.  
Head of State-st., Boston.  
Greatly enlarged and improved, and now offers superior accommodations for  
both ladies and gentlemen. Noted for the peculiar excellence of its cuisine.  
J. R. WHIPPLE, Proprietor.

**TOWER HILL HOTEL**

AND COTTAGES.  
NARRAGANSETT PIER, R.I.  
Season 1889 opens June 25th.  
CHARLES A. OAKES, New York Office, 145 Broadway, Room 39.

# THE INDEX OF CURRENT EVENTS.

VOL. II. No. 44.

MONTREAL, DECEMBER 6, 1889.

\$6.00 PER ANNUM.

## NOVEMBER

ACCIDENTS.—Abyssinia, General Baldessera resigns command of Italian troops in.—Nov. 8.  
 Blizzard, Colefax, N. W., reported that 35 men lost their lives in recent blizzard in.—Nov. 29.  
 Electricity, Harris Henry, of New York, killed by shock of.—Nov. 30.  
 Electricity, Providence, R. I., lineman T. McCarthy killed by live wire.—Nov. 23.  
 Explosion, Bochune, Russia, explosion in Konstantice petroleum pits 14 workmen killed.—Nov. 27.  
 Explosion, Bradford, Pa., of natural gas, kills two persons.—Nov. 22.  
 Explosion, Dayton, Ohio, natural gas killing 2 children, injuring many people.—Nov. 26.  
 Explosion, Duquesne, Pa., boiler in Steel Works at, killing 2 men.—Nov. 26.  
 Explosion, Friedrichshuette, Silesia, in dynamite factory, 20 killed.—Nov. 3.  
 Explosions, Hanan, Germany, eight persons killed, twenty-eight injured by explosion in Royal Powder Factory at.—Nov. 4.  
 Explosion, Hazelton, Pa., fire boilers explode in Pardee & Co.'s coal mines, killing 3 men.—Nov. 9.  
 Explosion, Oil City, Pa., three men killed and much property damaged by explosion of nitro-glycerine at.—Nov. 30.  
 Explosion, Parkensburg, W. V., fly wheels controlling machinery in Parkensburg Mill Co. explode, damage \$10,000.—Nov. 25.  
 Explosion, Philadelphia, terrific explosion occurs in Wylie & Wallace's chemical works at, killing 3 men.—Nov. 11.  
 Fall of belfry at Olahnalyfalo, Hungary, killing six persons.—Nov. 16.  
 Fall of building, Glasgow, fall of a gable wall kills over 50 girls and women in Templeton's Carpet factory.—Nov. 1.  
 Glasgow, twenty-nine bodies recovered from ruins of carpet factory.—Nov. 3.  
 Fall of building, Olahnalyfalo, Hungary, belfry falls, killing six persons at.—Nov. 15.  
 Fire, Baldensville, N. Y., Seneca Hotel at, loss \$250,000.—Nov. 20.  
 Fire, Boston, great blaze in, destroys many business houses, loss \$19,000,000.—Nov. 27.  
 Fires, Bo., loss in great fire estimated at \$11,000,000.—Nov. 28.  
 Fires, Chicago, large building in Fifth Avenue destroyed, estimated damage \$33,000.—Nov. 30.  
 Fire, Elmora, Assiniboia, coal fields in, reported on fire, some 200 feet deep.—Nov. 27.  
 Fire, Leechburg, Post Office and many buildings destroyed at, loss \$110,000.—Nov. 26.  
 Fire, London, Westwood, Baillie & Co., iron works destroyed by, loss \$250,000.—Nov. 1.  
 Fire, Lynn, Mass., square mile of business portion of, destroyed, loss \$10,000,000.—Nov. 26.  
 Fire, Lynn, Mass., \$30,000 subscribed for sufferers from late fire in.—Nov. 23.  
 Fire, Philadelphia, Janney & Andrews, loss \$200,000.—Nov. 23.  
 Fire, St. Eleno Co., four children burnt to death.—Nov. 16.  
 Fires, Toronto, Truth building damaged by, to extent of \$100,000.—Nov. 29.  
 Fire, Williamsburg, N. Y., Hector Iron Works in, damage \$250,000.—Nov. 25.  
 Flood, Alton, Ont., mill dam bursts at, carrying away several mills, two persons drowned.—Nov. 12.  
 Floods, Johnstown, Pa., flooded again.—Nov. 9.  
 Mining, Hutte, Mont., nine men suffocated.—Nov. 23.  
 Mining, Westphalia, Germany, 250 miners (entombed in) rescued.—Nov. 25.  
 Rauban, Germany, twenty miners burned by collapse of mine at.—Nov. 13.  
 Poisoning, City of Mexico, poison accidentally administered to inmates of Belem Hospital in, kills four persons.—Nov. 29.

## ACCIDENTS.—Continued.

Railway, Old Colony steamboat train in collision with switch engine of New York, Providence and Boston Road at Providence Rhode Island, two killed.—Nov. 30.  
 Railway, Easton, Cal., passenger train on N. Ford road collides with a freight, 3 men killed.—Nov. 1.  
 Railroad, Vaudrenil, P.Q., George Robinson, G. T. R. conductor, falls off bridge at, and is drowned.—Nov. 22.  
 Shooting, Montreal, Capt. Duchene of schooner "Albany" shoots himself.—Nov. 3.  
 AFRICA.—Statement that Lord Salisbury protested against German protectorate on coast of denied in London.—Nov. 4.  
 Lord Salisbury protests against German protectorate on East Coast of.—Nov. 3.  
 Wiseman's expedition encounters 6,000 Maftes, and repulses them with loss.—Nov. 4.  
 Zanzibar, report of massacre of Dr. Peters forwarded from.—Nov. 6.  
 Transvaal, great drought reported in.—Nov. 11.  
 Lieut. Gordon, leader of Portuguese expedition, announces submission of chiefs of Musbondland tribes to Portugal.—Nov. 9.  
 Zanzibar, German East Co. of, restore warehouses, etc., claimed by Sultan of.—Nov. 9.  
 Guinea, reported that Queoa war ended in favor of Portuguese.—Nov. 19.  
 Tunis, many prisoners and soldiers killed in revolt amongst convicts in Laytonville prison at.—Nov. 22.  
 London, Mr. McKinnon receives a letter of thanks from Emin Pasha acknowledging receipt of relief fund.—Nov. 25.  
 London Times says Stanley and Emin Pasha will enter British African Co.'s service.—Nov. 27.  
 Tajoroh ruler of, signs treaty for suppression of slavery.—Nov. 27.  
 Reported that Major Wissman's next undertaking will be an expedition to arrange matters in Usambura.—Nov. 29.  
 Lord Salisbury orders British Minister at Lisbon to protest against Portuguese annexation of territory north and south of Zambesi R.—Nov. 25.  
 Lisbon, Tapers of, severely condemn Salisbury's attitude on African affairs.—Nov. 27.  
 Agriculture, Quebec, Council of Agriculture advise closing of Richmond College.—Nov. 23.  
 Agricultural, Richmond, report of movement to establish College of Agriculture at.—Nov. 3.  
 Alberta, cattle from, bring a very high price in English market.—Nov. 1.  
 Anti-Jesuit agitation, Ottawa, Col. O'Brien addresses Orangemen at, The Jesuit Act condemned.—Nov. 5.  
 Armenia, Moussa Bey, Kurdish chief, charged with outrages on Christian in, imprisoned.—Nov. 19.  
 Armstrong Engineering and Shipbuilding Co. decide to increase capital stock to £1,600,000. Sir W. G. Armstrong in speech defends the 110 ton guns, and denounces the government test as unfair.—Nov. 2.  
 Astronomical, Warner observatory, U.S., Mr. Swift of, discovers a new comet.—Nov. 16.  
 AUSTRALIA.—N. S. Wales in reply to Governor's speech in opening Parliament houses adopt address, hoping for federation in.—Nov. 27.  
 AUSTRIA Hungary, Herr Jokal before Diet advocates closest union with Austria.—Nov. 26.  
 Vienna, Nugg Beckskerek, enquiry on large number of sudden deaths in Hungary, prove 38 poisoning cases.—Nov. 23.  
 Republic accepted by all the provinces of. Papal benediction conferred on new Government.—Nov. 24.  
 New Government adopts the old flag, France recognizes Republic.—Nov. 29.  
 Dom Pedro, ex-Emperor of Brazil, arrives at Lisbon.—Nov. 29.  
 Baltimore, Premier Mercier addresses R. C. Congress, dwells on affairs in Canada, annexation, states the general sentiment to be in its favor.—Nov. 11.  
 Banks, semi-annual settlement day of Bank of England.—Nov. 1.  
 Barnum, London, police refuse to allow Barnum's parade on eve of Lord Mayor's day.—Nov. 2.  
 Bavaria, Government of, decide to readmit the clergy of Redemptorist order.—Nov. 15.

- BEHRING SEA.**—Victoria, sealers of, present Lord Stanley with address showing their wrongs.—Nov. 4.
- Birmingham, Eng.**, Liberal Unionists and Conservatives meet to discuss latter's claim to additional parliamentary claim for borough of.—Nov. 4.
- Brixham, Devon**, statue commemorating landing of William of Orange unveiled at.—Nov. 5.
- BRAZIL.**—Great revolution takes place in.—Nov. 14.
- Don Pedro replies to Government order, stating he will resign throne and leave for Europe.—Nov. 16.
- Declared a Republic, Emperor Don Pedro deposed.—Nov. 17.
- Revolution in, accomplished, Minister of Marine shot, Don Pedro reported as a prime mover in his own deposition.—Nov. 21.
- Provisional Gov. of, issue decree proclaiming universal suffrage in.—Nov. 21.
- Belgium, Brussels**, Anti-Slave Congress opens in.—Nov. 18.
- Brussels**, Anti-Slavery conference at, decides that territorial questions are out of its competency.—Nov. 23.
- Brussels**, British plenipotentiaries submit to proposals of anti-slavery congress at, for suppression of slave trade on the seas.—Nov. 29.
- Bulgaria**, St. Petersburg, Czar in interview with Bulgarian ambassador presses his right to select head of Bulgarian Government.—Nov. 3.
- Calgary**, action taken by T. Ede against Commissioner Herchmer of N. W. M. P. for \$5,000 (assault).—Nov. 3.
- Canada, P. Q.**, Provincial Government decide to test rights of Federal authorities lands in.—Nov. 2.
- Canada, L. A.** Cattelier appointed Under Secretary of State at.—Nov. 29.
- Chicago**, last batch of breweries in, reported waiting purchase by English syndicate for \$4,350,000.—Nov. 26.
- Chicago**, natural gas discovered near.—Nov. 13.
- Chicago**, sixteenth annual Convention of W. C. T. U. held at.—Nov. 8.
- China** Government of, refuses to grant a concession for telegraph line from Siberia to Peking.—Nov. 21.
- Cliff dwellers**, S. Colorado, ruins of habitations of cliff dwellers discovered in.—Nov. 23.
- Coal, Pittsburg**, Coal Cos. of, reduce price of coal delivered at New Orleans 4 cents per barrel (unprecedented).—Nov. 26.
- Coal, Sharbot Lake, Ont.**, rich find of, near.—Nov. 23.
- Coal, Philadelphia**, price of advanced to \$2 per ton by Schuylkill shippers.—Nov. 2.
- CRETE.**—Outrages in, continue, three Christians arrested.—Nov. 4.
- Lord Salisbury receives despatch from British Consul in, stating that accounts of outrages were exaggerated.—Nov. 4.
- Troubles in, settled, trade resumed.—Nov. 8.
- Sultan of Turkey grants amnesty to insurgents.—Nov. 15.
- Constantinople, trial of Mussa Bey, for maltreating christians in Crete begun at.—Nov. 23.
- CRIME.**—Bigamy, Montreal, case of H. Melbourne opened at.—Nov. 4.
- Arson, Paris, Ky., business premises of T. H. Waller at, burned by incendiaries, damage \$20,000.—Nov. 30.
- Amsterdam, N. Y., D. Carmichael, business man of, steals \$110,000.—Nov. 12.
- Bigamy, Windsor, Ont., William Ware convicted of.—Nov. 21.
- Dynamite, Jackson, Mich., prisoners attempt to blow up jail at, with.—Nov. 15.
- Defaulter, Conshohocken, Pa., Cashier, Cresson, of Tradesmen's National Bank, defaults with \$99,000.—Nov.
- Forgery, London, Eng., E. N. Rolfe, a journalist, sentenced to 10 years penal servitude for forging a bill of exchange.—Nov. 26.
- Forgery, St. Paul, Minn., F. Quesnel arrested for forgeries amounting to \$15,000.—Nov. 23.
- Gambling, New York, police raid on the Louisiana, Little Havana and a German lottery.—Nov. 30.
- London, Mr. Labouchere speaks of the London scandals in connection with telegraph boys.—Nov. 14.
- London, Press of, comment freely on late scandal, strongly urging wholesale exposure of persons implicated.—Nov. 26.
- London, Prince of Wales insists on London scandal being exposed if necessary.—Nov. 21.
- London, Mr. Parke, editor of the *North London Press*, arrested for libel in connection with Cavendish Square scandal.—Nov. 23.
- Outrages, Cornwall, Ont., gang of desperadoes commit extensive outrages.—Nov. 23.
- Train robbery, Clocton, Indian Territory, Missouri, Kansas and Texas RR. express robbed of \$50,000 by ten men.—Nov. 24.
- Train robbery, Berwin Station, F. T., fifteen masked men rob South bound Santa Fé train of \$30,000 at.—Nov. 26.
- Cuba**, Government of, award building of new water works with an American firm for \$2,000,000.—Nov. 22.
- Customs seizure, at Quebec, of three whisky smuggling schooners.—Nov. 13.
- DEATHS.**—Martin Colonel, M. P. for Rimouski, Que.—Nov. 4.
- Blackford Lord.—Nov. 22.
- DEATHS—Continued.**
- Earl of Mountcashell.—Nov. 13.
- Jellett Ex-County judge R. P., Picton, Ont.—Nov. 21.
- Moffatt Capt. Joseph, at Cleveland, by drowning.—Nov. 30.
- Pendleton, U. S. ex-Minister, at Brussels.—Nov. 23.
- Rogers Geo., of the St. Mary Foundry, at Montreal.—Nov. 30.
- Rev. Mother St. Louis, Superioress of Good Shepherd Convent, Quebec.—Nov. 4.
- Warmbrunn, Silesia, Adolphe Henselt, famous pianist, at.—Nov. 8.
- Duluth, great fraud in real estate discovered \$337,000 fictitious transfers exposed.—Nov. 5.
- ECCLESIASTICAL.**—Baltimore, Archbishop Satalli, Papal delegate to Catholic Centennial, arrives at.—Nov. 3.
- Baltimore, R. Catholic centenary celebrated at.—Nov. 10.
- Baltimore, Md., Catholic Centennial, Premier Mercier eulogizes on Archbishop Carroll, defends Jesuit Estates Act, etc.—Nov. 12.
- Baltimore, Md., Daniel Dougherty opens Catholic Congress with speech on Independence of Holy See.—Nov. 12.
- Baltimore, Md., Catholic Congress, Premier Mercier's address on impartiality of French Canadians, treatment of Protestants and Catholics.—Nov. 12.
- Baltimore, Catholic Congress at, closes.—Nov. 12.
- Chicago, Second Annual Conference of Church of God in C. J. convened in Chicago.—Nov. 16.
- Halifax, N. S., Archbishop O'Brien of, advocates congress of English-speaking R. Catholics, stating that future of Church of Rome is in English-speaking Catholics' hands.—Nov. 29.
- Kansas City, seventy-first annual meeting of Missionary committee of the Methodist Episcopal Church held at.—Nov. 13.
- London, England, *Standard* says General Simmonds's mission to Vatican will be confined to church matters in Malta.—Nov. 28.
- Montreal, Rev. E. Owen, of St. Bartholomew's, resigns, on account of dispute on surplice question.—Nov. 24.
- Montreal, Miss Wood, niece of Rev. Edmund, takes the veil.—Nov. 21
- New York, Presbytery of, decide for revision of Presbyterian form of faith.—Nov. 4.
- Ottawa, prominent members of St. George's Church withdraw on account of chanting of "Kyrie."—Nov. 3.
- Philadelphia, Archbishop Ragan of, supports rights of Catholic writers to criticize faults of priests.—Nov. 15.
- Rome, papers of, state that Pope in view of his early decease has asked to be interred in Basilica.—Nov. 9.
- Rome, Special to London *Mail* from, states that appointment of General Simmonds as British envoy to the Vatican is regarded as first step towards renewal of official relations between England and the Vatican on Irish question.—Nov. 1.
- Rome, Gen. Sir J. L. A. Simmonds, British envoy to Vatican, arrives at.—Nov. 23.
- Rome, Jesuits in, resolve to recall members of their order from Brazil.—Nov. 29.
- Rome, The Civiltà Cattolica denies its statement that Vatican had palliat schemes of Government to infringe Papal Sec.—Nov. 3.
- Rome, the Pope orders that the property of all cardinals who die having no relations, shall be bequeathed to the Propaganda.—Nov. 26.
- Rome, reported that the Vatican will create a Patriarchate in Egypt, and an Apostolic Prefecture in the Aymlagas.—Nov. 21.
- Toronto, Diocesan Jubilee celebrated at.—Nov. 21.
- Toronto, Anglican Jubilee closes at.—Nov. 27.
- Toronto, Ont., eighth annual Convention of Baptist Congress of America held at.—Nov. 12.
- EDUCATIONAL.**—University of Pennsylvania adopt modified form of co. educational system.—Nov. 5.
- Washington, D. C., dedication of Catholic University of, takes place at.—Nov. 13.
- Baltimore, Mrs. C. Doonovan of, presents \$100,000 to Johns Hopkins University, to found chair of English literature.—Nov. 8.
- Baltimore University, R. Catholics of America raise \$50,000 to endow a chair in, to memory of Father Matthew.—Nov. 16.
- Manitoba, University of, establishes seven new professorships.—Nov. 16.
- Montreal, movement to endow Faculty of Applied Science in McGill College (cost \$100,000).—Nov. 27.
- St. Paul, Man., Indian Industrial School handed over to Church of England authorities.—Nov. 20.
- EGYPT.**—Prince of Wales visits Cairo, inspects troops, French press jealous.—Nov. 2.
- Reported that Oema Digna is collecting troops to advance north.—Nov. 8.
- Soukim, Bagburns ravage country, slaughtering and doing much damage.—Nov. 27.

**ELECTIONS.**—State Elections, great victory obtained by democrats.—Nov. 4.

Birmingham, Eng., Conservatives of, discuss their relations with Liberal Unionists, and decide to insist on larger representation.—Nov.

Brome, P. Q., a prohibitionist meeting held at, succeeded by an Equal Right one, former refuse to be identified with latter.—Nov. 9.

Brome Co., P. Q., Conservatives of, elect Mr. R. N. England as their candidate.—Nov. 14.

Brome Co., P. Q., Conservatives of, hold meeting, and condemn Mercier's Baltimore speech.—Nov. 19.

Brome, P. Q., E. S. Millimore presides over Liberal meeting, final appeals to electors made.—Nov. 27.

Brome Co., P. Q., Mr. England (Conservative) returned for, by majority of 132 votes.—Nov. 29.

Brome Co., P. Q., Mr. Duffy on his defeat.—Nov. 29.

Compton County, P. Q., Liberal-Conservative Association elect their officers.—Nov. 22.

England, Mr. Gladstone states that if elections were held in England, a Home Rule majority of 109 would be returned.—Nov. 29.

Fredericton, N.B., Scott Act sustained in, for fourth time, majority 68.—Nov. 27.

Germany, Social Democrats nominate 102 candidates. Nov. 27.

New York, Sixth Congressional District, Turner C. H., to House of Representatives.—Nov. 30.

N. Dakota, G. Pierce elected U. S. Senator for.—Nov. 20.

Rimouski, Que., L. N. Asselin, Conservative, and A. Tessier, Government supporter, nominated.—Nov. 27.

Rimouski, *Le Courrier du Canada* protests against means taken to return Mr. Tessier for Rimouski Co., condemning appeal to religious sentiments of electors made by Government.—Nov. 30.

Toronto, West York Convention endorse Mr. Meredith as their leader.—Nov. 21.

W. Middlesex, Ont. John Morgan, Conservative, nominated to oppose Hon. G. W. Ross.—Nov. 27.

Electricity, New York, current carried through telephone roasts horse knocks man senseless.—Nov. 4.

Electricity, New York, grand jury of, return presentment vs. Electric Light companies of, for tearing up streets promiscuously.—Nov. 29.

Elevators, London, Company formed with capital of \$2,500,000 to buy grain elevators of Chicago and Pacific R.R. Company.—Nov. 3.

Emigration, New York, commissioners of, notify S.S. Companies of a head tax of 50 cents per head on all aliens.—Nov. 1.

Engineers, opening session of the American Society of Mechanical Engineers held at New York.—Nov. 19.

Epidemics, diphtheria, Illinois, principal towns reported full of disease.—Nov. 27.

Equal Rights, Sutton, meeting of Association held at, Mr. G. W. Stephens and Dr. H. L. Davidson deliver addresses on church and State.—Nov. 11.

European war, American, Paris, Capt. E. L. Falinski, a Mexican explosive inventor, predicts great European war.—Nov. 5.

**EXHIBITIONS.**—Boston, National marine exhibition opens at.—Nov. 4.

Chicago, horses at show valued at \$2,500,000.—Nov. 5.

Montgomery, Ala., Pres. Harrison opens.—Nov. 5.

Montreal, Florists' and Gardeners' show opens at.—Nov. 5.

Exhibitions, Cologne, *Gazette* of, advocates holding of an exhibition in Berlin, like Paris one.—Nov. 21.

**FAILURES.**—Montreal, J. D. Davie, Vice-Pres. of Banque Ville Marie assigns, liabilities \$45,000.—Nov. 5.

Gle ceater, Mass., Mansfield James, & Sons, grocers; liabilities unknown.—Nov. 30.

Montreal, Dugal A. L., furrier Notre Dame St.; liabilities \$12,000.—Nov. 30.

Montreal, J. Reiplinger, furrier, liabilities \$75,000.—Nov. 5.

New-York, Aimes Publishing Co., liabilities \$11,000.—Nov. 22.

New York, suspension of Arthur & Ketchum in Stock Exchange announced.—Nov. 27.

New York, Stern & Stern, wholesale jewellers of; liabilities \$250,000.—Nov. 29.

Norwich, Ont., D. M. Donald, proprietor of Produce Co., etc.; liabilities \$50,000.—Nov. 25.

Oswego, lumbering firms of J. K. Post and James Moir.—Nov. 16.

Paterston, Geo. Frost & Sons, silk manufacturers.—Nov. 30.

Philadelphia, S. H. Sultzbach, retail clothing merchant of; liabilities \$150,000.—Nov. 21.

Pittsburg, Pa., Lawrence Bank.—Nov. 23.

Pittsburg, Long & Co., first meeting of creditors at; liabilities stated in debtors' statement at \$343,000.—Nov. 30.

**FAILURES.**—Continued.

Toronto, F. Kiernan & Co., grocers of; liabilities \$56,000.—Nov. 29.

Uxbridge, Ont., of Black & Co., bankers.—Nov. 21.

Vienna (Reported) Messrs. Kandler, bankers of; liabilities 100,000 florins.—Nov. 26.

Famine, Terrance Bay, N.S., many families starving through failure of fisheries.—Nov. 4.

Florida, unsold R.R. lands and various R.R. consolidated under Associated R.R. Land Department of Florida, bringing 6,000,000 acres of land under one management.—Nov. 1.

Florida, Union of Orange Growers consolidate with Florida Fruit Exchange.—Nov. 22.

**FRANCE.**—Pres. Carnot repeats his gift of 25,000 francs, for the poor of Paris.—Nov. 4.

Admiral Krantz withdraws his resignation as Minister of Marine.—Nov. 8.

Boulanger issues a manifesto to French people.—Nov. 11.

Chamber of Deputies, Mr. Floquet announces that 390 elections were valid.—Nov. 14.

Paris, Chamber of Deputies, Mr. Floquet elected provisional president of, sixty Boulangists arrested.—Nov. 12.

Chamber of Deputies, 150 protests against newly elected members of, lodged.—Nov. 13.

Chamber of Deputies valids election of 488 members.—Nov. 15.

Chamber of Deputies, Mr. Floquet elected President of, by 383 votes out of 400.—Nov. 16.

Chamber of Deputies, Mr. Floquet in speech before, declares France to be in a state of peace, prosperity and happiness.—Nov. 16.

Chamber of Deputies, Mr. Monjou resigns his seat in.—Nov. 20.

Chamber of Deputies, several members of, form an agricultural party.—Nov. 22.

Chamber of Deputies, M. Ferrail moves a grant of 750,000 francs to assist striking miners.—Nov. 25.

Chamber of Deputies invalids election of M. Armand.—Nov. 26.

Chamber of Deputies, bill brought before, proposing tax on ever-foreigner residing in, etc.—Nov. 27.

Election Bureau of, invalidates election of Boulanger and M. Naquet.—Nov. 22.

Havelaque, Mr. Goblet in speech at, states that real struggle of future would be reform of taxation.—Nov. 9.

Isle of Jersey, Boulangist meeting held at.—Nov. 11.

Paris, Leon Say, in speech at, favors conciliatory policy between Church and State.—Nov. 8.

Paris, reported that total number of visitors to Exhibition at, was 25,000,000.—Nov. 9.

Paris, great exhibition closes.—Nov. 19.

Paris, Pajal Nuncio in, instructed by Vatican to favor adhesion by Catholics to Conservative Republican party.—Nov. 20.

Paris, M. Clemenceau, that revision commission was not competent to annul Boulanger's candidacy was invalid, Bureau decide otherwise.—Nov. 27.

Paris, surplus in Budget for 1888 announced to be 40,000,000 francs.—Nov. 26.

Senate votes a navy credit of 58,000,000 francs.—Nov. 20.

Freemasonry, Quebec, Grand Master of, removes edict pronounced against Grand Lodge of England.—Nov. 2.

**GERMANY.**—Emperor William visits Sultan of Turkey, at Constantinople.—Nov. 3.

Budget, Committee of Reichstag approve foreign office change and formation of new mining staff in Africa, and a new colonial department.—Nov. 8.

Berlin, foot and mouth disease amongst cattle assumes serious proportions near.—Nov. 18.

Berlin, American Thanksgiving dinner held at U. S. Minister Phelps's residence.—Nov. 27.

Ninety-one social democrats put on trial at Elberfeld for belonging to secret societies.—Nov. 19.

Reichstag of reject the motion to rescind the law regarding importation of cattle.—Nov. 19.

Reichstag of, hold debate on Colonial policy of, Socialist bill accepted.—Nov. 26.

Reichstag of, grants appropriation for defensive purposes in W. Africa.—Nov. 29.

Gladstone W. E., at Southport, England, condemns Government for causing plan of campaign and other evils.—Oct. 23.

Gladstone Mr., London, rumor that Mr. Gladstone will not contest his seat in Parliament.—Nov. 23.

- Glasgow, boom in pig iron market collapses.—Nov. 14.
- Guatemala, despatches state that leader of insurrectionists and his sons were shot by order of Pres. Berrillo.—Nov. 2.
- Guatemala, minister in Washington denies that revolt took place in Guatemala.—Nov. 3.
- Guinea, Venezuelans attack British residents of Callao, after inflammatory speeches on boundary question.—Nov. 3.
- Guinness Sir Edward, gives £250,000 for erection of dwellings for laboring poor in London and Dublin.—Nov. 20.
- Harvard, Mass., Mr. Bourlnot, clerk of Canadian House of Commons, addresses students of, on political relations of U.S. and Canada.—Nov. 8.
- Hatfield, McCoy feud, Milton, W. Va., great bloodshed reported, troops called out.—Nov. 1.
- Havana, Cuba, Government of, award contracts for new water works to American firm for \$2,000,000.—Nov. 23.
- Hawaii, R. Wilcox, leader of insurrection in Honolulu, acquitted.—Nov. 23.
- Hicks-Beach Sir M., in speech at Bristol, upholds fusion of Conservative and Unionist parties.—Nov. 13.
- Hungary, Government of, purchase 10,000 taverns throughout country for school houses.—Nov. 12.
- Immigration, Atlanta, Convention of Knights of Labor propose presenting a bill to Congress, restricting immigration.—Nov. 26.
- Imperial Federation meeting in London.—Nov. 16.
- India, London, report that Lord Harris will succeed to the governorship of Bombay.—Nov. 5.
- India, Bombay, Lord Harris appointed Lt. Governor of.—Nov. 21.
- India, American missionaries in, complain of tax levied on their salaries by British Government.—Nov. 12.
- Indians, Ottawa, Miss F. Mercalo, an Indian lady, appointed to department of Indian affairs (first such appointment ever made).—Nov. 22.
- Ingersoll, Ont., Sir R. Cartwright, in speech at, criticizes Equal Rights agitation.—Nov. 12.
- IRELAND, Cork, Tenants Defence League established in.—Nov. 4.
- Mr. Balfour at Cabinet Council presents to Lord Salisbury a draft of a land scheme for demanding \$10,000,000 to deal with disaffected parts of.—Nov. 29.
- Belfast, Ireland, *News Letter* publishes an apology to Mr. Sexton, and pays him £500 damages.—Nov. 25.
- Belfast, statue of William III unveiled at.—Nov. 16.
- Dublin, Appal Court confirms sentences on Father O'Dwyer and seven others.—Nov. 4.
- Parnellite party collect £20,000 in Australia.—Nov. 1.
- Rev. Dr. O'Reilly, of I. N. L. of America, hands over collection made in America \$8,000.—Nov. 1.
- Stated that Pope abandoned his attempt to pacify Ireland, as clergy there resisted him.—Nov. 27.
- Iron, Glasgow, prices of warrants in Pig Iron market rise from 57s. 1d. to 58s. 9d.—Nov. 4.
- ITALY.—M. de Loncle in *Xieme Siecle* states that Italian Government held 80,000 troops in readiness to invade France anticipating a Boulangist victory in electoral campaign.—Nov. 5.
- Parliament of, opened by King Humbert.—Nov. 25.
- Rome, decree issued ordering an investigation into the municipal finances of.—Nov. 9.
- Japan, London *Herald* states the good prospects of English entering on treaty relations with Japanese Empire.—Nov. 4.
- Jeffersonville, Indiana, Union League at, burns an effigy of Pres. Harrison.—Nov. 12.
- JESUIT ESTATES, Montreal, Premier Mercier pays over the \$400,000.—Nov. 5.
- Alleged discovery of a letter from Hon. Mr. Chapleau, saying he was ready to settle the Estate question in a quiet way.—Nov. 20.
- Mr. Chapleau denies that he ever communicated with the Jesuit Fathers on Estate question.—Nov. 19.
- Premier Mercier asks Mr. Chapleau's leave to publish latter's letter on question of.—Nov. 23.
- Ottawa, *Le Canada* blames Jesuits for University troubles in Montreal.—Nov. 24.
- Hon. Mr. Chapleau denies existence of a letter written by him on question of settlement of.—Nov. 29.
- Hamilton, Ontario, Presbytery of, resolve that Jesuit question must be tested.—Nov. 20.
- JUDICIAL—Quebec, Chief Justice Sir A. Stuart resigns.—Nov. 15.
- Montreal Bar of, unanimously favor selection of Mr. Justice Johnson as Chief Justice.—Nov. 21.
- Quebec, Hon. J. Blanchet appointed to the bench.—Nov. 16.
- Kakabeka Falls, with water right, sold to American parties.—Nov. 15.
- Kansas City, three large breweries in, sold to English syndicate.—Nov. 12.
- Kingston, Ont., delegates to Municipal reform Convention at, instructed to vote for abolition of exemptions under 700 (excepting Government and municipal property, etc.).—Nov. 12.
- Kingston, Ont., Mr. Wiman speaks at length on trade relations between U.S. and Canada.—Nov. 23.
- Kingston, Ont., Gas Co. and Electric Light Co. of, amalgamated.—Nov. 23.
- Knights of Labor, Atlanta, Ga., general convention of, opens at.—Nov. 12.
- Labor, London, L. Gas Light Co. admits 700 employees to share of profits.—Nov. 16.
- Denver, Col., Locomotive Engineers refuse to adopt plan of federation.—Nov. 2.
- Langevin Sir Hector, in article in *Le Drapeau*, points out advantages to federation of the Empire.—Nov. 2.
- MONTREAL—Montreal Seminary sued by city to recover \$8,988.07.—Nov. 2.
- Bloomington, Ill., Supreme Court of State of, decide in case of city vs. Mrs. Washburne of Salvation Army, establishes right of cities to protect themselves against alleged objectionable practices of Salvation Army.—Nov. 26.
- London, Eng., Court of Queen's Bench at, refuses to grant Sir C. Russell's motion asking to set aside decision of the lower courts postponing libel suit vs. the *Times*.—Nov. 12.
- London, Lord Euston takes action against editor of *North London Press* for articles connecting him with recent scandals.—Nov. 20.
- Montreal, action of Judge Dugas vs. *Le Monde* for \$25,000 damages commenced.—Nov. 5.
- Montreal, Appeal in case of Nuns of Hotel Dieu, from decision of Mr. Justice Mathieu appointing a commissioner.—Nov. 6.
- New York, Judge Daniels (in case of People vs. North River Sugar Refining Co.) decides that the sugar trust is illegal.—Nov. 8.
- Ottawa, decision in case of Royal Electric Light Co. of Montreal, to annul Edison Co.'s patent for incandescent light given against former.—Nov. 27.
- Quebec, H. McFarlane, contractor, asks suit against Baie des Chaleurs R.R. for \$417,000.—Nov. 23.
- Sherbrooke, case of Hon. J. G. Robertson, plaintiff vs. Hon. G. Irvine to recover 46 prior lien bonds of Quebec Central R.R. due to him.—Nov. 1.
- Waterford, Ireland, Mr. Redmond, editor of *News*, sentenced to 3 months imprisonment for intimidation.—Nov. 29.
- Leeward Islands, Sir F. H. Smith, governor of, visits Ottawa with object of establishing closer relationship between islands and Canada.—Nov. 1.
- London, Gas Light Co. of, admits 700 of its employees to share profits.—Nov. 15.
- London, Lord Mayor Isaacs installed in office.—Nov. 9.
- London, Hon. J. Whitehead, ex-lord mayor of, made Baronet.—Nov. 3.
- London, prospects of Canadian Dead Meat Co. issued in capital \$300,000.—Nov. 23.
- London, Union men in Export Docks refuse to work unless company's permanent workmen join Union.—Nov. 4.
- London, Eng., syndicate of French capitalists offer £200,000 for Her Majesty's theatre in.—Nov. 22.
- Lorne Marquis of, at Dundee, Scotland, points out advantages of Central Government.—Nov. 4.
- MARRIAGES—Royal, St. Petersburg, betrothal of Czarwitch to Princess Margaret of Russia, stated at.—Nov. 5.
- London, Eng., betrothal of Princess Maud to Czarwitch reported.—Nov. 25.
- London, Eng., Lord Fitzmaurice to Miss O. Fitzgerald of New York.—Nov. 23.
- Marriage between Prince Ferdinand of Bulgaria to Princess d'Alençon abandoned.—Nov. 22.
- Mexico, Chamber of Deputies elect Senor Romero as president.—Nov. 1.
- Mier, Mex., battle between Mexican troops and custom guards occurs at, fifteen persons killed, two lynched.—Nov. 8.
- MILITARY—Montreal, suggestion by marksmen of, to establish a Dominion rifle league, favorably received throughout provinces.—Nov. 2.
- Germany, Reichstag adopts bill for organization to two new army corps.—Nov. 29.
- Germany, Government of, offer 1,000 marks yearly to sharpshooters volunteering for Africa.—Nov. 23.
- Italy, Government of, order 40,000,000 smokeless gunpowder cartridges.—Nov. 27.

## MILITARY.—Continued.

Nov. 15.  
 at, instructed  
 pting Govern-  
 tions between  
 gamate.—Nov.  
 pens at.—Nov.  
 o share of pro-  
 of federa-  
 advantages to  
 3,07.—Nov. 2.  
 in case of city  
 ight of cities to  
 ities of Salva-  
 o grant Sir C.  
 e lower courts  
 North London  
 is.—Nov. 26.  
 25,000 damages  
 decision of Mr.  
 th River Sagar  
 —Nov. 8.  
 of Montreal, to  
 given against  
 ies des Chaleurs  
 Hon. G. Irvine  
 R. due to him.  
 sentenced to 3  
 a with object of  
 and Canada.  
 share profits.—  
 t.—Nov. 3.  
 capital \$300,  
 eas company's  
 0,000 for Her  
 ges of Central  
 tch to Princess  
 cb reported.—  
 of New York.  
 ces d'Alençon  
 pt.—Nov. 1.  
 ards occurs at,  
 lish a Domin-  
 es.—Nov. 2.  
 wo new army  
 sharp shooters  
 powder cart-

Russia, Government of, form 3 flying mortar artillery parks, 2 field and 2 local mortar parks, and a new corps of frontier guards.—Nov. 20.  
 Russia adopts Lebel rifle and smokeless powder for army.—Nov. 9.  
 Winnipeg, Dominion Court of Revision at, decides that men serving in Infantry Schools may vote on question of income qualification.—Nov. 21.  
 Mining, Randolph, New York, rich silver vein struck, also gold, at Salisbury, N. C.—Nov. 16.  
 Moncton, N.B., Marine Prohibition Convention at, declare prohibition necessary.—Nov. 14.  
 Montana, Republican Toole elected as Governor.—Nov. 4.  
 Montreal, Bailiffs' Association petition Superior Court that 5 of petitioners members be disqualified.—Nov. 1.  
 Montreal, million dollar by-law for harbor improvements put down for amendment.—Nov. 4.  
 Montreal Street R.R. Co. decide to issue new stock.—Nov. 6.  
 Montreal, P.Q., Chas. Tibbault speaks on future of French Canadian race and Roman Catholic Church at.—Nov. 10.  
 Montreal, Harbor Police (after 40 years existence) disbanded.—Nov. 30.  
 Montreal, members of City Council start on Western trip tendered by C.P.R.—Nov. 29.  
 Montreal, night schools opened in.—Nov. 27.  
 Mormonism, McLeod, Man., leading elders from Salt Lake City visit.—Nov. 18.  
 Mormonism, Salt Lake City, women take oaths to avenge blood of Prophet Smith.—Nov. 23.  
 MURDER, Chicago, Cronin, jury Wiber disappears.—Nov. 1.  
 Chicago, Cronin, Burke identified as man who rented Carlson cottage.—Nov. 2.  
 Chicago, Cronin trial continued, Burke supposed to be the mysterious J. B. Simonds, and visibly affected by evidence elicited.—Nov. 2.  
 Chicago, Cronin, Kennedy refuses to defend Burke, Cronin's friends meet.—Nov. 3.  
 Chicago, Cronin, Mr. Baker arrives at, with valuable evidence against Burke.—Nov. 4.  
 Chicago, Cronin, witness Spellman contradicts his former statement regarding the murder.—Nov. 4.  
 Chicago, Cronin trial, Alex. Sullivan discharged on \$25,000 bail.—Nov. 3.  
 Chicago, Cronin trial, Chicago, G. Klahre testifies concerning tin box, blood-stained clothes produced in court.—Nov. 11.  
 Chicago, Cronin trial, Mr. Hoerbal testifies to having seen Dr. Cronin enter the Carlson cottage, and heard sounds of great struggle.—Nov. 12.  
 Chicago, Cronin trial, past history of Clan-na-Gael, evidence declared incompetent by Judge McConnell, prosecution closed.—Nov. 13.  
 Chicago, Cronin trial, Dr. Cross gives a new story of the murder.—Nov. 14.  
 Chicago, Cronin trial, defence on (alibi method), opened, attempts to disprove identification.—Nov. 15.  
 Chicago, Cronin trial, Dr. Cronin's clothing and surgical case discovered in sewer.—Nov. 8.  
 Chicago, Cronin, continuation of the enquete, interesting evidence given by a reporter, outline of proposed defence shown.—Nov. 16.  
 Chicago, Cronin, the Hoboken witness arrested, the defence charged with tampering with Mr. Hoerdel.—Nov. 22.  
 Chicago, Cronin, President Harrison's name introduced, evidence still equivocal, prosecutor called as witness for defence.—Nov. 19.  
 Chicago, Cronin trial, prosecution closed.—Nov. 26.  
 Chicago, Cronin trial, Dr. Cronin's knives shown in Court, State Attorney Longenecker commences summing up.—Nov. 29.  
 Chicago, Cronin Dr. State Attorney General concluded his address for prosecution, Judge Wing opens for defence.—Nov. 30.  
 Chicago, Cronin Dr. ex-Judge Longenecker concludes his address to jury.—Nov. 30.  
 Chicago, Frawley, whole family of Frawley murdered.—Nov. 23.  
 Durango, Col., Old Hatch, chief of Pintes Indians, and his mother.—Nov. 13.  
 Grand Rapids, farmer Westbrook living near, brains his wife, son and three daughters, and cuts his own throat.—Nov. 3.  
 Guelph, Ont., Harvey trial, several witnesses swear to insanity of prisoner.—Nov. 1.  
 Guelph, Harvey the murderer sentenced to death, to be hanged on 26th inst.—Nov. 2.  
 Guelph, Minister of Justice declines to recommend commutation of death sentence of Harvey.—Nov. 25.  
 Guelph, Ont., W. H. Harvey, murderer, executed at.—Nov. 29.  
 Guelph, Ont., inquest on remains of Harvey at, official expert executioner recommended.—Nov. 29.

## MURDER.—Continued.

Lexington, Ky., Cols. Swope and Goodloe kill each other at.—Nov. 8.  
 St. John, Grand Jury bring true bill vs. McDonald in candy poisoning case.—Nov. 23.  
 Toronto, female inmate of Insane Asylum kills another.—Nov. 5.  
 Yuma, Arizona, Sheriff Reynolds and deputy, killed by their Indian prisoners on route to jail.—Nov. 3.  
 Mowatt Hon. Oliver, addresses electors c' West Lambton on religious and French school question.—Nov. 9.  
 Musical, Italy, fiftieth anniversary of Verdi's first opera celebrated throughout.—Nov. 16.  
 Nanaimo, B.C., suicide of Peter Cameron at.—Nov. 30.  
 NAVAL, Ottawa, order issued by Council setting aside part of Esquimalt harbor for use of British war ships only.—Nov. 3.  
 London, new cruiser "Blake" launched at.—Nov. 23.  
 Rio Janeiro, two British war ships ordered to.—Nov. 24.  
 U.S. Navy to be supplied with Brown preamatic powder and new smokeless powder.—Nov. 26.  
 U.S. cruiser "Charleston" accepted by Government.—Nov. 1.  
 Navassa Riots, Baltimore, U.S. cutter "Ewing" arrives at bringing prisoners and details of Navassa riots.—Nov. 1.  
 Navigation, Mr. Tyrrell of the "Albert" denies that Hudson Strait's passage is impracticable.—Nov. 18.  
 New Orleans, defalcation of \$400,000 in "baby" bonds discovered.—Nov. 1.  
 New York, State Elections, Democrats gaining, admitted by Politician that Gov. Hill will be the next democratic candidate for President.—Nov. 6.  
 New York, municipal authorities of, pass by-law prohibiting street music.—Nov. 7.  
 Northwest Assembly introduces bill to disfranchise in election of mayors and councillors from those who are in arrears for taxes after Dec. 1.—Nov. 4.  
 North West Territories, Regina, strained relations between Lt.-Governor Royal and N. W. Assembly reported.—Nov. 16.  
 Nottingham, Eng., Conservative Conference held at, Lord Salisbury states that Gladstone's separation scheme were making no headway, also states he would not support the 8 hour bill.—Nov. 26.  
 Nottingham, Eng., Conservative conference at, approve of Lord Salisbury's social programme.—Nov. 27.  
 Oil advances to 112, highest point reached in 4 years.—Nov. 8.  
 Oil, boring for petroleum in Gaspé commenced.—Nov. 4.  
 Ontario, Toronto Mail states that Provincial Government will dissolve Legislature.—Nov. 3.  
 Ottawa, great orange demonstration held in.—Nov. 5.  
 PARNELL TIMES.—London, Sir Henry James, in speech before Parnell Commission, strongly condemns Parnellism.—Nov. 5.  
 Commission, London, Sir H. James in speech before, declares that vast sums in hands of Irish leaders had not been accounted for.—Nov. 19.  
 Commission, argument on behalf of Times concluded.—Nov. 21.  
 Commission closed.—Nov. 22.  
 Parnell Mrs., mother of Nationalist leader, reported to be in a destitute condition in.—Nov. 15.  
 Parnell Mrs., publishes a letter calling attention to her destitute state.—Nov. 26.  
 Philadelphia, public meeting to express sympathy to sufferers, by Russian Political Exile system, held at.—Nov. 26.  
 Portugal, Queen of, gives birth to a son.—Nov. 15.  
 Portage la Prairie, Man., at opening of Leasdowne College, Attorney Gen. Marten says separate school system will be abolished.—Nov. 12.  
 Postal, proposed to extend a free delivery of letters to all cities in United States having 5,000 inhabitants.—Nov. 9.  
 Postal, reported that Mexico Government will introduce phonographs into its post office.—Nov. 21.  
 Postal, U.S., chief P.O. inspector Rathbone issues his annual report, showing arrest during year of 801 persons for offences against P.O.—Nov. 26.  
 Prince Edward Island, Charlottetown, P.E.I., alleged shortage in Provincial Crown Lands Department reported from.—Nov. 26.  
 QUEBEC.—Senator Ross's will found unguised in an old portmanteau estate left to F. Ross.—Nov. 1.  
 Citizens of the *Baudieu* protest against annexation with.—Nov. 1.  
 Premier Mercier receives Papal Benediction from Rome.—Nov. 2.  
 Premier Mercier returns from Baltimore, says his speech there on Annexation was misrepresented.—Nov. 13.  
 60,000 gals. of American smuggled whiskey seized at.—Nov. 15.  
 Government enroll 41 additional Justices of the Peace.—Nov. 4.  
 Extensive whiskey smuggling in, reported by Mr. Cornellier.—Nov. 21.  
 Phenomenally low tide at, grounds all vessels.—Nov. 18.  
 Premier Mercier at Montreal speaks on Rimouaki election.—Nov. 16.



**QUEBEC.**—Continued.

N. B. Cormier appointed Legislative Councillor for Kennebec division.—Nov. 23.  
 Deputation of workmen ask Premier Mercler for night schools in.—Nov. 27.  
 Great storm in, causes much damage, leaves the city in darkness.—Nov. 27.

**RAILWAYS.**—Chicago, Report from, states that control of C. I. R. R. secured by Vanderbilts.—Nov. 4.

Atchison, Topeka & Santa Fé Railway Co., and auxiliaries, mortgage by, for \$150,000,000 to Union Trust Co. of New York, registered at Topeka, Kansas.—Nov. 30.  
 Car blockade over, on C.P.R.—Nov. 13.  
 Chicago, new trip rates in grain adopted by Board of Marine Underwriters of, between Chicago and ports on Lake Michigan.—Nov. 1.  
 Chicago and N.W. declare semi-annual dividend of 3 per cent.—Nov. 25.

Fast Mail service from Chicago to Pacific Coast inaugurated on Burlington R.R.—Nov. 15.  
 Great scarcity of freight cars on Canadian and American lines reported.—Nov. 2.

G. W. R. commence a span bridge over R. Nicolet, length 2,808 feet, height from water 68 feet.—Nov. 3.

Harrisburg, charter issued to Wilkesbarre and Williamsport R. R. Co. at, capital \$1,600,000.—Nov. 25.

Montreal, freight car blockade continues on many lines, particularly G.T.R.—Nov. 4.

New York High R. R. official states that N.Y.C. and H.R.R. will contribute \$775,000 to World's Fair of 1892.—Nov. 1.

New York, application of Rochester and Lake Ontario R.R., to discontinue work on its road during winter, refused by New York Board of R.R. commissioners.—Nov. 13.

New York, J. King re-elected president of Erie R.R., Board resolve to pay 6 per cent. on income bonds.—Nov. 26.

Nicolet, Que., meeting of delegates for construction of South Shore R.R. takes place at.—Nov. 2.

Ohio (city of), notice served by R.R. lines entering, that all oil shipments must be delivered to store houses in barrels.—Nov. 26.

Ottawa Government grant land to Manitoba and Southern R.R. and Coal Co., in Turtle Mountains.—Nov. 23.

Persia, Shah, of, orders construction of road from Meshed to Janan.—Nov. 9.

Santa-Fé, south bound train wrecked at, four passengers killed, many injured.—Nov. 3.

St. John, N.B., Intercolonial R.R., conductors, etc. forbidden to accept tickets issued by Halifax and St. John agents of C.P.R.—Nov. 1.

Sale of Forth Worth R.R. to Union Pacific R.R. announced.—Nov. 26.

Three Rivers, P.Q., reported that Besses Laurentides R.R. sold to N. Pacific for \$75,000.—Nov. 16.

Toronto, Justice Galt gives judgment in favor of G.T.R., in action taken by town of Hamilton to prevent a junction being formed between H. and N.W.R.R. and G.W.R.R.—Nov. 4.

Toronto, G. T. R. refused special rates for Merchants Day.—Nov. 16.

Reed Senator, elected at Washington for speakership of House of Representatives.—Nov. 30.

Romania, Parliament of, opened by King Charles.—Nov. 27.

RUSSIA.—Prince Louis Napoleon obtains commission as major in army of.—Nov. 4.

St. Petersburg, *Novae Vremya* of, criticizes Lord Salisbury's Guildhall speech.—Nov. 11.

Government of, abolish Provincial Council of nobles of Baltic province.—Nov. 29.

Merchants of, declare that English and German competition in Persia has ruined their trade.—Nov. 29.

St. Laurent, Man., half-breeds of, hold meeting and condemn proposed abolition of separate schools and dual language.—Nov. 12.

St. Louis, first session of National Silver Convention held at.—Nov. 26.

St. Louis, Mo., English syndicate purchases 18 breweries of, for \$2,500,000.—Nov. 29.

Salisbury Lord, at Guildhall.—Nov. 9.

Salt Lake City, startling disclosures made by ex-members of Mormon Church in court at.—Nov. 15.

Salvation Army, Swiss Government prohibit meetings of.—Nov. 3.

Samoa, natives of, submit dispute regarding election of King to powers (Berlin Conference).—Nov. 23.

Serbia, plot discovered to depose King Alexander.—Nov. 25.

SHIPPING.—Meyer Head, Ireland, British SS. "Queensmore" sinks off crew saved, cargo valued at \$532,000 lost.—Nov. 8.

Eureka, Cal., schooner "Fidelity" lost near, captain and 8 men drowned.—Nov. 16.

**SHIPPING.**—Continued

"Germania" barque, report of coroner's jury at Long Branch on loss of.—Nov. 30.

Long Branch, coroner's jury on loss of barque "Germania," report of.—Nov. 30.

Liverpool, fire on S.S. "Alaska" destroys 500 bales of cotton.—Nov. 16.

New York, SS. "Santiago" arrives from Nassau, making quickest passage on record, 3 days, 7 hours.—Nov. 15.

Oregon, tug "Fearless" wrecked off coast of, six persons drowned.—Nov. 20.

SS. "Edith Gadden" founders at sea.—Nov. 23.

Yokohama, SS. "China" goes ashore at.—Nov. 23.

Serbia, Czar writes to Ex-Queen Natalie expressing sympathy, and recognizing her as Queen of Serbia.—Nov. 4.

Silesia, Socialists of, decide to enter candidates for Reichstag.—Nov. 12.

SMUGGLING.—Royal Oak, Mich., H. Durand, famous opium smuggler, captured.—Nov. 1.

Canadian smuggler returns \$2,500 to Government per Evangelist Moody.—Nov. 4.

SPORTING.—Derby, Eng., O. S. Maston's nursery won by "Ox eye."—Nov. 14.

Football, Brooklyn, N.Y., the Adelphi Academy beats the Columbia Grammar School in first game of International Scholastic football series for the season.—Nov. 30.

Football, Medea, Pa., Princeton's Reserves vs. Shortledge Medea Academy.—Nov. 30.

C. V. R. R. sue "Le Trappeur and Le Canadien" snow shoe clubs for \$560.00.—Nov. 21.

Racing, Clifton, N.Y., races at.—Nov. 30.

Racing, Manchester, Eng., November handicap won by "Fallow Chat" Conservator second.—Nov. 23.

Racing, Manhattan Club track, Thomas beats all previous records on 15 mile track, time 1 hr. 27 min.—Nov. 30.

Racing, New Orleans, winter meeting of New Louisiana Jockey Club at.—Nov. 30.

STANLEY H. M.—Letters received from, state he expected to arrive in Mpwapwa this month.—Nov. 3.

Emin Bey, relief committee receive letter from, with account of his discovery of Emin Pasha, etc.—Nov. 3.

New York *Herald* sends expedition to meet, escorted by Capt. Wissman.—Nov. 12.

Emin Pasha, relief committee order Capt. Wissman to despatch a caravan to relieve.—Nov. 13.

Arrives at Nijwapa bringing news of Emin Bey, Mahdi defeated, missionaries in danger.—Nov. 20.

Reports that he has discovered a large extension of Lake Nyassa.—Nov. 20.

Captain Wissman receives a letter from, giving account of his march.—Nov. 21.

Writes the history of his past year's work to Mr. McKinnon.—Nov. 23.

Mr. McKinnon receives another letter from.—Nov. 26.

Mtotoi, French mission caravan meet explorer at.—Nov. 26.

Great need of clothing reported by Nelson.—Nov. 27.

Sells his forthcoming book to Sampson Law Co., of London, for £40,000 sterling.—Nov. 29.

STORMS.—Denver, Col., disastrous snow storm does much damage and cuts off R.R. communication.—Nov. 2.

Colorado, many cow boys and thousands of cattle frozen to death by blizzard.—Nov. 9.

Newburne, N. J., hurricane nearly demolishes town.—Nov. 21.

Prince Edward Island, several schooners wrecked off coast of.—Nov. 29.

Snow, New Mexico, raging for 3 weeks, many lives lost, railways blockaded, etc., etc.—Nov. 5.

Tolson, N.M., three men frozen to death in, blizzard at.—Oct. 28.

Stowe Mrs. H. B., authoress of "Uncle Tom's Cabin," becomes hopelessly demented.—Nov. 20.

STRIKES.—Antwerp, of dock laborers.—Nov. 3.

Bristol, Eng., 7,500 dock and lightermen at.—Nov. 27.

Bristol, Eng., dockmen accept Mayor's offer to arbitrate.—Nov. 29.

Clyde engineers resume work.—Nov. 29.

England, demands of striking bakers acceded to by master bakers.—Nov. 16.

Glasgow, Scotland, steamer hands at.—Nov. 12.

Glasgow, Scotland, 12,000 Clyde engineers.—Nov. 26.

London, Lightermen of, decide to strike for advance in wages.—Nov. 1.

London, another strike of dock laborers narrowly averted by dismissal of non-union men and adoption of 6d. rates.—Nov. 4.

STRIKES.—Continued.

London, Thames lightermen decide to strike.—Nov. 4.  
 London, Lord Mayor invites striking lightermen to meet Cardinal Maoning at Mansion House.—Nov. 8.  
 London, J. Burns addresses striking bakers.—Nov. 9.  
 London, Eng., master lightermen concede to demands of strikers.—Nov. 9.  
 London, Eng., working day of ten hours conceded to bakers of.—Nov. 13.  
 Paris, 500 men on Western R.R. Co., for higher wages.—Nov. 26.  
 Pittsburg, moulders' strike decided in favor of men.—Nov. 4.  
 Spring Valley, Ill., miners' strike settled.—Nov. 4.  
 Vienna, ir. mother of pearl button factories, 4,000 hands out.—Nov. 20.

SUICIDE—Stratford, Ont., R. Potton, foreman of G.T.R.R. works, bangs himself.—Nov. 4.  
 Amsterdam, Herr Brandt, Danish consul at, commits.—Nov. 12.  
 Huntington, Ind., Rev. E. Delmora shoots himself at.—Nov. 29.  
 Nanaimo, B.C., Peter Cameron poisons himself at.—Nov. 30.  
 Switzerland, Bern, Federal Assembly meet, President speaks of existing friendly between Snderland and other States.—Nov. 25.  
 Theatrical, Chicago, Lillian Russell elopes with Mr. Sanford.—Nov. 15.  
 Tonkin, Sister Marie Thérèse receives cross of Legion of Honor.—Nov. 4.  
 Toronto, meeting of mayors and reeves of Ontario discuss the exemption question.—Nov. 12.  
 Toronto, Sir A. P. Caron speaks on state of the country at review of police of.—Nov. 11.  
 Toronto, Archbishop Walsh stoned in, on occasion of visit.—Nov. 27.

Turkey, St. Petersburg, *Novoe Vremya* of, states that Turkey has joined the Dreibund.—Nov. 9.  
 Turkey, Sultan of, bestows high decorations on Governor of Paris and chief of staff of French Army.—Nov. 1.  
 Turkey, Emperor William confers decoration of Black Eagle on Raemal Pasha.—Nov. 3.

UNITED STATES.—Revenue for fiscal year ending June 30th announced to be \$387,050,158, expenditure \$299,288,978.—Nov. 9.  
 Congress, Senator Reed elected speaker of House of Representatives by Republican Congress at.—Nov. 30.  
 Turner C. H., election to Congress.—Nov. 30.  
 Washington, Beef, Senator Vest's committee on dressed beef resumes selling at.—Nov. 30.  
 Washington, D.C., Senator Farrell announces his intention of introducing bill to abolish Civil Service examinations.—Nov. 23.  
 Washington, D. C. T. J. Morgan, commissioner of Indian affairs, states that reservation system must cease and Indians become American citizens.—Nov. 11.  
 Washington admitted to Union.—Nov. 11.

Venezuela, report received at Washington of revolution in Venezuela, on Oct. 26.—Nov. 16.  
 Winan Erastus, addresses Young Men's liberal club.—Nov. 1.  
 Winnipeg, N.W. Assembly resolved in, to ask C.P.R. to issue passes for immigration purposes.—Nov. 9.  
 Wool, Pennsylvania, Wool Growers' Association adopt resolutions protesting against classifying of wool as raw material.—Nov. 26.  
 World's Fair, New York, subscription on Nov. 2nd \$2,004,814.—Nov. 3.

WHEN  
 YOU \* ARE \* READY  
 To order any more  
**BINDING**  
 PLEASE CALL UP  
 TELEPHONE \* 230  
 Or send a POSTAL CARD to  
**JOHN LOVELL & SON,**  
 23 & 25 St. Nicholas St., Montreal.

Photo - Engraving.  
 Pen Drawing & Map Etching.

1000  
 ENGRAVER  
 106 St. James St.  
 MONTREAL



John Lovell, publisher of the Dominion Directory in 1871, at a cost of over \$80,000, now issues the

PROSPECTUS OF LOVELL'S  
GAZETTEER AND HISTORY

OF EVERY

COUNTY, DISTRICT, PARISH, CITY, TOWNSHIP, TOWN,  
VILLAGE, ISLAND, LAKE AND RIVER

IN THE EIGHT PROVINCES OF THE DOMINION OF CANADA.

IN ELEVEN VOLUMES.

Subscription to the Eleven Volumes, bound in full cloth, Gilt.....	\$75 00
" Ontario or Quebec, 2 Vols. each, with a Map.....	12 50
" New Brunswick or Nova Scotia, with a Map.....	11 50
" Manitoba or British Columbia, with a Map.....	9 50
" Prince Edward Island or Northwest Territories, with a Map.	
" Eleventh Volume. It will contain a concise History of the Dominion of Canada, Eight Beautiful Maps, List of Lakes, Rivers, Post Offices, &c.....	20 00

EACH PROVINCE, ALPHABETICALLY ARRANGED, WILL BE COMPLETE IN ITSELF.

Royal 8vo. size. All the volumes to be bound uniform in full cloth, Gilt.

The object of the work is to give, from the lips of the oldest inhabitants, or from other sources, a history of over 10,000 counties, districts, parishes, townships, cities, towns and villages, with descriptions of more than 3,000 islands, lakes and rivers, in the Dominion of Canada.

MONTREAL, Oct., 1889.

JOHN LOVELL, *Publisher.*

Alden's Manifold Cyclopaedia.

America and Artemis are the beginning and ending of the second volume of Alden's Manifold Cyclopaedia, which, even better than the first, fulfils the promises of the publisher's prospectus. It is a really handsome volume of 640 pages, half Morocco binding, large type, profusely illustrated, and yet sold for the price of 85 cents; cloth binding only 60 cents—postpaid. Large discounts even from these prices are allowed to early subscribers, the price being gradually advanced as the work progresses; particulars sent on request.

The Manifold Cyclopaedia is, in many ways, unlike any other Cyclopaedia. It undertakes to present a survey of the entire circle of knowledge, whether of WORDS or of THINGS, thus combining the characteristics of a Cyclopaedia and a Dictionary, including in its vocabulary every word which has any claim to a place in the English language. Its form of publication is as unique as its plan—the "Ideal Edition" its publisher calls it, and the popular verdict seems to sustain his claim. It certainly is delightfully convenient. It will not be strange if this proves to be the great popular cyclopaedia. It certainly is worthy of examination by all searchers after knowledge. The publisher sends a specimen volume on receipt of price, to be returned if not wanted. JOHN B. ALDEN, Publisher, New York, Chicago, or Atlanta.

READY, RAPID & RELIABLE FIRE ESCAPE.

The Best, Safest and Quickest Means of Emptying School and other Dormitories in Case of Fire.

The accompanying cut exhibits the essential features of the contrivance, which may be adapted either to the interior or to the exterior of a building, but preferably to the latter, so as to create no draught for flame or smoke. *C c* represent the floor, or, as in the present diagram, platforms, which may assume the form of an ornamental balcony. These platforms are secured to the walls by suitable brackets *e e*. Two vertical shafts *f f* pass through the

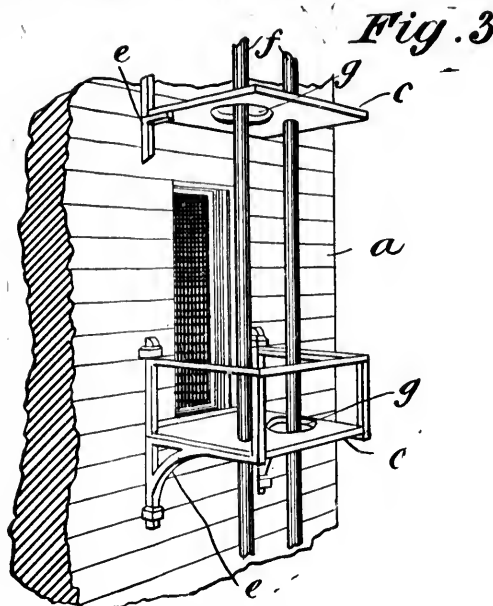

floors or staging from the roof to the ground; *g g* are circular openings which alternate from one side to the other at each succeeding landing. The landing to be placed before a window at every story.

The shaft to the left of *f*, and which is secured to the next platform above (not shown in the figure), is firmly clasped, not with the hands, but with the legs and arms, and the person slides down the shaft to the next landing below, regulating with ease, by the pressure of his limbs, the rapidity of the descent.

Inventor and Patentee,  
Rev. ARTHUR JONES,  
St. Mary's College, MONTREAL.

## TO ADVERTISERS. HOW TO GET THE MOST SERVICE FOR THE MONEY!

The Advertiser who would be willing to pay twenty-five cents for every family who could be "educated" up to the value of his goods would thus devote \$3,000,000 to educate the 12,000,000 families which make up the 60,000,000 people of the United States. This sum would go the business thoroughly in a year, for it is sufficient to pay for the insertion of a full column in every issue of every publication, and for resetting the matter, making it new in every issue of each separate publication. We will receive and execute the contract.

\$10.—We devote all necessary care to placing small orders for Advertising—even the smallest! Time is saved by sending check with the order. Often the Advertiser is not possessed of sufficient information on the subject to enable him to judge of the merits of an estimate for advertising, and he decides by the footings of the figures whether he will or will not do the work. Yet the estimate binds the Agent, and makes it improper for him to make any variation in its specifications, however much his judgment may point to material changes which ought to be made. This is specially liable to be the case when the order comes a considerable time after the estimate was made.

\$50.—If you are in the habit of occasionally inserting a small advertisement in a few papers, investing a few dollars, and carefully noting the result, we desire you to make trial of our Advertising Bureau, sending us the advertisement and the money, leaving the selection of the papers to us and judging of the service rendered by results rather than by names, circulation claims or prices. To make up careful estimates calls for much work. It does not pay to make them indiscriminately for every applicant. If such estimates as are asked for were always given, the Advertiser who wished to expend \$50 would frequently find himself in possession of the scheme which it would cost \$500 or possibly \$5,000 to carry out.

\$100.—The Advertiser who sends his advertisements, asking for the best service possible for one hundred dollars, will often get from five to fifty per cent. more service for his money than he would had he required us to tell him in advance exactly what service we would promise; for when an estimate has been given its plan and specifications must, in a general way at least, control the advertising to be done. It ties the Agent's hands, and prevents his giving his patrons *to-day* a better service than he could have promised yesterday, because yesterday the opportunity had not presented itself: *to-morrow it may have passed!* Some publications are used most economically on contracts for a single issue; in others, insertion for a month may be had as cheaply as for a single week; but in furnishing an estimate in advance, if the Agent attempts to go into details, his correspondence becomes voluminous and the advertiser confused.

\$250.—Prepare a small advertisement and send with check for \$250, or any other sum. The practice of asking the Agent to name his papers in advance compels him to name such as are well known, otherwise there is reason to suspect that his judgment is biased;—*and the best papers do not like to have their rates quoted below their schedule.*

\$500.—Leading newspapers, especially the leading Agricultural newspapers, frequently issue large special editions (of twenty, fifty, one hundred or even five hundred thousand copies), and solicit advertisement orders from us, on terms which would often be accepted by our patrons. If there was time to invite attention to the matter; but the question must generally be decided before there would be time to write and receive a reply—and often the case cannot be fully stated within the limits of a letter.

\$1,000.—If we are given authority to insert advertisements to a limited amount, in such mediums as offer inducements which seem to us specially favorable, we shall not abuse the confidence reposed in us, and shall render statements of whatever is done (if anything) from day to day. When *trusted* with the placing of an advertisement, we are put upon honor, and are bound in honor to give the best service possible for the money to be used.

\$5,000.—One of the most successful Advertisers we ever had always ordered his advertisements in this way, "Get the best service you can for me for \$5,000," leaving every detail to us. We were thus enabled to say to a Publisher, if you put this in at a large reduction from your rate it will be no critic! For further transactions. It was a surprise to find ourselves so often able to contract for the insertion of that particular advertisement at half rates, in papers which would not permit us to offer their columns at a penny's deviation from their printed schedule. The advertising rate of one New York paper are double those of another which has twice the circulation of the first. Similar discrepancies are not uncommon. The advertisement entrusted to us to be placed in accordance with our judgment often does double service for half the money. A dollar for twenty-five cents.

The Oldest and Largest Roller Casting Establishment in New England.

ESTABLISHED 1859

WILD & STEVENS,

MANUFACTURERS OF

Printers' Rollers and Roller Compositions,

No. 148 CONGRESS STREET, BOSTON.

**IT PAYS  
ADVERTISERS  
TO KEEP POSTED.**



pays for a book of more than 200 pages devoted to Newspaper Advertising, and containing information valuable alike to experienced and intending advertisers.



pays for a year's subscription to **PRINTERS' INK**, a journal no advertiser alive to his own interests can afford to be without.

Issued twice a month and containing articles bearing on every branch in advertising; in fact the trade journal of American advertisers. A sample copy will be sent for Five Cents. Address

**GEO. P. ROWELL & CO'S  
Newspaper Advertising Bureau,  
10 Spruce St., New York.**

# THE INDEX OF CURRENT EVENTS.

VOL. II, No. 48,

MONTREAL, JANUARY 6, 1890.

\$6.00 PER ANNUM.

## DECEMBER

Abyssinia, Aretoto, King Menelik and Queen Taitri crowned Nov. 3. Reported Dec. 23.

**ACCIDENTS.**—Asphyxiation by gas, Elgin, Illinois, John Stapleton, wife and grandson.—Dec. 2.

Asphyxia, Bethlehem, Penna., Jones J. P. and Palmer W. H., of Langor, from blowing out gas in room.—Dec. 26.

Asphyxia, Dewitt Mr., Syracuse, N. Y., Sarah Remeritt and Charlotte Thompson, by gas.—Dec. 25.

Asphyxia, San Francisco, Mrs. Irwin and her two daughters, of Denton county, Missouri, suffocated by gas in their bedroom.—Dec. 29.

Asphyxia, San Francisco, Captain Freeman, surveyor for Lloyds, and F. R. Canton, grain inspector, smothered in hold of British ship "Durham."—Dec. 20.

Burial, Bourbon, Ill., board-ley Samuel, from his clothes igniting whilst in fancy dress costume.—Dec. 24.

Holling, Kokomo, Indiana, John Starke, farmer, left by attendant in hot bath, boiled to death.—Dec. 27.

Drowning, Augusta, Me., Margaret, daughter of Major D.E. Michaelis.—Dec. 1.

Drowning, Mare Island, California, three sailors and a newsboy drowned by capsizing of a boat.—Dec. 23.

Drowning, Stanford, Ill., Mrs. John Stawbaugh and child.—Dec. 3.

Drowning, Werden, Rhensish, Prussia, three men drowned whilst skating.—Dec. 25.

Drowning, Wilkesbarre, Thomas Baucher drowned by capsizing of boat.—Dec. 21.

Electricity, Minneapolis, Minn., coroner's jury on bodies of victims of fire in *Tribune* office recommend that electric wires be laid underground.—Dec. 5.

Electricity, New York, Peter Claussen, employed by North New York Lighting Co., killed on wires.—Dec. 9.

Electricity, Toledo, Ohio, Dalton Edward, foreman gang-r of Lake Shore Railway, by wire.—Dec. 18.

Elephant keeper in Barnum's circus gored to death by his charge, London, Eng.—Dec. 3.

Explosion, Asheville, North Carolina, William Gates and Lewis Guthrie killed, and others injured by explosion of gasometer of city.—Dec. 21.

Explosion, Belmese mines, Spain, large number of miners killed and injured by.—Dec. 13.

Explosion, Butler, Pa., nitro-glycerine explosion at Butler Torpedo Company's Magazine, factory demolished, two men killed.—Dec. 10.

Explosion, Colfax, boiler at Calhoun's bursts, killing 8 persons and injuring many others.—Dec. 5.

Explosion, Chicago, explosion of sawdust in Horn Bros' furniture factory fatally injures two young men.—Dec. 5.

Explosion, Dallas, Texas, several persons killed, others injured, by bursting of mold at the Mather Machine Company's works.—Dec. 28.

Explosion, Edmore, Michigan, boiler in Nelf Bros' mill bursts, killing one and injuring three others.—Dec. 25.

Explosion, Marion, Md., boiler at Governor Jackson's mill bursts, William Ferris killed, many others seriously injured.—Dec. 5.

Explosion, Newark, N. J., ammonia pipes connected with patent ice machine in brewery of Chas. Trety explodes, causing damage \$100,000.—Dec. 3.

Explosion, New Philadelphia, Ohio, cylinder bursts in rolling mill at, killing one and injuring another.—Dec. 20.

Explosions, North Clarendon near Warren, Pa., three glycerine magazines owned by the Rock Glycerine Co., John Kuehn and Mr. McKay, blow up, loss \$100,000.—Dec. 15.

Fall of bridge, Williamsport, one man killed and others injured by.—Dec. 27.

Fall of tree, Frazer River Road, Vancouver, B. C., four young men killed by, whilst sleighing.—Dec. 26.

Fall from window, Zanzibar, Emin Pasha critically injured at.—Dec. 5.

## ACCIDENTS.—Continued.

Fall in making high air jump, New Orleans, La., Baptiste Pey and professional, illca.—Dec. 2.

Fall, Waterville, Me., weight from town clock in Unitarian church falls on organ, etc., damage \$10,000.—Dec. 2.

Falling of building, Swerlowes, Hungary, sugar factory collapses at 8 killed, many others injured.—Dec. 5.

Fire, Amsterdam, Hou 1 Saïsse burned down.—Dec. 9.

Fire, Bridgewater, Virginia, Drikwater College destroyed by.—Dec. 30.

Fire, Brooklyn, Flats Nos 61 and 65 Columbia Heights damaged to extent of \$25,000.—Dec. 30.

Fire, Brooklyn, Oil 11th factory of William Burser & Co. destroyed, loss \$50,000.—Dec. 27.

Fire, Buffalo, N. Y., Exchange elevator destroyed by, damage \$225,000.—Dec. 15.

Fire, Detroit, Telden School burned, several scholars fatally injured.—Dec. 19.

Fire, Detroit, Michigan, the Finney House damaged by, one guest killed.—Dec. 9.

Fire, Detroit, Mich., wine stores of Eugene Lebeuf destroyed, loss \$25,000.—Dec. 2.

Fire, Detroit, Mich., residence of ex mayor Thompson destroyed by loss \$75,000.—Dec. 1.

Fire, East Tawa, Mich., Miner House Hotel, damaged by; two men names unknown, burned to death.—Dec. 5.

Fire, Forth Worth, Texas, Cotton Congress at, destroyed, loss \$150,000.—Dec. 23.

Fire, Freelon, Ont., Roman Catholic church in, damaged by, loss \$8,000.—Dec. 17.

Fire, Gratz, Prussia, Silesia, chandelier falling in ball room ignites dresses of two ladies who are burned to death.—Dec. 7.

Fire, Humboldt, Kansas, flour mills of Lindsey & Robinson destroyed at. Loss \$100,000.—Dec. 7.

Fire, Hopkinton, New Hampshire, barn of Messrs. E. Dodge burned, two men killed, loss \$25,000.—Dec. 16.

Fire, Haron-town, Thavore Cross, his wife, eight children and a visitor burned to death in fire of their residence.—Dec. 29.

Fire, Havana, Cuba, four thousand barrels of coal oil burned.—Dec. 21.

Fire, Indianapolis, Indiana, the Indiana Wheel Works destroyed by fire, loss \$100,000.—Dec. 13.

Fire, Inverness, Que., Court House destroyed by.—Dec. 9.

Fire, Ivorydale near Cincinnati, Thomas Emery & Sons' Candle Works, loss \$100,000.—Dec. 23.

Fire, Johnstown, Pa., Main street Opera House in, groundless panic in, ten killed and over eighty seriously injured.—Dec. 11.

Fire, Joliet, Illinois, Joliet Manufacturing Company burned out. Damage \$35,000.—Dec. 10.

Fire, Kansas City, Mo., Western Sash and Door Company's premises and stock damaged by fire, damages \$80,000.—Dec. 3.

Fire, Kingston, Ont., John Madden and wife burned to death in fire of their dwelling.—Dec. 5.

Fire, Knolminster, Missouri, Western Brick Works at, destroyed, estimated damage \$75,000.—Dec. 1.

Fire, Lancaster, Penn., Spike works of Downey Bros., and umbrella-handle factory of Samuel Downey, destroyed by, loss \$40,000.—Dec. 30.

Fire, Lansdowne, Mrs. John Maddler and child burned to death at, in fire of their residence.—Dec. 4.

Fire, Leesburg near Wabash, Ind., small town of, partially destroyed by, loss \$20,000.—Dec. 22.

Fire, Lewistown, Pa., several shops and dwellings occupied by J. Leopold and McCurdy and others destroyed, damage \$20,000.—Dec. 23.

Fire, Lock Port, N. Y., flour mill of Saxon & Thompson of Troy, destroyed by. Loss \$250,000.—Dec. 8.

Fire, London, Eng., Salvation Army, headquarters of, in, destroyed by.—Dec. 2.

Fire, Machus, New York, dry goods store of Rowland & Austin, loss heavy.—Dec. 2.

## ACCIDENTS.—Continued.

Fire, Macon, Mo., six buildings occupied by J. M. Valentine and others destroyed, damage \$15,000.—Dec. 29.

Fire, Meredith Village near Laconia, New Hampshire, Hodgeson's Hosiery Mill and other buildings destroyed, loss \$100,000.—Dec. 28.

Fire, Minneapolis, office of *Tribune* and other newspapers destroyed twenty-five persons burned to death.—Dec. 1.

Fire, Minneapolis, Coroner's jury, on inquest on deaths caused by fire of *Tribune* office, censure proprietors of building.—Dec. 5.

Fire, Minneapolis, Pillsbury Science Hall partially destroyed by, damage \$10,000.—Dec. 4.

Fire, New York, Everett building damaged by, to extent of \$25,000.—Dec. 27.

Fire, Newburgh, New York, Hudson River Woolen mills damaged by. Loss \$50,000.—Dec. 6.

Fire, New York, National Line Steamship Company's Dock, five killed, others fatally or seriously injured.—Dec. 7.

Fire, New York, five story building No. 36 East Fourteenth street, gutted. Damage \$265,000.—Dec. 8.

Fire, New York, Jacob Bros. piano manufactory, damage \$25,000.—Dec. 17.

Fire, New York Presbyterian Hospital injured by.—Dec. 20.

Fire, New Westminster, B.C., wooden building occupied by the Columbian Printing Co., Loyal & Co., stationers, Wolfenden Bros., grocers, and others, destroyed, loss \$64,000.—Dec. 22.

Fire, North Troy, Vermont, Eastman Machine Company's and adjacent buildings destroyed, damage \$23,000.—Dec. 22.

Fire, Omaha, three children perish in destruction of Mrs. L. Schip's house.—Dec. 26.

Fire, Petrolia, Ont., Main, Argyle and Fairview streets destroyed by. Loss between \$85,000 and \$100,000.—Dec. 27.

Fire, Philadelphia, oil and varnish department of Thomas Potter, Sons & Co., oil cloth manufactory, damaged to extent of \$8,000.—Dec. 27.

Fire, Philadelphia, Sixth Independent Christian Church destroyed by, loss \$4,000.—Dec. 21.

Fire, Philadelphia, Pa., bakery of Gustave Gross consumed by, Mrs. Gushave and four children burned to death.—Dec. 2.

Fire, Philadelphia, three story building on Second and Huntingdon Streets burned down, nine people burned to death.—Dec. 2.

Fire, Pittsburg, Pa., the Monongahela House destroyed, loss \$100,000.—Dec. 5.

Fire, Pullman, Chicago, old town of Pullman, now part of Chicago, nearly consumed.—Dec. 4.

Fire, Quincy, Illinois, Miller Boger Cracker and Candy Company's factory destroyed. Damage \$50,000. Dec. 11.

Fire, Rock River near Cleveland, Ohio, barn of D. P. Rella burned, loss \$28,000.—Dec. 24.

Fire, San Francisco, St. Ignatius Church and adjoining business stores burned, loss \$10,000.—Dec. 27.

Fire, St. Louis, six story building, Nos. 319 and 321 North Third St. destroyed by, total loss \$100,000.—Dec. 20.

Fire, St. Louis, large freight house destroyed by, loss unknown.—Dec. 21.

Fire, Seymour, Connecticut, S. Y. Beach's business block destroyed by, loss very great but not ascertained.—Dec. 23.

Fire, Swaledale, Iowa, business part of town destroyed by.—Dec. 20.

Fire, Sydney, New South Wales, the wharves of the New Zealand Steamship Company with stores destroyed.—Dec. 25.

Fire, Toledo, Iowa, Western College burned down, loss \$150,000.—Dec. 26.

Fire, Trinidad, Colorado, United States, livery stable, loss \$30,000.—Dec. 17.

Fire, Yicksburg, Mississippi, Switzer, Newartler & Co.'s, Bea & Jackson's, Lewis Bros.' stores destroyed by, loss \$160,000.—Dec. 24.

Fire, Villa Lerdo, Mexico, Theatre burned, two lives lost.—Dec. 27.

Fire, Vincennes, Indiana, Bell-Armistead Sewer Pipe Works, loss \$27,000.—Dec. 17.

Fire, Virginia, Christ Episcopal Church partially wrecked by.—Dec. 22.

Fire, Watertown, Wis., Tremont House burns and J. D. Macy's wagon works, loss \$75,000.—Dec. 1.

Fire, Westport Harbor, Mass., residence of Commodore Grinnell of the U.S. navy destroyed by.—Dec. 10.

Fire, Yazoo City, Mississippi, Citizens warehouse, 6,000 bales of cotton and seven freight cars burned, loss \$327,000.—Dec. 28.

Flood, Johnston, Pa., Woodvale and Lincoln St. bridges over river Conemaugh swept away.—Dec. 15.

Floods, Sacramento River, flooding of, causes great damage in California.—Dec. 13.

## ACCIDENTS.—Continued.

Floods, Sutter County, California, Johnson levee bursts, flooding thousands of acres.—Dec. 15.

Floods, Falls river floods bye-lying lands, damage estimated at \$250,000.—Dec. 15.

Mining, Angel's Camp, Calaveras, Uteca, mine caves in, entombing seventeen miners.—Dec. 22.

Mining, Calumet, Michigan, three miners and a drill boy killed by premature blast in Osceola mine.—Dec. 16.

Mining, Crystal Falls, Michigan, Calumet mine flooded.—Dec. 9.

Railway, Andover, Mass., twenty persons injured by projecting timber from freight car passing passenger train.—Dec. 22.

Railway, Crawfordsville, Indiana, freight train on Vandalla road in collision, one killed, others injured.—Dec. 16.

Railway, Dane Park, Chicago Express on Lake Shore and Michigan Southern railroad wrecked by night switch, Geo. Wilson, fireman, killed, others injured.—Dec. 6.

Railway, Fort Gay, Greenbrier County, thirteen freight cars break, down on Chesapeake & Ohio Road, Birman Leighton killed, engineer seriously injured.—Dec. 29.

Railways, Greensburg, Pa., express train on Pennsylvania Railroad wrecked at, several injured.—Dec. 4.

Railway, Lary's, Penna., Coroner's jury on body of engineer Musick, killed in accident on 21st inst., return verdict of manslaughter against engineer and conductor of colliding freight train.—Dec. 30.

Railway, Little Ferry, N. J., train runs into open, three men drowned.—Dec. 14.

Railway, Washington, D. C., wagon struck by passing train, three killed, 11 injured badly, gate keeper arrested for manslaughter.—Dec. 14.

Railway, White Sulphur Springs, West Virginia, accident on Chesapeake & Ohio Railway, ten persons killed, fifteen injured.—Dec. 2.

Railway, Wilkes-Barre, Pa., Miss Annie Campbell and Benjamin Lovett killed on railway crossing.—Dec. 25.

Railway, Wilks-shire, Penna., three men out of a party of Philadelphia run over and killed on railway track.—Dec. 16.

AFRICA.—Emin Pascha, Zanzibar, seriously injured by fall from window.—Dec. 5.

Pevrier C. pain, African explorer, arrival of, at Mozambique, reported.—Dec. 6.

Major Serra Pinto recalled by Portuguese Government in conflict with British demand.—Dec. 27.

Mozambique, Capt. Pevrier, African explorer, arrives at, reported.—Dec. 6.

Peters Dr., despatches received in London, Eng., from Lieutenant Tiedeman from Adlo in Bernet Royal, dated Nov. 28, containing assurances of safety of expedition.—Dec. 30.

Solah, two French missionaries and their escort of eight Greeks murdered.—Reported Dec. 30.

Stanley's mission, letters from Lieutenant W. G. Stairs received in Halifax.—Dec. 5.

Zanzibar, Stanley H. M., arrives at.—Dec. 6.

Zanzibar, Dr. Peters and Lieutenant Liedlman, explorers, stated to be dead.—Dec. 2.

Zanzibar, Bushiri's force routed by Lieutenant Selmidt with some loss of life.—Dec. 8.

Zanzibar, Sultry, of decorated with Grand Cross of St. Michael and St. George.—Dec. 16.

King Swengwa subdues rebellion against his authority.—Dec. 18.

Swazeland, of two English and one French colonial governors accepted by natives of.—Dec. 12.

Alaska, fisheries, of renewal of lease to Alaska Commercial Co. refused by U.S. Under Secretary of Treasury.—Dec. 18.

AMERICA, Pan-American Conference, Washington, debate on report of committee on rules.—Dec. 2.

Pan-American Congress visits New York as guests of the city.—Dec. 16.

American Geological Society, New York, election of officers at.—Dec. 20.

American Society of Naturalists, New York, election of officers at.—Dec. 28.

Ashland Company, nearly whole of, bought up by an English syndicate, reported.—Dec. 1.

Astronomical, Geneva, N.Y., new comet discovered by Professor Brooks et.—Dec. 25.

AUSTRIA.—Vienna, dynamite conspiracy to assassinate Hungarian Prime Minister Tisza, discovered by police.—Dec. 2.

Hungary, Vienna, Lower House of Hungarian Diet, Prime Minister Tisza, in *Budget* debate, repudiates intention to resign.—Dec. 2.

Hungary, diet, on second ballot all the German candidates for elected.—Dec. 30.

## AUSTRIA.—Continued.

- Vienna Reichsrath. Budget introduced in.—Dec. 3.  
Vienna, Archduke Charles Louis appointed putative Regent.—Dec. 10.
- Baltimore, five commissioners appointed by mayor to examine the various city departments, with a view to reduction of expenditure.—Dec. 1.
- Baum Green B., appointment as commissioner of pensions confirmed by U. S. Senate.—Dec.
- Black G. P., U. S. attorney for Eastern Michigan, resigns.—Dec. 21.
- Biggs John F., acquitted on charge of murder of Dr. Cronin of Chicago.—Dec. 16.
- Belgium, Brussels, anti-slavery congress at, recommends adoption of local military stations with exceptional powers in all African territory for suppression of slave traffic.—Dec. 2.
- Belgium, Brussels, Minister of Justice denounced in Chamber of Deputies.—Dec. 5.
- Bell Telephone Company, dividend of \$3 per share to stockholders of record of December 31st declared.—Dec. 13.
- Blair Hon. Andrew G., premier of New Brunswick, on French in public speech.—Dec. 13.
- Boulton Major Chas. A., of Shell River, Manitoba, appointed to Senate, vice Hon. Dr. Schultz appointed Lieut.-Gov. of Manitoba.—Dec. 10.
- Bourcier Mr. (clerk of House of Commons), in lecture at Toronto, compares the political constitutions of Canada and the United States.—Dec. 3.
- Bourke Martin with Patrick O'Sullivan and Daniel Conaghan found guilty of murder of Dr. Cronin of Chicago, and sentenced to imprisonment for life.—Dec. 16.
- BRAZIL.—French warship dispatched to.—Dec. 4.
- Mr. Spuller, Minister of Foreign Affairs, states in Chamber of Deputies, Paris, that the Provisional Government will be recognized of France when it has placed itself in diplomatic relations with French authorities.—Dec. 2.
- Baron de Penedo, Brazilian Minister to England, dismissed from diplomatic service of expressions hostile to Brazilian Republic.—Dec. 5.
- Paris, Municipal Council congratulates the new Republic.—Dec. 6.  
The Portuguese minister recognizes the Provisional Government.—Dec. 6.
- Don Pedro's account of his dethronement.—Dec. 8.  
Count of Eu gives his version of cause of revolution. See newspapers.—Dec. 9.
- Motion of Mr. Morgan in U. S. Senate for recognition of United States of Brazil falls through for want of quorum.—Dec. 20.
- Decree dated, issued, banishing ex-Emperor Dom Pedro together with other members of Royal family. Senator Martino confiscates Crown treasury and withholds money grant.—Dec. 21.
- Rio Janeiro, Martial Law decreed.—Dec. 26.  
Reported confiscation of ex-Emperor's estates and personal property denied.—Dec. 23.
- Brewer D. J., of Kansas, appointed associate Judge of Supreme Court by United States.—Dec. 4.
- Brown Ex. Treasurer, resignation of, accepted by Manitoba Government.—Dec. 2.
- Bulgaria, Provisional Commercial agreement with, to commence July 1, and continue for two years, signed by Great Britain.—Dec. 30.
- Canadian, Ottawa, Police North-West Mounted, control of, transferred to Minister of Railways, by Order in Council.—Dec. 9.
- Canada, Parliament of, Senate, Major Charles A. Boulton, of Shell River, Manitoba, appointed Lieut. Gov., vice Hon. Dr. Schultz appointed Lieut.-Governor of Manitoba.—Dec. 10.
- Canada, Parliament of, Senate, J. A. Louzhead, Q. C., of Calgary, appointed to, vice Hon. Senator Hardesty deceased.—Dec. 10.
- Canada, mission between United States and, advocated before Senate Committee of U. S. by Erastus Winman and others.—Dec. 30.
- Cause, N. S., telegraphic communication between, and Montreal completed by C. P. R. Co.—Dec. 17.
- Cheney A. C., his appointment as delegate to International Marine Conference, see S. S. International Marine Conference.
- CHINA.—The Chinese Minister protests to Washington against restrictions upon Chinese immigration to United States.—Dec. 1.  
Nanking, inland and Methodist Episcopal mission at, destroyed by mobs, reported.—Dec. 7.
- Citizens' League, Montreal, meeting of.—Dec. 12.
- Coal, Marion County, Tennessee, Coal & Mineral Land to value of \$2,212,000 purchased by English syndicate.—Dec. 9.
- Cockeard Col. John, re-elected President of New York Press Club.—Dec. 2.
- Colby Hon. Mr., seeks re-election at Stansfeld consequent on his admission to Cabinet.—Dec. 5.

- Colby Hon. C. C., re-elected for Stansfeld.—Dec. 18.
- Columbus Christodher, Pope petitioned by eight hundred priests and laymen to canonize.—Dec. 1.
- "Combines," Akron, Pottery, the Akron & Canton Stoneware Agency to include eight hundred pottery manufactures established.—Dec. 1.
- Combines, Coal, Marion County, Tennessee, coal and mineral land purchased at, by English syndicate for \$2,212,000.—Dec. 9.
- Combines, copper syndicate formed in London.—Dec. 5.
- Combines, Glass, Syracuse, United and Franklin glass companies and the Clyde Glass Company consolidated under name of the United Glass Company.—Dec. 13.
- Combines, London, Eng., syndicate formed with capital of \$10,000,000 to buy out British carpet manufacturers.—Dec. 21.
- Combines, wheels, Wapakoneta, O., Wheel Trust with capital stock of \$2,000,000 registered.—Dec.
- Combines, Weyand and Young Brewery, Cincinnati, and the Crescent Brewery, Aurora, Indiana, bought, and options on five breweries in Toledo, Ohio, obtained by English syndicate, for \$3,225,000.—Dec. 21.
- "Combines" (See also Trusts).
- Commercial Travellers' Association of Canada, Toronto, quarterly meeting and election of officers at.—Dec. 7.
- Commercial Travellers' Association of Canada, Toronto, seventeenth annual meeting of.—Dec. 27.
- Copyright, Boston, International Copyright Association, bill now before Congress approved at annual meeting of, at.—Dec. 30.
- Corbin W. E., vice-president and manager of U. S. Commercial and Trading Co., arrested for fraudulent issue of notes.—Dec. 17.
- Corea, attempted assassination of.—Dec. 18.
- Cotton, Dominion Grey Cotton Association, Montreal, meeting of.—Dec. 12.
- Conaghan Daniel with Patrick O'Sullivan and Martin Bourke, found guilty of murder of Dr. Cronin of Chicago, and sentenced to penal servitude for life.—Dec. 16.
- CRETE.—Insurgents who have given up their arms amnestied by Sultan.—Dec. 9.
- CRIMES.—Burglary, Cleveland, James Wells sentenced to ten years in penitentiary.—Dec. 1.
- Absconding, South Dakota, Turner G. Dexter, falsely representing himself as agent for the Citizens' Life Association of Cherokee, Ia., absconds with many thousand dollars of premiums.—Dec. 20.
- Arson, Vesper, Wisconsin, lumber yard of Henry Sherry & Co. destroyed, loss \$25,000.—Dec. 20.
- Banking, false returns, Cincinnati, O., Means Wm., president, and DeCamp John P., vice-president of the Metropolitan Bank, charged with swearing to false statements of the bank's condition in 1887 acquitted.—Dec. 20.
- Bigamy, Baltimore, Bernhard alias Dagwalt David A., arrested for.—Dec. 18.
- Bookers, Chicago, Mack M. B., ex-secretary of Areamum Building Loan and Homestead Association, reported missing with \$7,500.—Dec. 18.
- Burglary, Bowie, Texas, safe of County Treasurer's office robbed of \$5,000.—Dec. 13.
- Burglary, Kosciusko, Mississippi, safe of W. Carter and J. D. Lee, rifled by, between \$20,000 and \$25,000 taken.—Dec. 10.
- Burglary, Media, Pa., Frederick F. Hopkins sentenced to five years hard labor.—Dec. 2.
- Burglary, Sluickenny, Pa., hardware store of A. W. Campbell rifled.—Dec. 4.
- Bookers, Philadelphia, Pa., Ditman, I., president of Quebec City Bank, having been missing several days, removed from directorate.—Dec. 13.
- Conspiracy, Cincinnati, Wm. Means and J. R. D. Camp of the late Metropolitan Bank, trial of, for conspiracy to violate United States Banking Law, opened in Supreme Court.—Dec. 5.
- Conspiracy to defraud, Pittsburg, Porter Alderman W. H., convicted of receiving money to settle illegal liquor selling cases.—Dec. 31.
- Conspiracy to rob, Denver, Colorado, ex Lieut. of Police James Comar and James Marshall of Kansas City, sentenced to imprisonment of two years and fine of \$1,000 each for conspiracy to rob Rio Grande train in April.—Dec. 2.
- Defalcation, Bloomington, Ills., W. H. Furman, broker and money lender, defalcations of, ascertained at \$143,000.—Dec. 6.
- Embezzlement, Binghamton, N. Y., Hemmingway E. B., druggist and private banker, absconds, leaving deficiencies of over \$15,000.—Dec. 4.
- Embezzlement, Mount Vernon, Indiana, Lord F. M., superintendent of Waterworks at, arrested on charge of embezzling \$1,700.—Dec. 26.
- Embezzlement, Washington, Edward Silcott, cashier of, sergeant at arms in House of Representatives, absconds with \$93,000.—Dec. 1.



## CRIMES.—Continued.

Extortion, New York, three gaugers of the Second Internal Revenue District, viz., John R. Byrne, Peter G. Brumberg and John Dozier, indicted for false gauging and extortion.—Dec. 11.

False pretences, Ottawa, Robert Jackson and Geo. Anderson sentenced for obtaining large sums by.—Dec. 6.

Forgery, Buffalo, Wm. Fornoff arrested for forging pay orders on the City Treasurer.—Dec. 6.

Forgery, Cincinnati, R. G. Wood charged at with forging names of Gov. elect Campbell, Senator Sherman and others, with forged of ballot box contract.—Dec. 3.

Forgery, Elmira, N.Y., White Ella O., arrested for, to extent of \$25,000.—Nov. 5.

Forgery, New York, Chui Fong, forger and defaulter, absconds.—Dec. 22.

Forgery, New York, Corbin H. E., vice-president and manager of the U.S. Commercial and Trading Co., arrested for fraudulent issue of notes.—Dec. 17.

Forgery, Toledo, Ohio, Chas. Selner, proprietor of Sunday  *Herald*  and  *Times* , arrested for.—Dec. 18.

Fraud, Salt Lake City, Mayor Armstrong and several officers arrested for.—Dec. 18.

Fraudulent trading, Greenville, Upper Carolina, Nex J. T., extensive merchant, arrested for.—Dec. 24.

Grand larceny and forgery, Washington, Sidcott G. E., indicted by grand jury for.—Dec. 20.

Lynching, Barrowell, eight negroes accused of murder lynched.—Dec. 28.

Manslaughter, New York, Pierce Chas. W., superintendent of lamps of the Brush Electric Light Company in New York, indicted for manslaughter of Henry Harris of an electric shock from a lamp on Nov. 7th last.—Dec. 27.

Manslaughter, Pomeroy, Ohio, Radcliff James H., found guilty of murder of Louis H. Cotterill.—Dec. 26.

Outrage, Toronto, McKew James, arrested for, an infant daughter of Henry Chisholm.—Dec. 5.

Perjury, Atlanta, Georgia, McDon Glen, a witness on trial of Geo. Edleman for murder, sentenced to 8 years imprisonment for.—Dec. 19.

Prison breaking, Kingston, Ont, five convicts escape from penitentiary.—Dec. 25.

Robbery, Rang's Station, Texas, train on Anglo Branch of Santa Fe, line held up.—Dec. 20.

Robbery, Berwyn, Ardore, I. T., the Santa Fe Express messenger boarded by train robbers who collect \$30,000. Nov. 26, reported in *The N.Y. World*.—Dec. 4.

Smuggling, Halifax, Elslor John, of Crow Harbor, fined \$600, with six months imprisonment, and Macdonald Thomas, of Guysboro, Nova Scotia, sentenced to three months imprisonment, for smuggling American whiskey from Isle of St. Pierre.—Dec. 24.

Smuggling, Tacoma, W. T., Bill Euston and a confederate, opium smugglers, captured.—Dec. 11.

Theft, O'ryenne, Wyo., Adams T. B., robs his employer of \$15,000.—Dec. 19.

Subornation of jurors, Chicago, true bill returned by Grand Jury against J. E. Graham, A. L. Hinks, F. W. Smith, M. Solomon, J. O'Donnell, T. Kavanagh and Joseph Komen for conspiracy to bribe the jury in Cronan case.—Dec. 24.

Theft, Buffalo, N.Y., Bapst E. F., general delivery clerk in Post Office at, being arrested for, pleads guilty to theft of letters.—Dec. 26.

Theft, San Angelo, five men enter express office and take \$7,000 from safes.—Dec. 15.

Theft, Urbana, Ohio, Hickney Isaac (conductor) and Berry, Ramsay and Clark (brakemen) on N.Y., Penn. & Ohio Railway, arrested for robbery of freight cars on.—Dec. 5.

Theft, Denver, Colorado, Woodward Joseph, mailing clerk, arrested for stealing letters amounting to \$1,200.—Dec. 25.

Theft, Nevison W. W., confesses to theft of package of \$7,500 missing from office of United States Express Co. since 1884.—Dec. 3.

Trains, wrecking, Wabash, Indiana, William Marquis, aged 17, confesses to attempting to wreck train.—Dec. 17.

Cuba Island, of resolution authorizing president of United States to negotiate with Governor of Spain for establishment of republic on, introduced into Senate by Mr. Call.—Dec. 11.

Davis Hon. Jefferson, dies at New Orleans.—D. e. 6.

Davis Jefferson, New Orleans, funeral of.—D. e. 11.

DEATHS, Brever rev. S.B., presiding Elder of Louisville conference of the Methodist Church, South.—Dec. 4.

Ashburner Charles A., the geologist, at Pittsburg.—Dec. 24.

Atwood General David, ex-Congressman, and editor of the *State Journal*, at Madison, Wisconsin.—Dec. 11.

Barlow Thomas Oldham, R. A., celebrated English engraver.—Dec. 27.

## DEATHS.—Continued.

Brazil, Donna Theresa Christine Marie, ex-Empress of, at Deporto.—Dec. 28.

Bronson H. F., of the Bronson-Weston Lumber Company, at Ottawa.—Dec. 7.

Browning Robert, poet, at Venice.—Dec. 12.

Beie Cutbirt, Edward Bradley, known as.—Dec. 13.

Bradley Edward, known as Cutbirt Beie.—Dec. 13.

Boneau Francis, aged 105 years, 9 months, at New Bedford, Mass.—Dec. 12.

Burnham George, engineer of Stoningham line boat train, in attempting to avert disaster.—Dec. 2.

Caldwell Wm. Aspinall, celebrated baseball player, at Baltimore.—Dec. 13.

Cannon Mrs. Joseph, wife of U. S. Representative Cannon of Illinois, at Danville, Ill.—Dec. 16.

Carr Dr. Joseph, discoverer of natural gas, at Findlay, O.—D. e. 22.

Crory Charles, prominent lawyer and politician, New York.—Nov. 30.

Dummschino Dr., leading physician of Paris, of influenza.—Dec. 21.

Davis Hon. Jefferson, at New Orleans.—Dec. 6.

Day Benjamin H., founder of the *New York Sun*.—Dec. 21.

De Lavour J. L., prominent mason and ex-treasurer of Board of Education, in Camden, N.J.—Dec. 24.

Dillon Joseph R. of the Republican State Executive Committee of Finance of Tennessee, at Nashville.—Dec. 10.

Forster Dr. Augustus, manager of the Burg Theatre, Vienna.—Dec. 23.

Forsyth Rev. Walter, well-known Presbyterian minister, in Chicago.—Dec. 30.

Fox Joseph G., A.M., professor of Civil Topographical Engineering at Lafayette College, Easton, Pa.—Dec. 26.

Fraser Donald, ex-M.P.P. of Princeton County, N.S.—Dec. 12.

Freeze H. S., LL.D., professor of classics at University of Michigan in Ann Arbor.—Dec. 7.

Green T. C. senior Judge of Supreme Court of West Virginia.—Dec. 1.

Havemeyer Hector C., president of the Havemeyer Sugar Refining Co. of New York, at Paris.—Dec. 14.

High State superintendent, at Lancaster, Pa.—Dec. 13.

Jeffrey Dr. Reuben, Baptist minister, in New York.—Dec. 14.

Johnson Oliver, anti-slavery advocate, at Brooklyn.—Dec. 10.

Karolyi Count, Aloys Karolyi de Nagy, Karolyi formerly Austrian ambassador to Great Britain and Germany, at Passsburg, Hungary.—Dec. 27.

Kewly Warren B., cashier in United States Treasury Department, in Reading, Pa.—Dec. 20.

Kendrick Rev. J. R., president of Vassar College, at Poughkeepsie, N.Y.—Dec. 11.

Kennedy Harvey, prominent sharebroker on Wall street.—Dec. 9.

Lord Mrs. Scott, sister of Mrs. Harrison, at Washington.—Dec. 10.

Mackay Charles, LL.D., author and journalist, London.—Dec. 24.

McAllen A. K. F., retired Garrison Artillery Captain, Montreal.—Dec. 18.

McFarland Robt. W., attorney, of Owensbury, Kentucky.—Dec. 15.

McDonald J., manager of London *Times*.—Dec. 10.

Mellviene Spencer, of Chester, Pa., director of the Delaware Mutual Safety Insurance Co., at Philadelphia.—Dec. 13.

Mollenhauer Henry, musical composer, at Brooklyn.—Dec. 30.

Morrell Judge Ambrose, in New York.—Dec. 14.

Moses Lieutenant-Col. Isaac, retired broker, Civil War veteran, at New York.—Dec. 15.

Nichols Chas. Henry, of New York, eminent physician and medical superintendent at Bloomingdale Insane Asylum.—Dec. 16.

O'Hara, "oldest man in Ill' mos", at age of 110, at Chicago.—Dec. 24.

Olsen Edward, Ph.D., ex-Professor of Greek in Chicago University, in fire of *Prison* office.—Nov. 30.

Perkins Henry, in manager and treasurer of House of Refuge, and prominent citizen of Philadelphia.—Dec. 28.

Peynand Baptiste, the high diver, at New Orleans, La.—Dec. 2.

Plunkett Capt. M. P. for Cook district.—Dec. 6.

Polfrey General T. W., war veteran and historian, at Cannes, France.—Dec. 6.

Pomeroy J. J., rev. Dr. of Central Presbyterian Church, at Chambersburg, Penn.—Dec. 1.

Prime Rev. Frederick, member of All Saints Church, Kingston.—Dec. 10.

Rathbone J. H., Past Supreme Chancellor and founder of Knights of Pythia, at Lima, Ohio.—Dec. 9.

## DEATHS.—Continued.

- Riddle William N., formerly president of the Pean. National Bank of Pittsburg, at New York.—Dec. 9.
- Rogers Major John D., Lexington, Virginia, solicitor of the Chesapeake & Ohio Railroad.—Dec. 2.
- Romandi Charles R. Von, formerly professor of Modern Languages in Rutgers College, and recently of the State Department, Washington, at St. Martin's, West Indies.—Dec. 29.
- Sawin Geo. W., mathematical instructor at Hardwood College, at Boston.—Dec. 29.
- Searle Henry, champion sculler of the world, at Adelaide.—Dec. 9.
- Shelley Sir Percy Florence, son of poet Percy Bysshe Shelley.—Dec. 5.
- Smith Edward Clarence, principal of Rugby Academy, New York, at same city.—Nov. 30.
- Smith Hon. H. L., owner of the Denver Oil Works, at Boston.—Dec. 30.
- Smith R. S., of Connecticut National Guard, at New Haven.—Dec. 4.
- Steele Samuel Andrew, ex-mayor of Youngstown, O.—Dec. 12.
- Stevens Robert J., U. S. Consul, at Victoria, British Columbia.—Dec. 25.
- Townsend John F., president of Union Club, New York.—Dec. 6.
- Twig Bishop, of Alleghany City, Penn., at Altoona, Penn.—Dec. 7.
- Tyler Mrs. Robert, daughter-in-law of late president Tyler, at Montgomery, Ala.—Dec. 28.
- Vonalvens Herr, vice-president of the Bavarian Chamber.—Dec. 26.
- Williamson A. F., chief of Criminal Investigation Department of the Metropolitan Police Force, London, Eng.—Dec. 9.
- Wolford Henry, city treasurer of Louisville, Kentucky, at Kentucky.—Dec. 27.
- Zimmerman Rev. Geo., founder and pastor of the Fulton Avenue Methodist Episcopal church, at Baltimore.—Dec. 7.
- Democratic Club, Young Men's, Canton, anniversary of.—Dec. 5.
- DIPLOMATIC.—Penedo Baron de, Brazilian minister, dismissed from diplomatic service for hostility to Brazilian Republic.—Dec. 5.
- Ditman Jos. J., removed from presidency of Quaker City Bank, Philadelphia, Pa., on suspicion of having absconded with bank assets.—Dec. 13.
- Dominion Evangelical Alliance, Toronto, election of officers at.—Dec. 5.
- Dory Simco, elected president of the New York, Susquehanna and Western Railroad.—Dec. 28.
- Dual Language, Manitoba, English speaking Roman Catholics denounce proposed legislation abolishing teaching of French in public schools.—Dec. 27.
- Duel, Pesth, Count Karolyi and Count Lazaro fight at.—Dec. 8.
- Duel, Panama, Cal., Harry Lucas and Herbert Priestley fight at.—Dec. 3.
- Earthquake, Aci Reale, Sicily, many persons killed through shock of.—Dec. 25.
- Earthquakes, shocks of, in Bosnia, Dalmatia and the Herzegovine.—Dec. 7.
- ECCLESIASTICAL.—Buffalo, N. Y., Presbytery of, decision for revision of Calvin's creed.—Dec. 2.
- Baltimore, Catholic Young Men's Society organized.—Dec. 15.
- Camden West, Jersey Presbytery on session.—Dec. 4.
- Casgrain rev. Abbé, Pres. of French Section of Royal Society of Canada, leaves on European tour.—Dec. 15.
- Christopher Columbus, eight hundred priests and laymen petition the Pope to canonize.—Dec. 1.
- City of Mexico, Archbishop Labastida, Golden Jubilee of, celebrated.—Dec. 8.
- Cleveland, annual meeting of Baptist Union of.—Dec. 8.
- Cleveland, annual meeting of Ohio Sabbath Association.—Dec. 16.
- Cleveland, Baptist ministers conference at.—Dec. 1.
- Cleveland, convention of the Episcopal Church of.—Dec. 2.
- Cleveland, Daniel W. Harrison and Benson S. Barrett excommunicated from Woodland Avenue Presbyterian Church.—Dec. 1.
- Cleveland, Deaconesses address in First Methodist Church by Mrs. S. E. Graves, the first Deaconess appointed for centuries.—Dec. 1.
- Indiana, O., Nineteenth District Sunday School Convention.—Dec. 12.
- Ireland, Drury, Dr. O'Doherty appointed bishop of.—Dec. 24.
- Manchester, Eng., Liberal Federation at, adopts resolutions in favor of dis-establishment of established Church in Wales.—Dec. 3.
- Montreal, Protestant Ministerial Association, fourth annual meeting and election of officers of.—Dec. 1.
- New York, Reformed Episcopal Church, sixteenth anniversary of establishment of, celebrated at.—Dec. 2.
- Philadelphia, fifty-sixth anniversary of Bishop White Prayer Society.—Dec. 22.
- Pittsburg, in the contest as to supremacy of convent of Mt. St. Ursula, the Pope decides in favor of Sister Alphonse.—Dec. 10.

## ECCLESIASTICAL.—Continued.

- Pittsburg, Bishop Twigg of Roman Catholic diocese of, at Altoona, Pa.—Dec. 8.
- Rome, Archbishops of Paris, Lyons and Prague receive cardinals' hats.—Dec. 30.
- St. Paul, Minnesota, Rt. Rev. John Stanley of St. Paul; Rt. Rev. James McGoldrick, of Minneapolis; and Rt. Rev. Joseph B. Cotter of Winona, consecrated Roman Catholic bishops.—Dec. 27.
- Satelli Mgr., reaches Cork.—Dec. 5.
- Satelli, Archbishop of, visits England.—Dec. 9.
- Toronto, Cleary Archbishop of, preconized.—Dec. 30.
- Eclipse of Sun.—Dec. 22.
- EDUCATIONAL.—Mexico, City of, Association of Teachers formed for Mexico.—Dec. 1.
- Holland, La Hague, government bill adopted for grants to denominational schools and abolition of free education, except for paupers.—Dec. 6.
- Washington, proposal in Republican caucus to celebrate discovery of America by foundation of National University in capital.—Dec. 4.
- New Haven, Connecticut, appropriation of \$30,000 for provision of free schools for children.—Dec. 6.
- New York, Hebrew Educational Fair opened.—Dec. 9.
- Night schools, Montreal, city grant in aid of, raised from \$1,500 to \$3,000.—Dec. 13.
- Quebec, Letter from Cardinal Taschereau commending night schools read in churches.—Dec. 15.
- Normal Schools, Montreal, Mr. L. O. David, M.P.P., withdraws from School Committee.—Dec. 4.
- Toronto, Minister of Education approves of the supply of free text books in public schools.—Dec. 9.
- Trenton, N. J., State Teachers convention at.—Dec. 26.
- United States, New York Board of Education adopt report recommending teaching of French and German in public schools in certain grades.—Dec. 11.
- Wilkesbarre, Penna., the Luzerne County Teachers, annual session of.—Dec. 16.
- EGYPT, Cairo, advices from South report ruling by Mahdi.—Dec. 6.
- Egypt, the corvée abolished throughout and land tax substituted.—Dec. 12.
- ELECTIONS.—Brome County, Que., England R. N., Conservative, elected for.—Dec. 2.
- Stanstead, Colby Hon. Mr., issues address to electors of, on his admission to Cabinet.—Dec. 5.
- Stanstead, Que., Colby Hon. C. C., re-elected.—Dec. 18.
- ELECTRICITY.—Moorestown, N. J., illuminated by electric light for first time.—Dec. 5.
- New York, Peter Clausen, employee of North New York Lighting Co., killed on wires.—Dec. 9.
- New York, Coroner's jury on body of Henry Harris of, killed by wires on Nov. 30th, censure British Electric Light Company.—Dec. 11.
- Chas. W. Pierce, superintendent of lamps of the British Electric Light Company in New York, indicted for manslaughter in causing death of Henry Harris by an electric shock from a lamp on Nov. 7th last.—Dec. 27.
- Executions by, Rochester, N. Y., the general term of the Fifth department decide in case of Kemmner that executions by, are legal and constitutional.—Dec. 30.
- In suit of British Electric Light Company vs. Fort Wayne Electric Light Company at Indianapolis, defendant company injoined from infringing double burner patented by Plaintiff company.—Dec. 24.
- New York, the Supreme Court at, in case of U. S. Frush and Mount Morris Electric Light Company vs. Mayor Grant et vir, declares the commissioner of Public Works entitled to cut down dangerous and defective works.—Dec. 13.
- Pittsburg, Westinghouse Electric Company devise new system of lighting.—Dec. 13.
- Electricity, Newark, electric railway on new principle invented by Harry W. Smith laid on wharves at.—Dec. 2.
- England R. N., Conservative, elected for Brome County, P. Q., by majority of 169.—Dec. 2.
- EPIDEMICS.—Bagdad, cholera raging at.—Dec. 10.
- Bagdad, outbreak of cholera at, following lines of Tigris and Euphrates, reported.—Dec. 12.
- Diphtheria, Aberdeen and Sioux Falls, S. D., many deaths reported from.—Dec. 26.
- Dublin, typhoid fever prevalent at.—Dec. 23.
- Edmund and McPherson counties, South Dakota, diphtheria very prevalent in Indian settlements at.—Dec. 25.
- Influenza St. Petersburg, epidemic in Russia subsides on 1st in 11 days of sharp frost.—Dec. 9.

## EPIDEMICS.—Continued.

- Influenza, Paris, influenza spreads to.—Dec. 10.  
 Influenza, Belgium, of Antwerp, the epidemic manifests itself in.—Dec. 13.  
 Influenza spreads to Germany.—Dec. 13.  
 Influenza spreads to the United States.—Dec. 18.  
 Influenza, Alsace, entire German garrison prostrate with.—Dec. 23.  
 Kansas, hog cholera prevalent in.—Dec. 11.  
 Marlboro', Mass., diphtheria very prevalent at.—Dec. 11.  
 Monticello, Ill., Diphtheria widely spreading at.—Dec. 4.  
 Paris, two hundred cases of fever reported from.—Dec. 10.  
 Scarlet fever and diphtheria, Campbell County, S. D., numerous deaths from, reported.—Dec. 20.  
 Stockholm, influenza spreads to.—Dec. 10.  
 St. Petersburg, Influenza epidemic at.—Dec. 5.  
 Springwater, N.Y., low fever resembling typhoid prevails at.—Dec. 4.  
 Equal Rights, North Hatley, Stansted, meeting of Association at, Dr Davidson and others, addresses by.—Dec. 6.  
 Equal Rights Association, Ottawa, address by Dalton McCarthy at.—Dec. 12.  
 Equal Rights, Hon. Andrew G. Blair, premier of New Brunswick, upholds the teaching of French in public schools.—Dec. 13.  
 Equal Rights, Meredith Mr., M.P.P., letter of, to Archbishop Cleary, published.—Dec. 28.  
 Evangelical, Boston, American Evangelical Alliance of the United States, general christian conference under auspices of, commences at.—Dec. 4.  
 Executions, Brooklyn, N.Y., John Greenwell, for murder of Lyman S. Weeks in 1887, hanged.—Dec. 6.  
 Execution, New York, Carlton Harry, hanged at, for murder of Policeman Brennan.—Dec. 5.  
 Extradition, new extradition treaty between Canada and the States, submitted by British government to Canadian government.—Dec. 4.  
**FAILURES.**—Boston, Driscoll & Powers, bankers and stockholders.—Dec. 4.  
 Abilene, Kan., First National Bank, suspension of. Liabilities \$116,000.—Dec. 10.  
 Atlanta, Georgia, Akers Bros., millers and corn dealers. Liabilities \$60,000.—Dec. 14.  
 Auburn, New York, Wolff David, fancy store proprietor. Liabilities \$19,000.—Dec. 10.  
 Charlotte, North Carolina, A. Dixon & Co., clothiers, liabilities \$25,000.—Dec. 24.  
 Chattanooga, Tenn., the Central Elevator Company at, liabilities \$169,298.—Dec. 3.  
 Chicago, Myer C. J. L., Son & Co., mantle dealers. Liabilities \$302,000.—Dec. 14.  
 Chicago Point, Long Island, Fitzgerald Brewing Company's Brewery seized by sheriff for \$34,000.—Dec. 16.  
 Chicago, Preble J. O., & Co., and J. R. Sheffield & Co., Pyner, manufacturers, with liabilities of over \$1,000,000.—Dec. 23.  
 Chicago, The Merrill Van Bokkelen Company, commission merchants, liabilities \$230,000 to \$275,000.—Dec. 18.  
 Chicago, Wabash Manufacturing Co., wholesale stationers, liabilities \$200,000.—Dec. 26.  
 Ellenburg, Washington, Lloyd & Co., manufacturers, assign, liabilities \$150,000.—Dec. 27.  
 Kansas, Bank of Richfield. Liabilities \$21,000.—Dec. 14.  
 Leadville, Col., Agassiz Mining Company assign at, liabilities \$114,000.—Dec. 3.  
 Malone, N.Y., third National Bank of, suspends payment.—Dec. 10.  
 Memphis, Tennessee, Anderson Hat Company. Liabilities \$70,000.—Dec. 7.  
 Montreal, Mullarky & Co., boot and shoe manufacturers. Liabilities \$75,000.—Dec. 11.  
 Nanticoke, Pa., Woomey Bros., furniture dealers, liabilities about \$25,000.—Dec. 30.  
 New York Commercial Telegraph Company, sold under sheriff's writ for \$155,000.—Dec. 24.  
 New York, Fuche & Krans, cigarmakers. Liabilities over \$100,000.—Dec. 9.  
 New York, Whitney J. W. & J. B., & Knapp J. A., dry goods commission merchants. Liabilities about \$500,000.—Dec. 9.  
 New York, Cohen Harris, arge clothier. Liabilities \$75,000.—Dec. 13.  
 N. Y., Consumers Coal Company of, No. 18 Broadway, liabilities \$40,000.—Dec. 1.  
 New York, Sloat, Dammel & Co., blank book manufacturers, assign, liabilities \$35,000.—Dec. 30.

## FAILURES.—Continued.

- New York, Stern & Stern, diamond merchants, 13 Martin Lane. Liabilities about \$100,000.—Dec. 1.  
 New York, B. Hill & Co., furriers, liabilities \$50,000.—Dec. 20.  
 New York, Lewis Bros. & Co., dry goods commission merchants, reassignment made to, on their settling with their creditors.—Dec. 21.  
 Niagara, Ont., McIntyre Hope of the Waverley Hotel, at.—Dec. 5.  
 Paris, election of Mr. Greffulus, Boulanger, declared void by Chamber of Deputies.—Dec. 23.  
 Pawnee City, Nebraska, The Nebraska State Bank, liabilities \$50,000.—Dec. 21.  
 Petersburg, Va., Geo. H. Davis & Co., dry goods merchants. Liabilities \$61,000.—Dec. 10.  
 Petersburg, Va., Bailey J. B., dry goods merchant. Liabilities \$11,000.—Dec. 10.  
 Philadelphia, Cox, Lewis & Co., retail dry goods merchants. Liabilities nearly \$200,000.—Dec. 2.  
 Philadelphia, Mellor & Rittenhouse Company, manufacturers of drugs and chemicals. Liabilities \$300,000.—Dec. 2.  
 Toronto, Hamilton H. E. & Co., boot and shoe merchants. Liabilities estimated at \$25,000.—Dec. 4.  
 Toronto, Macfarlane & Son, Contractors. Liabilities estimated at over \$180,000.—Dec. 2.  
 Toronto, Thomson Wm., & Co., Hardware firm. Liabilities estimated at \$75,000.—Dec. 4.  
 Whitney's Point, New York, Hemingway E. B., banker and general dealer. Liabilities about \$40,000.—Dec. 9.  
 Famine, minor county, Dakota, over 300 families perishing from destitution.—Dec. 9.  
 Famine, Russia, Volga, Province of, failure of crops threaten famine.—Dec. 13.  
 Federation of Labor, Boston, Vicomte de Menus, Minister of Agriculture and Commerce of France, addresses.—Dec. 11.  
 Federation of Labor, Boston, adopts resolution against employment of children under 14 years of age.—Dec. 13.  
 Federation of Labor, Boston, adjournment of session of.—Dec. 14.  
**FRANCE.**—Chamber of Deputies, M. Spuller, minister of Foreign affairs, states that the new Brazilian Provisional Government will be recognized by France, where it has placed itself in diplomatic relations with the French authorities.—Dec. 2.  
 Clemenceau urges union of all parties for maintenance of Republic.—Dec. 6.  
 Montabau, Boulanger and Revert, election for invalidated by Chamber of Deputies.—Dec. 5.  
 Jubozot M., Paris, election of, as Boulangist representative sustained by Chamber of Deputies.—Dec. 3.  
 Paris, election of M. Joffin declared invalid by the Bureau of the Chamber of Deputies.—Dec. 4.  
 Paris, elections of Dr. Mery, Boulangist, and of M. Naquet declared void by Chamber of Deputies.—Dec. 17.  
 Paris, election of Mr. Laur, Boulangist, declared void.—Dec. 18.  
 Paris, Bill of amnesty for Boulanger and his supporters rejected by Chamber.—Dec. 18.  
 Senate, bill introduced by M. Marcel Barthe for subjection to the Correctional Tribunal, members of the press libelling ministers and others.—Dec. 3.  
 Farmers' Alliance, St. Louis, the Farmers' Alliance and the Farmers' and Laborers' Union agree to confederate.—Dec. 5.  
 Fisheries, United States, bill protecting fishing by foreign vessels within three leagues of coast line of United States introduced into Senate.—Dec. 4.  
 Fry Cyrus J., appointed Marshal for South Dakota.—Dec. 19.  
 Galena, Lake Memphremagog, rich vein discovered on shore of.—Dec. 13.  
 Gas, Redfield, Spink County, S. D., natural gas discovered at, in great volume.—Dec. 28.  
 Gas, St. Louis, St. Louis Gaslight Company concern acquired by Laclede Gaslight Company for \$4,000,000.—Dec. 24.  
 George Henry, Philadelphia, address to Baptist Ministerial Conference on "The Religious Aspects of the Single Tax."—Dec. 23.  
 Gladstone W. E., at Manchester, Eng.—Dec. 2.  
 Goschen Charles G., son of Chancellor of Imperial Exchange in Montreal on return from trip with Vice-Royal party.—Dec. 1.  
**GERMANY.**—Berlin, cable messages received in, express belief that Dr. Peters and Lieut. Liehnmann are dead.—Dec. 2.  
 Alsace, three hundred and forty-eight Alsatians imprisoned for attempting to evade military duty by emigration.—Dec. 10.  
 Berlin, two hundred miners in Treasury coal mines in, demand petition Emperor to raise wages beyond starvation price.—Dec. 4.  
 Berlin, Socialists Committee on Socialist bill reject clause on expulsion declared essential by Government.—Dec. 4.

## GERMANY.—Continued.

- Berlin, Reichstag, bill introduced by H. Barthé, Progressist, for amelioration of the labor laws opposed by Government.—Dec. 4.
- Dortmund, miners' lockout ended by concession of miners' claims.—Dec. 13.
- Eberfeld, Socialists, trial of Hoettinghoff discloses existence of Socialist clubs.—Dec. 10.
- Eberfeld, forty-four out of ninety-one accused socialists found guilty of belonging to secret societies, and of conspiring to disturb public peace, and sentenced to various terms of imprisonment, the rest acquitted.—Dec. 30.
- Frankfurt, Kaiser William, visits.—Dec. 6.
- Riechstag, Government deprived of power to expel clergymen officially deprived of clerical charge.—Dec. 13.
- Staudan, influenza epidemic exceptionally severe at.—Dec. 10.
- Graham, M.P.P. for East Lambton, sued for alienating affections of wife of one of his constituents.—Dec. 6.
- Grain Receivers' Association, Minneapolis, inauguration of, at.—Dec. 29.
- Hannan Edward, of Troy, appointed by Governor Hill commissioner of Works.—Dec. 17.
- Harly Hon. Mr., Minister of Crown Lands, Toronto, reports diminution in losses by fire in Ontario.—Dec. 6.
- Hayti, rumored disaffection with Hippolyte's government officially denied.—Dec. 7.
- Head Chas. M., resigns presidency of New York, Susquehanna & Western Railroads.—Dec. 28.
- Hebrew Labor Union of the United States formed in New York.—Dec. 25.
- Hematite, Matthead, N.S., valuable seam of red discovered near.—Dec. 5.
- Historical Association, American, Washington, sixth annual meeting of.—Dec. 28-31.
- Holland, Amsterdam, Hotel Suisse destroyed by fire.—Dec. 9.
- Holland, La Hague, Chamber abolishes free State education except for paupers, and substitutes grants in aid to denominational schools.—Dec. 6.
- Hovey Governor's, address on soldiers' rights to pensions in Cleveland *Leader*.—Dec. 3.
- Hudson Bay Co., Bloomington, Ills., defalcations of their agent Fursman ascertained to be \$143,000.—Dec. 6.
- Idaho, bill to admit, as a State, introduced into Senate by Mr. Platt.—Dec. 9.
- India, Bombay, Native Congress formulates demand for popular electoral representation.—Dec. 27.
- Indian Right Association, Philadelphia, seventh annual meeting of.—Dec. 17.
- International Marine Conference, Cheney A. O., President Nicaragua Canal Construction Company, appointed delegate from Nicaragua.—Reported Dec. 2.
- IRELAND, Publisher of the *Munster* sentenced to two months' imprisonment for reported meeting where boycotting advocated.—Dec. 4.
- Armagh, letter from the Premate to Convention, approving Tenants' League.—Dec. 12.
- Castle Annell, Limerick Nationalist demonstration proclaimed.—Dec. 22.
- Dublin, new museum completed.—Dec. 25.
- Dublin, Zetland Earl of, the new Irish viceroy, enters Dublin in state.—Dec. 14.
- Galway, William O'Brien, M.P., released from jail.—Dec. 20.
- Iron rod hematite, six foot seam of, discovered, at Torbrook, Annapolis, N.S.—Dec. 27.
- ITALY.—Rome, Signor Crispe, Prime Minister, in reply to Signor Ferrari, in Chamber of Deputies, declares the *entente cordiale* to exist between France and Italy.—Dec. 6.
- Fratavilli, anarchist, sentenced to 15 years imprisonment for throwing bomb into Chamber of Deputies.—Dec. 21.
- Jacobus John Wesley, appointed United States marshal for Southern District of New York.—Dec. 17.
- Japan, tax upon Christian churches removed by Government.—Dec. 1.
- Japan, Yokohama, Ministry reconstructed, charged with introduction of European methods into legal and administrative systems.—Dec. 25.
- JESUITS ESTATES.—Toronto, Mr. Clark Wallace, M.P., Grand Master of Orange Order, on the Jesuit Act and incorporation.—Dec. 4.
- Jewish Ministers' Association, New York, semi-annual conference.—Dec. 16.
- Johnstown, charter for new city of, issued by Governor Beaver.—Dec. 19.
- JUDICIAL.—New York, Peterson Justice, retirement of.—Dec. 1.
- Montreal, Johnson Judge, appointed Chief Justice of the Superior Court, vice Sir Andrew Stuart resigned.—Dec. 10.
- Ottawa, Stuart Sir Andrew, Chief Justice of Superior Court, resignation of.—Dec. 10.
- Quebec, Gagné J. A., ex-M.P.P. for Chicoutimi and Saguenay, appointed Judge of Superior Court of Quebec.—Dec. 10.
- Washington Judge Braver of Kansas elevated to Supreme Court at.—Dec. 4.
- Kingston, Ont., water rates in, reduced 25 p.c.—Dec. 6.
- Károlyi Count, lights duel at Pesth with Count Lazaro.—Dec. 9.
- Károlyi Count, Aloys de Nagy, Károlyi formerly Austrian Ambassador to Great Britain and Germany, killed whilst hunting.—Dec. 27.
- Kennan George, representative meeting at Philadelphia resolve to raise testimonial to.—Dec. 14.
- Knight Templars, Cleveland, Oriental Commandery No. 12 Knight Templars, 23rd annual installation.—Dec. 2.
- Kunze John, found guilty of manslaughter on indictment for murder of Dr. Cronin of Chicago, and sentenced to 3 years in penitentiary.—Dec. 16.
- Labor, American, Federation of, Boston, session of, opened at.—Dec. 10.
- Lawson Guillermo, appointee to U.S. states consul at Halifax approved by Queen.—Dec. 5.
- Lay R. G., appointed consul general of United States at Ottawa.—Dec. 4.
- LEGAL.—Albany, Nov. 26, Thomas Platt removed from the quorum commissionership by decision of Court of Appeals. Nov. 26, reported *N.Y. World*.—Dec. 2.
- Brunswick, claim of alleged legitimate children of late Duke of Brunswick by Countess de Civry to his landed and personal estates dismissed, and that of the King of Saxony and Duke of Cumberland upheld.—Dec. 23.
- Eau Claire, Wisconsin, Telephone Company sues for injunction against the Eau Claire Street Railway Company, and the Sprague Electric Railway and Motor Company, on ground their operations interfere with those of Plaintiff company.—Dec. 13.
- Elizabeth, New Jersey, General M. Drake, publisher of *Daily Leader* found guilty on indictment of libel.—Dec. 10.
- Helena, Montana, test action commenced against State Auditor Kenney, to compel him to the mileage and *per diem* allowance of members.—Dec. 13.
- Indianapolis, Brush Electric Light Company vs. Fort Wayne Jenney Electric Light Company, defendant company enjoined from infringing double business patented by plaintiff company.—Dec. 21.
- Jury system, United States, Maine Jurists favor adoption of Australian system.—Dec. 7.
- Libel, Manchester, Eng., Mackay vs. Manchester *Evening* and *Times* action for, settled by apology of defendant to Mrs. J. D. Mackay.—Dec. 5.
- Libel, Montreal, Ducasse vs. Page, in last case of Judge Champagne, decides that though none but writer and addressee know of contents of libellous letter, action for damages lies.—Dec. 12.
- London, Eng., O'Brien Wm. vs. Lord Salisbury, motion for new trial of, dismissed.—Dec. 23.
- Montreal, action of J. B. Monier of *Le Prix Courant* against F. D. Shallow of *Le Moniteur du Commerce* for damages for misrepresentation, dismissed.—Dec. 3.
- Montreal, Browne Stewart vs. London & Glasgow Insurance Co., action \$20,000 for commission interest.—Dec. 6.
- Montreal, Gregory vs. Lawrence Hague, the Montreal Stock Exchange Court of Review at Montreal upholds decision of Court below compelling Hague to spend to Plaintiff \$2,500.—Dec. 4.
- Montreal, Society of Jesus vs. Mail, motion by Defendants for leave to amend pleadings.—Dec. 5.
- Montreal, Walbank W. McLen, architect, vs. Protestant Hospital for Insane at Verdun, action for cost of plans, etc., dismissed.—Dec. 4.
- Madame Nelson, equestrienne, vs. Northern Pacific Railroad Company, action for bodily injuries settled for \$11,000.—Dec. 7.
- New York, Stewart Cornelia M., deceased, relict of late A. T. Stewart, contest over will of, amicably adjusted. For terms see the *World*.—Dec. 12.
- New York, United States, Brush & Mount Morris Electric Light Company vs. Muyor Grant and others. The Commissioner of Public Works declared by the Supreme Court entitled to cut dangerous and defective wires.—Dec. 13.
- New York, assignment and judgment conferred by Payne, Steek & Co., liquidating jewellers, to preferred creditors declared void by Supreme Court.—Dec. 2.
- Ottawa, Chagoun vs. Normand, Supreme Court dismisses appeal from decision of Queen's Bench, inflicting penalty of \$100 for corrupt electoral practices.—Dec. 4.
- Pittsburg, Cameron & Coal Company, Pennsylvania, receiver appointed of, under mortgage held by Central Trust Company of New York.—Dec. 13.
- Railway contracts, Madison, Wis., Chippewa Valley and Superior Railway Company vs. Chicago, St. Paul, Minneapolis & Omaha Railroad Company and the Chicago, Milwaukee & St. Paul Railroad Company, contract between companies litigated void by Supreme Court of Wisconsin, on ground that it was for lobbying services.—Dec. 3.
- St. John, N.B., Brown vs. St. John *Daily Telegraph Co.*, verdict for plaintiff for \$500.—Dec. 6.
- Silver mine claim, Youngstown, O., the mining suit, Peter L. Kimberly, of Sharon, against Charles D. Arms of Youngstown, settled by agreement.—Dec. 3.
- Toronto, city auditor, comptroller and treasurer, restrained by injunction from paying expenses of entertaining the delegates to the Pan-American Congress in Kansas.—Dec. 2.

## LEGAL.—Continued.

- Toronto, Queen *vs.* Freeman, known as the Tea Traders' Company, conviction of magistrates for infringement of Lottery Act sustained.—Dec. 21.
- United States, D. I. Brewer, of Kansas, appointed by President associate judge of the Supreme Court of the United States.—Dec. 4.
- Winnipeg, Hudson's Bay Company *vs.* Imperial Bank, bill filed to restrain bank from dealing with, \$374,009 of Company's bonds alleged to have been obtained by fraud.—Dec. 4.
- Leuth Otto, found guilty at Cleveland, Ohio, of murder in first degree of Maggie Thompson in May last.—Dec. 27.
- Library, New York, Board of public library trustees, meeting of at.—Dec. 3.
- Liquor Legislation, North Dakota, Prohibition Act passed to operate from July 1st.—Dec. 19.
- Lockport, Bristol, Eng., ten thousand bootmakers locked out.—Dec. 23.
- Lottery, Toronto, conviction of Freeman known as Tea Traders' Company, for infringement of Lottery Act, sustained by Justice Rose.—Dec. 21.
- Longhead J. A., Q. C. of Calgary, appointed to Senate, vice Hon. Senator Hardisty deceased.—Dec. 10.
- Longley, Hon. T. W., Attorney General of Nova Scotia, at Quebec, on the future of Canada.—Dec. 3.
- Lovelard Frank C., appointment as pension agent at New York, confirmed by Senate.—Dec. 12.
- Lynching, Cheranne, Wyo., Kettle Jack's gang of marauders lynched, eleven men hanged, reported.—Dec. 11.
- Macdonald Lady, visits Toronto.—Dec. 5.
- MANITOBA.—Ex-treasurer Brown's resignation accepted by Government of.—Dec. 2.
- Marine Conference, International, Washington, report of committee on life-saving systems.—Dec. 12.
- MARRIAGES.—New York, Charles Jenkins, President of the Manhattan Railway News and Advertising Company, to Miss Kate Duffly.—Dec. 5.
- Columbus, O., Bacon Col. John M., of Seventh U. S. Cavalry, to Miss Mary Denison Forsyth, daughter of Gen. James W. Forsyth of the U. S. Army.—Dec. 13.
- Staten Island, Walker Norman S., jun., to Miss Minnie Wiman, daughter of Ernest Wiman.—Dec. 11.
- Wilmington, Ill., Hetherington James H., ensign of U. S. man-of-war "Michigan," to Miss Bessie Forbes.—Dec. 10.
- Marsh Frederick H., formerly U.S. marshal for the Northern District of Illinois, appointed chief of police in Chicago.—Dec. 21.
- Massachusetts Reform Club, Boston, annual meeting of.—Dec. 7.
- McArthur L. L., U. S. attorney for Oregon, resigns.—Dec. 24.
- McCarthy Dalton, Q. C., M.P., at Ottawa.—Dec. 12.
- McKeen Wm. V., editor in chief of the *Public Ledger*, Philadelphia, silver anniversary of.—Dec. 7.
- McKeen John B., appointed justice of the District Courts of New York, vice Judge Monck deceased.—Dec. 23.
- Merchants Association, Boston, addressed by ex-President Cleveland.—Dec. 12.
- Neredit W. B.'s leadership of opposition endorsed by public meeting at Madoc, Ont., conservative conviction.—Dec. 10.
- MILITARY.—Canada, Kingston, Lieut. J. A. Moore placed on seconded list on appointment as instructor at the Royal Military College at.—Dec. 4.
- Canada, Lieut. Eric Streatfield appointed A.D.C., vice Capt. Wise A.D.C.—Dec. 4.
- Canada, Major Malcolm McAuley to be Lieutenant Col., commanding the 85th (Compton) Battalion, vice Pope, appointed Brigade Major.—Dec. 4.
- National Guard, Columbus, annual report of Adjutant General A xlius filed with Governor.—Dec. 20.
- Philadelphia, annual election of officers of the Grand Army of the Republic of the Department of Philadelphia concluded at.—Dec. 6.
- Rifle Association, annual meeting of Council of, for Province of Quebec, for election of officers.—Dec. 27.
- U.S., Indianapolis, Pension, address of Governor Alam P. Hovey, President of Service Pension Association on Soldiers' Rights; for terms of, see *Cleveland Leader*.—Dec. 3.
- U.S., National Guards of U.S., Columbus, commissions issued by assistant adjutant general Wickham; for list of, see *Cleveland Leader*.—Dec. 3.
- Mining, New Glasgow, Nova Scotia, Yale colliery at, caught fire, and closed to extinguish flames.—Dec. 23.
- Monetary, Washington, silver coinage, interview with Mr. Leech, director of the mint, reported *Cleveland Leader*.—Dec. 9.
- Montana, message of Governor Toole to Senate and Democratic se.—Dec. 18.
- Morley John, M. P., at Dundee, Eng., advocates reform of House of Lords.—Dec. 8.
- Morley John, M.P., at Glasgow.—Dec. 6.
- Morse E. F., engineer and architect, appointed by Mayor of New York as building inspector.—Dec. 26.
- Moussa Bey, charged at Constantinople with murder, arson and pillage in America, acquitted.—Dec. 2.
- Moussa Bey and family exiled to Segrid.—Dec. 9.
- Mowatt Hon. Oliver, at Woodstock, Ont., addresses his constituents.—Dec. 3.
- MURDERS.—Butler, Missouri, United States, Marshall Willis shot by Whitley attempting to arrest Pierce Morgan, a moonshiner.—Dec. 4.
- Atlanta, Ga., Woodward James F., a leading merchant, shot by unknown assailant.—Dec. 26.
- Baltimore, Henry Jones found guilty of murder in first degree of Thomas N. Foster, eight others of manslaughter, two not guilty and not proven as others indicted.—Dec. 23.
- Baltimore, Md., George S. Kay found guilty of murder of Naysae.—Dec. 2.
- Chicago, Cronin, further evidence adduced for defence. Address of Judge King continued.—Dec. 2.
- Chicago, Cronin Dr., Mr. Donahue, counsel for O'Sullivan and Kunze, commences speech for defence.—Dec. 4.
- Chicago, Cronin, Mr. Hynes for prosecution begins his address.—Dec. 5.
- Chicago, Cronin, Wm. H. Hynes opens his speech for prosecution.—Dec. 5.
- Chicago, Cronin, Mr. Forrest addresses jury for defence.—Dec. 9.
- Chicago, Cronin, continuation of Mr. Forrest's address for defence.—Dec. 10.
- Chicago Cronin, State Attorney Longenecker replies for State, and the Court charges jury who retire.—Dec. 13.
- Chicago, Cronin, jury retire to consider their verdict.—Dec. 13.
- Chicago, Cronin verdict, John F. Beggs, not guilty; John Kunze guilty of manslaughter, punishment 2 years in penitentiary; Daniel Coughlin, Martin Bourke and Patrick O'Sullivan, guilty of murder, punishment penitentiary for life.—Dec. 16.
- Cincinnati, Ohio, Bridget Byrnes murdered by John Smith.—Dec. 9.
- Cleveland, Otto Leuth arraigned for murder of Maggie Thompson.—Dec. 2.
- Cleveland, Ohio, Otto Leuth found guilty in first degree of murder of Maggie Thompson, in May last.—Dec. 27.
- Columbus, O., W. Fred. Pettit, Methodist minister of Shawnee, Mo., arrested on charge of poisoning his wife.—Dec. 5.
- France, Nancy, Danga arraigned at, for murder of Sulzer and others.—Dec. 1.
- Glens Falls, N.Y., Harvey Hodge sentenced to death for murder of his wife.—Nov. 3.
- Globe, Arizona, Nahliez, an Apache Indian, for murder of Lieutenant Seward Mott of the Tenth Cavalry, in March, 1887 hanged.—Dec. 27.
- Henry County, Ala., George Brown, wife and three children poisoned by Porter Irwin.—Dec. 8.
- L'Ange Gardien, Can., Ford William, kills his wife and attempts to kill his daughter and his sister-in-law.—Dec. 23.
- Melvale, N.J., John Knox arrested on suspicion of murder of Annie Borden.—Dec. 6.
- New York, Terrala Antoinette, killed in woods by Amanda Bagmote.—Dec. 4.
- New York, Clark Capt. John, found guilty of murder of John Carly in second degree.—Dec. 11.
- New York, Jugigo Shikink sentenced to death for murder of Contaro in February last.—Dec. 16.
- New York, Salley William, found guilty of murder in second degree of Benjamin Hutton.—Dec. 18.
- Niles, Ohio, Charles Shelar kills wife and three children, and then commits suicide.—Dec. 22.
- Parentum, Pa., Rutlet Mrs., murdered by burglars.—Dec. 23.
- Philadelphia, McClafferty John, found guilty of murder of Patrick Haggerty.—Dec. 19.
- St. John, N.B., McDonald Wm. J., arraigned for murder of Mrs. Catherine Macrae.—Dec. 7.
- St. Louis, Casper Clippy shoots John Anson and his daughter, and then commits suicide.—Dec. 7.
- St. Louis, Gueuther Geo. A., by his son.—Dec. 17.
- Somerset, Ky., Hugh Elliott murders Carter Hayden, Mrs. Easter and daughter, and Robert Elliott.—Nov. 29.
- Music Teachers' Association, New York, first annual meeting of.—Dec. 26-28.
- National Fishery Association, Annual Meeting of, at Boston.—Dec. 4.

NAVAL.—United States, Capt. L. G. Sheppard, U.S.R.C.S. of the "Rush," appointed chief of the Revenue Marine Service.—Dec. 16.  
 American Evolution Squadron arrives at Lisbon.—Dec. 23.  
 Lisbon, Baltic Sea, Russia commences new naval fort on.—Dec. 23.  
 Newfoundland, new ministry of, formed, Attorney General and Premier Sir William V. Whiteaway; for holders of other portfolios see Public Ledger.—Dec. 28.  
 Nicaragua, Costa Rica, Honduras, San Salvador and Guatemala seek to unite in one Republic under name of United States of Central America.—Dec. 4.  
 North Dakota, Bismarck N. D., convention of Legislature.—Dec. 3.  
 North Dakota Legislature, Liquor Prohibition Act passed, to come into operation July 1st.—Dec. 19.  
 Nun of Kenmare, (Miss M. J. Cussack) charges cruelty in Ursuline convent at Pittsburg, Pa.—Dec. 6.  
 O'Doherty Dr., appointed bishop of Derry, Ireland.—Dec. 23.  
 Ohio, Soldiers' and Sailors' Home, Columbus, annual report of, lodged with Governor.—Dec. 2.  
 Orlando-Smith General, appointed president of the Cincinnati, Baltimore and Ohio South Western Railway.—Dec. 24.  
 O'Sullivan Patrick, with Martin Bourke and Daniel Coughlin found guilty of murder of Dr. Cronin of Chicago, and sentenced to imprisonment for life.—Dec. 16.  
 Ottawa, Lay R. G., appointed U. S. Consul General at.—Dec. 4.  
 Paris, Comte de, takes up his residence at Stowe House, Buckingham.—Dec. 10.  
 Parkes Sir Henry, at Sydney, on Australian Federation.—Dec. 10.  
 ARNELL, G. S., at Nottingham, Eng.—Dec. 10.  
 Parnell C. S., at Nottingham, Eng.—Dec. 17.  
 Peabody Captain W. W., appointed vice president and general manager of the Baltimore and Ohio South Western Railway.—Dec. 24.  
 Pedro Dom, ex-emperor of Brazil, banished by proclamation.—Dec. 21.  
 Peters Dr., and Lieutenant Liedmann, African explorers, reported in Zanzibar, to be dead.—Dec. 2.  
 Pettit W. Fred, Methodist minister, arrested at Columbus, O., on charge of murdering his wife.—Dec. 5.  
 Peterso Mr. Justice (New York), retires from judicial Bench.—Nov. 30.  
 Pinto Major Serpa, recalled by Portuguese Government, in response to British demand.—Dec. 27.  
 Pittsburg, Pa., Ursuline Convent at, the Nun of Kenmare (Miss Cussack) charges cruelty in.—Dec. 6.  
 Platt Thomas, by decision of the Court of Appeals, Albany, is removed from Guarantee Commission, Nov. 26; reported N. Y. *World*.—Dec. 4.  
 Pope C. R., appointment as Consul for United States at Toronto, approved by Queen.—Dec. 5.  
 Portugal, Lisbon, rumoured revolutionary movement said to be caused by success of the revolution in Brazil, officially denied.—Dec. 2.  
 Portugal, Lisbon, British opposition to Portuguese ascendancy in Marston abund resented at.—Dec. 1.  
 Pottery Central, under name of Akron & Canton Stoneware Agency, established at Akron.—Dec. 1.  
 Press Club, New York, Col. John Cockell re-elected president.—Dec. 2.  
 Preston Charles M., of London, appointed superintendent of banks for United States.—Dec. 23.  
 RAILWAYS.—C. B. & D. Railway take over the Indianapolis Decatur, and Western Ry., extending from Indianapolis to Decatur, Ill.—Dec. 3.  
 Canso, N.S., C. P. R. Railway Co. complete telegraph communication between Montreal and Canso, N.S.—Dec. 18.  
 C. P. R., traffic returns for week ending Nov. 70 \$412,000, as against \$391,000 in corresponding week of 1888.—Dec. 4.  
 Chicago, Annual conference of Railway Passenger and Freight Conductors' Mutual Aid and Benefit Association at.—Dec. 2.  
 Chicago, Burlington and Northern road announce reduction in rates to commuters Jan. 1.—Dec. 28.  
 Chicago, Milwaukee and St. Paul Railroad reduce passenger rates.—Dec. 30.  
 Chicago, Western States Passengers' Association decide to advance eastbound passengers' rates from Dec. 15.—Dec. 4.  
 Cincinnati, Baltimore and Washington Railroad re-organized with capital of \$3,000,000, under name of the Baltimore and Ohio South Western Railway.—Dec. 24.  
 Columbia, S. C., Receiver appointed under mortgage to F. W. Bound, of the South Carolina Railroad.—Dec. 5.  
 Hudson Bay Railway files bill against Ross and others for injunction against dealing with, \$374,000 of Plaintiff Company's stock alleged to have been procured by fraud.—Dec. 3.  
 Lobbying contract, contracts between litigating companies in the cases of Chippewa Valley and Superior Railway Com; any ex. Chicago, St. Paul, Minneapolis and Omaha Railroad Company, and the Chicago, Milwaukee and St. Paul Railroad Company, voided by Supreme Court of Wisconsin, on ground that it was for lobbying services.—Dec. 3.

## RAILWAYS.—Continued.

Memphis, Rapid Transit Company incorporated with capital of \$2,000,000.—Dec. 20.  
 Mexican Continental Railway subsidized by the Government to extent of \$25,000 per kilo over distance of 1,800 miles.—Dec. 2.  
 New York, Richmond and Danville, presidency of, accepted by Mr. John H. Moran.—Dec. 10.  
 Norristown, Pennsylvania, Schuylkill Valley Railroad Company, and the Philadelphia and Reading Railroad Company, decision in favor of the Reading Co.—Dec. 2.  
 Northern Pacific Railway takes over railway bridge on International boundary connecting Emerson and West Lynn.—Dec. 9.  
 Newark, electricity railway on new principle laid on wharves at (invention of Harry W. Smith)—Dec. 2.  
 Nicolet, Drummond County Railway opened at, by Bishop Gravel.—Dec. 3.  
 New York, Trunk Line, meeting of presidents of, except Reading.—Dec. 3.  
 Omaha, \$250,000 voted by Legislature towards construction of million dollar railroad bridge over the Missouri river at Omaha.—Dec. 4.  
 Pennsylvania, Poughkeepsie and Boston railroad, first train runs over.—Dec. 6.  
 Philadelphia and Reading Railroad Co., Bail D. H., appointed general freight manager of.—Dec. 2.  
 Quebec, Lower Laurentian Valley Railway, contract to complete, concluded with C. A. Scott.—Dec. 6.  
 Richmond, Va., bill to incorporate the Columbia Railway and Navigation Company introduced into legislature.—Dec. 20.  
 Teanahocque Railroad, New Mexico, loan for, placed in Germany.—Dec. 23.  
 Walhoning Valley Railroad Company incorporated.—Dec. 13.  
 Washington, Interstate Commerce Commission, complaint laid before, by the New York Board of Trade and Transportation, against the Pennsylvania Railroad Company, the Pittsburg, Ft. Wayne and Chicago Railway Company, and the Pittsburg, Cincinnati and St. Louis Railroad Company, charging defendants with exercising preference in paying of freight and other rates.—Dec. 5.  
 West Virginia, Wheeling Bridge and Railway Terminal Company to Washington Trust Company of New York City for \$2,000,000 registered.—Dec. 7.  
 Reading Terminal Bill, Philadelphia, amended and passed by common council of.—Dec. 25.  
 Rimouski, Mr. Tessier elected as Nationalist representative for.—Dec. 4.  
 Riot, Jessop, near Savannah, Ga., race riot at.—Dec. 26.  
 Riot, Nashville, Tenn., race riot at.—Dec. 26.  
 RUSSIA, Siberia, Russian editor, under name of Brant, having escaped from mines at Siberia, arrives at Vancouver, B. C.—Dec. 4.  
 Kwi, Province of, twenty Catholic churches closed by order of Governor.—Dec. 18.  
 Several officers arrested for complicity in a plot against the Czar.—Dec. 18.  
 Salvation Army, headquarters of, in London, Eng., destroyed by fire.—Dec. 2.  
 Samoa, Malieto recognized as king of, by Great European Powers.—Dec. 23.  
 Sandford Henry W., of New York, appointed principal examiner of land claims and contests in the General Land office of United States, vice R. D. Graham, resigned.—Dec. 28.  
 Schulz Lieutenant Auguston, Confederation medal awarded by Dominion Government to.—Dec. 11.  
 Scotland, Dundee, William Arrol of Glasgow, constructor of the Forth and Tay Bridges, presented with freedom of city.—Dec. 23.  
 Serbia, ex-king Milan interdicted by Servian Cabinet from public speaking.—Dec. 4.  
 Shelmore Wm. H., appointment as pension agent, at Philadelphia, confirmed by Senate.—Dec. 12.  
 Sheppard Capt. L. G., of the "Rush," appointed chief of the U.S. Revenue Marine Service.—Dec. 16.  
 SHIPPING, Buffalo, meeting of managers of the Lake Carriers.—Dec. 5.  
 Brigantine Rocks, N.Y., "Hattie Baker" lost on.—Dec. 20.  
 Cape Horn, British ship "King Robert" destroyed by fire.—Dec. 5.  
 Cheboygan, Michigan, despatches from, report wrecks of the "Troja," "Queen" and "Whitney" on Gray's Reef.—Dec. 1.  
 Chincoteague Light, Virginia, ferryboat "Grotton" burned at sea.—Nov. 20.  
 Collier Rock, Columbia River, Oregon, British ship "Clan Kenzie" sunk by Union Pacific steamer "Oregon."—Dec. 27.  
 Digby Cut, N.S., schooner "Leonia" wrecked on, Captain Charles Porter and a sailor drowned.—Dec. 27.  
 Havre, France, S.S. "Prinz Wilhelm L." run down by unknown vessel with thirteen of crew missing.—Dec. 20.  
 Holyhead, Wales, barque "Teuley Castle," eleven drowned.—Dec. 18.

## SHIPPING.—Continued.

Hong Kong, British steamer "Ancona," and Chinese steamer "Kung pai" in collision at.—Dec. 4.

Isle of Wight, British steamer "Cleddy" collides with the "Isle of Cyprus," the "Cleddy" sinks, 13 persons missing.—Dec. 20.

Lake Ontario, the "Eric Stewart" lost on.—Dec. 4.

Pacific S.S. "China" from Yokohama to San Francisco makes journey in 12 days 11 hours, beating trans-Pacific record 1 day 3 hours.—Dec. 6.

Port au Basque, French barque "Angelique" totally wrecked at.—Dec. 8.

Puget Sound, S.S. "Michigan" wrecked off an Enterprise Rock.—Dec. 11.

Samoa, bill for relief of sufferers in wreck of United States' men of war "Trenton" and "Yanholis," and stranding of S.S. "Napoli" in March last at, introduced into Senate by senator Hall.—Dec. 5.

Switzerland, company for running steamer to East Africa subsidized by Swiss Bundesrath.—Dec. 5.

Washington, marine conference at.—Dec. 4.

Yaquina City, Ore.—Three Swede sailors washed overboard from steam schooner "Farillone," and drowned.—Dec. 25.

Shurtleff W. C., of Waterloo, Ia., appointed cashier to Sergeant of Arms of House of Representatives.—Dec. 12.

Silcott Edward, clerk to House of Representatives, Washington, absconds, leaving defalcation of \$93,000.—Dec. 1.

Silcott C. G., indicted, grand jury of Washington for grand larceny and forgery.—Dec. 30.

Silver Coinage, Mr. Leech, director of the Mint, Washington, expresses his views on, to reporter of the United Press; see *Cleveland Leader*.—Dec. 9.

Slavery, traffic in, resolutions of suppression of, discussed at Brussels, see *SS Belgium*, Brussels.—Dec. 2.

Socialism, Karlsruhe, Herr Guttenstein, public prosecutor of Grand Duchy of Baden, declares himself a socialist.—Dec. 21.

Socialists, Germany, committee of Reichstag on socialist bill reject, clause on expulsion declared essential by Government.—Dec. 4.

South Dakota, Fry Cyrus J., appointed marshal of.—Dec. 19.

Spain, Madrid, famine anticipated from failure of crops.—Dec. 6.

Spinnets, Fall River, Mass., National Mule Spinnets' Association of America formed at.—Dec. 15.

SPORTS, Baseball, Boston, Mass., Harvie Richardson signs with the Boston Players' League Club.—Dec. 4.

Baseball, Cleveland, Annual Meeting of Cleveland Baseball Club at.—Dec. 3.

Baseball, Indianapolis, League Team, Charles Miller of Canton contracts to play for.—Dec. 2.

Baseball, New York, Gilbert Hutfeld signs with the New York Club of the National Players' League.—Dec. 26.

Baseball, Philadelphia, E. L. Delahuntz contracts to play for National League next year.—Dec. 2.

Boxing, Boston, New London, Conn., George Dixon a negro beats Eugene Hornbacher.—Dec. 27.

Boxing, Burgos, fight between Smith and Slavin won by Smith.—Dec. 23.

Boxing, Hoboken, benefit for Tommy Kelly the Harley Bantam.—Dec. 2.

Boxing, New York, 110 pound championship of New York, won by Matt Lee in fight between him and Jerry Barnett.—Dec. 23.

Boxing, Sullivan J. L., contracts with Harry Milner to box in two of his theatres with Joe Lawson for \$2,150 per week.—Dec. 5.

Boxing, Boston, light weight battle between Mr. McAniff of Williamsburg, N. Y., and Mike Daly of Bangor, Me., drawn.—Dec. 5.

Boxing, Peoria, Ill., Athletic Association of make up purse for Saltorn & Jackson to fight there.—Dec. 11.

Boxing, Purvis, Mass., Kilein (who appealed) fined \$200 for assault and battery, the jury throwing out count for prize fighting.—Dec. 11.

Boxing, Stamford, Conn., Austin Gibbons beats Mike Cushing in fight for \$1,000 purse after 24 rounds.—Dec. 17.

Chess, Ottawa, International Chess journey between Canada and the United States won by Americans.—Dec. 12.

Curling, Montreal, annual meeting for election of officers of Curling Club at.—Dec. 14.

Foathball, Princeton, N. J., E. A. Poe re-elected captain of University eleven.—Dec. 4.

Racing, New York, National Trotting Association, meeting of, at.—Dec. 3.

Racing, New York, New York Trotting National Association of, Board of Review considers the Nelson-Alagon dispute, adjourned conclusion to February.—Dec. 5.

STANLEY H. M., reaches Bagamaya.—Dec. 1.

Arrives at Zanzibar.—Dec. 6.

Queen Victoria writes letter of congratulation to.—Dec. 12.

STORMS, Austria, traffic blocked by snow for 36 hours.—Dec. 2.

California, rain storms damage Santa Fe and Southern Pacific Railway lines to extent of \$200,000 and \$450,000 respectively.—Dec. 20-26.

Los Angeles, California, Nadeau Vineyard destroyed by breaking of levee on Cal Angelo's river, damage \$100,000.—Dec. 26.

Lake Ontario swept by several bad storms wrecked.—Dec. 4.

Present, Ariz., immense damage done by heavy rainstorms.—Dec. 10.

Sado, terrible typhoon sweeps island of, reported.—Dec. 1.

Sydney, New York, barn of People's Street Railway Company levelled by assistant superintendent Charles A. Nichols killed.—Dec. 26.

STRIKES, Bristol, Eng., Dock laborers' strike settled by compromise.—Dec. 4.

Belgium, strike of miners ends.—Dec. 20.

Berne, Switzerland, printers strike for higher wages.—Dec. 12.

Cork, Ireland, railway porters on strike rest no work on concession of their demands.—Dec. 13.

Dortmund, Germany, coal mine directors concede claims of strikers.—Dec. 13.

Essen, coal miners from Rockburn, Gelsenkirchen and Dortmund Westphalia, resolve to strike.—Dec. 6.

London, Eng., Lord Mayor Isaacs and Cardinal Manning agree to mediate in coal porters' strike.—Dec. 11.

London, Eng., Gasworkers, 1780, 80 out.—Dec. 13.

London, Eng., threatened gasworkers' strike adjusted.—Dec. 12.

Louisville & Terre Haute and Evansville and Indianapolis railroads, freightmen on strike.—Dec. 30.

Milton, New Hampshire, strike of employes of Varney & Lane, shoe manufacturers, ended by concession of higher wages.—Dec. 21.

Monongahela Valley, miners resume work.—Dec. 23.

Savannah, Ga., steelworkers on strike at.—Dec. 11.

Sugar Refining, Philadelphia, Claus Spreckle's refinery with plant of over \$7,000,000 opened.—Dec. 9.

Sugar Company, American, Kansas, projected sugar swindle exposed.—Dec. 12.

Sugar, Topoka, Kansas, Kingman County Sugar Company incorporated with capital of \$500,000.—Dec. 21.

SUICIDE.—Asphyxiation, Bates E. S., law student of Watertown, Mass., by turning the gas tube into his mouth.—Nov. 30.

Albany, N. Y., Allen J. B., ex-Post Office official.—Dec. 17.

Binghamton, N. Y., Wesley A. son, well-to-do farmer.—Dec. 25.

Brooklyn, Stewart Mrs., heiress wife of superintendent of the New York Central Company.—Dec. 28.

Chester, Horsley Geo., of Elmora, Ont., arrested for fraud, commits suicide at.—Dec. 11.

Chicago, Baker James, of Pittsburg, Pa.—Dec. 4.

Flournoy, Ariz., three out of five Indians sentenced to be hanged commit suicide in their cells.—Dec. 4.

Larchwood, Iowa, Munroe Dr., commits, after fatally wounding his wife.—Dec. 24.

Lowell, Mass., Nichols Miss Sarah E.—Dec. 25.

Washington, Gowen Franklin E., of Philadelphia, eminent lawyer.—Dec. 14.

Hartford County, North Carolina, Britt Capt. A. George.—Dec. 9.

Hesperia, Ont., McKenzie Alexander, cuts his throat.—Dec. 9.

Fall Lancaster, O., Charles L. Crippen, by leaping through bedroom window.—Dec. 12.

Kalamazoo, Mich., Mills Mrs., wife of Rector of St. Luke's Episcopal Church at.—Dec. 2.

Lawrence, Mass., Goodwin John, of Goodwin Bros., merchants, by drowning.—Dec. 11.

Leavenworth, Kansas, Taylor Dr. S. F.—Dec. 3.

Milwaukee, Schattenberg August, secretary of School Board.—Dec. 7.

New York, Stewart S. A., of Newark, N. J., by asphyxiating himself with gas from a bedroom jet.—Dec. 4.

Philadelphia, Lyons Augustus T., foundry foreman.—Dec. 13.

Pittsburg, Pa., Chaffy William B., broker.—Dec. 21.

Providence, Rhode Island, Joseph Stott, jeweller.—Dec. 21.

Mount Vernon, Michigan, Willum Major commits, after killing his daughter and granddaughter, and mortally wounding his wife.—Dec. 27.

## SUICIDES.—Continued.

- Niles, Ohio, Charles Sheelar commits, after murdering his wife and three children.—Dec. 22.
- St. Louis, Casper Clippy, after killing John Anson and his daughter.—Dec. 7.
- Washington, Daly John, the murderer of Joseph C. G. Kennedy, hangs himself in hospital.—Dec. 9.
- Washington, Gowen B. Franklin, lawyer, and ex-president of the Philadelphia and Reading Railroad Co.—Dec. 14.
- Switzerland, Berne, Federal Assembly, M. Louis Huchonnet of the Canton of Vaud, and Dr. R. Welti of that of Argau, elected respectively President and Vice-President of the Republic for 1890.—Dec. 10.
- Talmage Rev. Dr., preaches at Jappa, the birthplace of Sewing societies.—Dec. 1.
- TELEGRAPH.—New York, Western Union Telegraph Co. increase ordinary quarterly dividend of  $\frac{1}{2}$  per cent. by  $\frac{1}{4}$  per cent.—Dec. 11.
- Communication of, between Canada, N.S., and Montreal completed by C.P.R. Co.—Dec. 17.
- THEATRICAL.—Chicago, Auditorium opened.—Dec. 9.
- Thomas Arthur L., appointed Governor of Utah.—Dec. 19.
- Tossier Mr., elected as Nationalist representative for Rimouski.—Dec. 4.
- Trade Protection, association for protection of wholesale dry goods merchants formed by Board of Trade, Montreal.—Dec. 3.
- TRUSTS.—St. Louis, the Quick Meal Store Company threatened by Secretary of State with withdrawal of their charter unless they withdraw from trusts or combine to fix prices.—Dec. 3.
- Washington, bills prohibiting, introduced into Senate.—Dec. 4.
- Turkey, Constantinople, Moussa Bey, charged with murder, arson and pillage in America, acquitted.—Dec. 2.
- Twiggs Bishop, of Roman Catholic Diocese of Pittsburg, death of, at Altoona Springs, Pa.—Dec. 8.
- UNITED STATES.—Columbus, National Silver Convention, report of Judge W. H. West, Ohio, delegate to, submitted to Governor Foster.—Dec. 2. For report see *Cleveland Leader*.—Dec. 3.
- Philadelphia, Bankruptcy Bill, Mr. L. J. Torrey explains provisions of, at Board of Trade.—Dec. 1.
- Civil Service commission, sixth report of suit to President.—Dec. 2.
- Congress, opening of.—Dec. 2.
- Congress, message of President Harrison to.—Dec. 3.
- Congress, Senator Dolph introduces bill for fortifications and other defenses.—Dec. 4.
- Congress, select committee on relations with Canada continued for present session.—Dec. 1.
- Congress, standing committees on accounts, on enrolled bills, and on rules appointed by speaker.—Dec. 5.
- Congress, Hartsorn E. J., of Iowa, appointed cashier to sergeant at arms, instead of Silcott.—Dec. 17.
- Congress adjourns to Jan. 6.—Dec. 18.
- House Committee on Ways and Means commence sittings on tariff.—Dec. 25.
- House of Representatives, Democratic caucus of, meeting of.—Dec. 2.
- House of Representatives, message of President Harrison to.—Dec. 3.
- House of Representatives, committee on Rules appointed by Speaker to consist of: The Speaker, Messrs. McKinley, Cannon, Carlisle and Randall.—Dec. 3.
- House of Representatives, committee appointed to investigate accounts of Sergeant at Arms necessitated by default of Cashier Silcott.—Dec. 5.
- House of Representatives, report of special commission on Silcott's frauds.—Dec. 11.
- House of Representatives, bill by Brower repealing tax on tobacco referred to Committee of ways and means.—Dec. 12.
- House of Representatives, bill introduced by Mr. McKinley regulating collection of Customs.—Dec. 16.
- Senate, bill prohibiting fishing by foreign vessels within three leagues of coast line of United States introduced into Senate.—Dec. 4.
- Senate, Trusts, bill for legalizing trusts introduced by Senators Sherman and Bryan and George.—Dec. 4.
- Senate, resolution by Mr. Voorhees, on tariff taxation, laid on table.—Dec. 5.
- Senate, resolution moved by Mr. Plumb, and agreed to for return as to securities by bond of foreign corporations given by employees in the office of the sub-treasury at New York.—Dec. 5.
- Senate, bill to admit Idaho as a State introduced by Mr. Platt.—Dec. 9.

## UNITED STATES.—Continued.

- Senate, resolution by Senator Sherman in favor of settlement of International disputes by arbitration referred to Committee on Foreign Relations.—Dec. 9.
- Senate, Federal election bill introduced by Senator Chandler.—Dec. 10.
- Senate, on report of Finance Committee, the bill to provide for organization of National Bank with less capital than \$20,000 postponed.—Dec. 10.
- Senate, bill by Mr. Evans, providing for Quadro-Centennial celebration of Columbus' discovery of America laid on table.—Dec. 10.
- Senate, service and disability bill introduced by Mr. Ingalls.—Dec. 11.
- Senate, Mr. Green B. Baum as commissioner of pensions, Messrs. Wm. H. Schiomiore and Frank C. Loveland as pension agents at Philadelphia and New York respectively, appointment confirmed by.—Dec. 12.
- Senate, Quadro-Centennial Committee appointed.—Dec. 12.
- Senate, on motion of Mr. Butterworth, the ballot-box contract alleged to be forged was referred to a select committee.—Dec. 12.
- Senate, bill providing for negro emigration to foreign countries introduced by.—Dec. 12.
- Senate, bill for publication of Agricultural Reports for departmental use agreed to.—Dec. 16.
- Senate, appropriations for Public Printing and for the Census Bureau passed.—Dec. 17.
- Senate, extradition treaty with England laid before, by President.—Dec. 17.
- Senate, motion of Mr. Morgan for recognition of United States of Brazil falls through for want of a quorum.—Dec. 20.
- Senate Committee on Canadian affairs, Erasmus Wiman and others examined before.—Dec. 20.
- Washington, George Washington, inauguration of, as first president commemorated.—Dec. 11.
- Washington, Court of claims, report of Attorney General Miller on claims filed under French Spoliation Act.—Reported Dec. 5.
- Washington D.C., Governors of the States and Territories, convention of.—Dec. 10.
- Washington, States Tax Commission, meeting of.—Dec. 12.
- Washington, Attorney General Miller's annual report, synopsis of. See *Philadelphia Ledger*.—Dec. 16.
- Washington, the Under Secretary of Treasury refuses to renew lease of Alaska Sea Fisheries to Alaska Commercial Co.—Dec. 18.
- Washington, for list of minor, diplomatic and consular appointments, see *Cleveland Leader*.—Dec. 21.
- Utah, Robertson R. S., of Indiana, and Alvin Saunders of Nebraska, appointed Utah commissioners.—Dec. 19.
- Utah, Thomas Arthur L., appointed governor of.—Dec. 19.
- Venezuela restores import duty on corn, rice, etc.—Dec. 6.
- Kansas City, Mo., City Council extends area of city by addition of twenty-two square miles of city territory.—Dec. 3.
- Walker Gen. Francis A., elected president of the International Copyright Association, at annual meeting of, at Boston.—Dec. 30.
- Waterway Commissioners, Chicago, first election of board of.—Dec. 12.
- Wheat, corner in all wheat in province of Manitoba secured by the Ogilvie Milling Company, reported.—Dec. 25.
- Wiman Erasmus, on union of Canada and United States, before Senate Committee in Washington.—Dec. 30.
- Workshop and Factories, United States, annual report of State Inspector; for terms of see *Cleveland Leader*.—Dec. 11.
- Youngstown, bill for erection of public buildings introduced into Senate by Senator Sherman.—Dec. 3.
- Zanouville, bill for erection of public buildings introduced into Senate by Senator Sherman.—Dec. 3.
- Wallace Clark, M.P., at Toronto, delivers address on the Jesuit Act and incorporation.—Dec. 6.
- Wheat, Manitoba, rise of wheat of ten cents.—Dec. 5.
- Wholesale Dry Goods Association, Montreal, first annual meeting of, at.—Dec. 3.
- Woodstock, Ont., Hon. Oliver Mowat at.—Dec. 3.
- Wool, Washington, National Association of Growers of, in Ebbett House.—Dec. 2.
- World's Fair, Washington, bill introduced into Senate by Senator Inglis, to aid and secure the commemoration of the fourth anniversary of Chancery of America.—Dec. 5.







